

FT-767GX

FT-767GX



This manual is intended to serve as a technical supplement to the FT-767GX Operating Manual. Detailed information regarding functions, installation, interconnections and operation is provided in the Operating Manual, and is not reprinted herein. Therefore this Technical Supplement is not intended to serve as an independent reference, but to be used in conjunction with the information provided in the Operating Manual.

Because there are over 280 circuit stages in the fully-equipped FT-767GX, circuit description is provided by numerous block diagrams supplementing the schematic diagrams. We trust that this manner of providing functional information will prove more helpful than would a lengthy verbal description. Readers who are unfamiliar with the basic types of analog and digital circuits that serve as the building blocks of the FT-767GX may benefit from studying basic instructional texts published elsewhere, such as in handbooks on amateur radio and digital circuit design, before attempting to understand the design of the FT-767GX. Each block in the block diagrams represents one such basic circuit, with specific circuit details provided in the schematic diagrams.

While we believe this technical information is correct and factual, some errors are bound to be present, and those known at the time of printing have been noted at relevant points in the Alignment Instructions. Yaesu assumes no liability, however, for damage that may result from typographical or other errors that may be present. Readers' cooperation in bringing to our attention any inconsistencies in the technical information is appreciated.

Yaesu Musen strives to keep all officially appointed distributors of the FT-767GX advised of all significant design changes that may be developed, in the interest of technological improvement, during the course of production. Said distributors may elect to incorporate such changes at their discretion. However, neither Yaesu Musen nor its distributors can accept any obligation to advise owners or modify previously produced sets based on such design changes, beyond that which may be required by law.

SERVICE AND ALIGNMENT

The FT-767GX is carefully designed to allow the knowledgeable operator to make all adjustments required for various installations, modes and operating preferences simply from the controls on the front and rear panels, without opening the case of the transceiver. These adjustments are described in the FT-767GX Operating Manual.

The following procedures cover the sometimes critical and tedious adjustments that are not normally required once the transceiver has left the factory. We recommend that these adjustments be made only by authorized Yaesu service representatives, as many are interdependent and difficult to perform correctly without extensive prior experience with this type of procedure. Without such experience and the proper test equipment, any attempt to make internal adjustments may cause degraded transceiver performance, the correction of which is not covered by the warranty policy when caused by unauthorized internal adjustments.

In the unlikely attempt that a sudden failure occurs during normal operation, do not attempt realignment. Such failures are almost always due to the failure of a component, sometimes in and external accessory, or a problem with the antenna system. After all external connections have been checked, if the transceiver is still suspect, the dealer from whom the set was originally purchased should be contacted immediately for instructions regarding repair. Authorized Yaesu service technicians automatically perform complete performance checks and realignment of all circuits that may be affected once a faulty component has been replaced.

Those who do undertake any of the following alignment procedures are cautioned to proceed only at their own risk. Yaesu must reserve the right to change circuits and alignment procedures in the interest of improved performance, without notifying owners. Under no circumstan-

ces should any realignment be attempted unless the normal function and operation of the transceiver are clearly understood, the malfunction has been carefully analyzed and any faulty components replaced, and the need for a specific realignment determined to be absolutely necessary. Procedures not involving adjustments are called 'Checks', and are provided to aid troubleshooting.

The following test equipment (and thorough familiarity with its use) is required for complete alignment. While most steps do not require all of the equipment listed, the interactions of such adjustments may require that more complex adjustments be performed afterwards. Do not attempt to perform only a single step unless it is clearly isolated electrically from all other steps. Rather, have all test equipment ready before beginning, and follow all of the steps in the order that they are listed in each section.

During all of the following procedures that call for the transmitter to be activated (MOX button pressed), a 50-ohm dummy load and in-line wattmeter must be connected to the relevant antenna jack, except where specifically stated otherwise. After the adjustment in any of these steps, return the MOX button to its OFF (out) position before proceeding to the next step. In no case should the MOX button be left depressed for more than the minimum amount of time necessary, which should be less than 30 seconds.

Also, the SHIFT control must be set to the 12 o'clock position, the RF gain control must be fully clockwise, and the SQL control must be fully counterclockwise during all steps, unless indicated otherwise.

After completing each step, read the following step to determine whether the same test equipment will be required. If not, remove the test equipment (except the dummy load and wattmeter) before proceeding.

COVER REMOVAL

- (1) Switch off the transceiver and remove the AC power cable and all other cables from the rear panel.
- (2) Remove the two screws affixing each VHF or UHF Band Module, and slide the Modules out of the transceiver (Fig. 1).
- (3) Remove the two screws at the front of the top cover (heatsink, Fig. 2).
- (4) Place the transceiver upside down, and remove the four screws from the bottom corners and two on either side (including the carrying handle screws). Remove the carrying handle and bottom cover (Fig. 3).
- (5) Referring to Figure 4, remove the 7 black painted screws from the rear panel. Then remove the (black) outer rear panel.
- (6) Referring to Figure 5, remove the 10 screws from the inner rear panel, and remove this panel.
- (7) Remove one screw on either side, as shown in Figure 6.
- (8) Locate the white molex connectors (one for power and one for the speaker) inside the rear of the chassis, and disconnect them.
- (9) Fold the lower half of the chassis away from the upper half, placing a book of about the same thickness of the heatsink under the bottom half as shown in Figure 8.

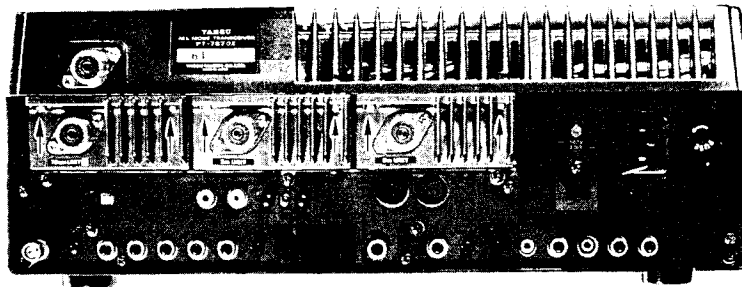

Figure 1

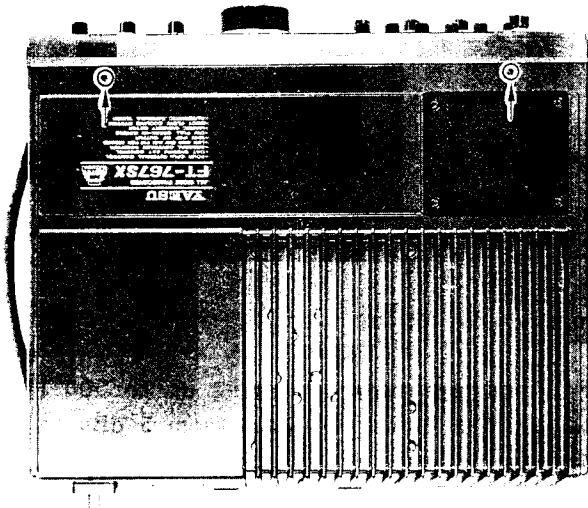

Figure 2

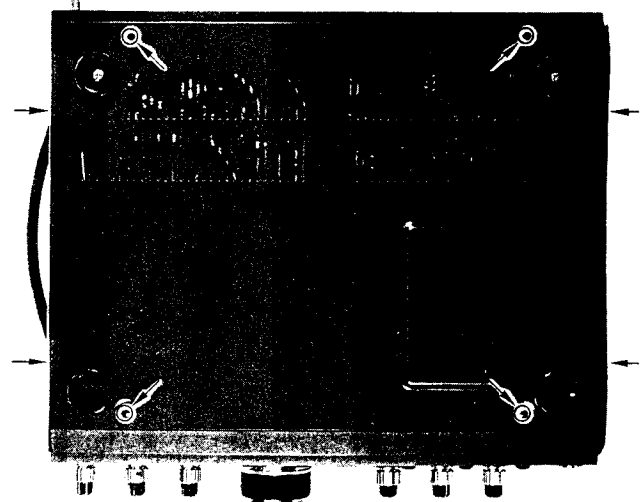

Figure 3

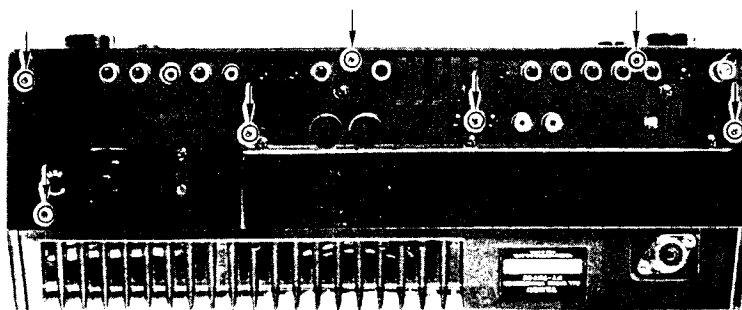

Figure 4

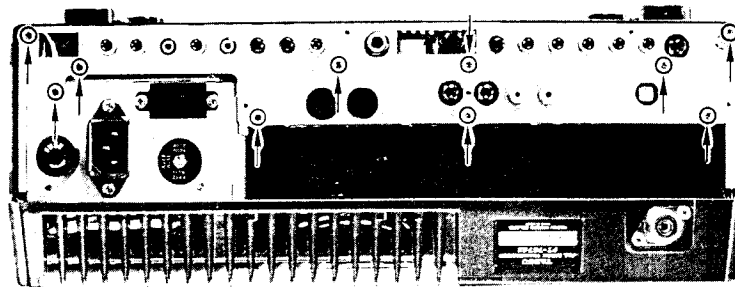

Figure 5

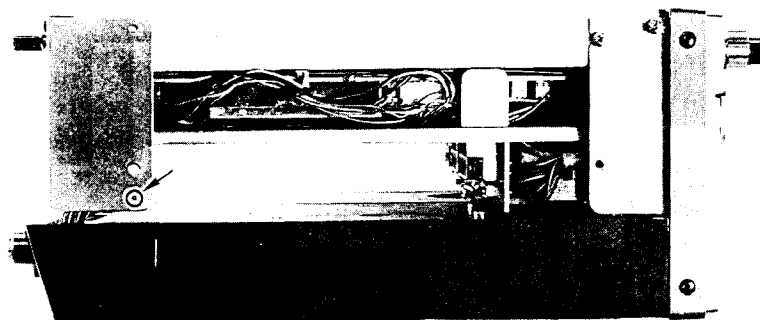

Figure 6

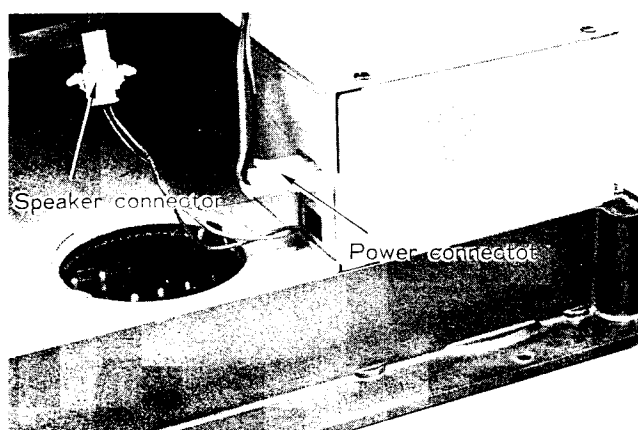

Figure 7

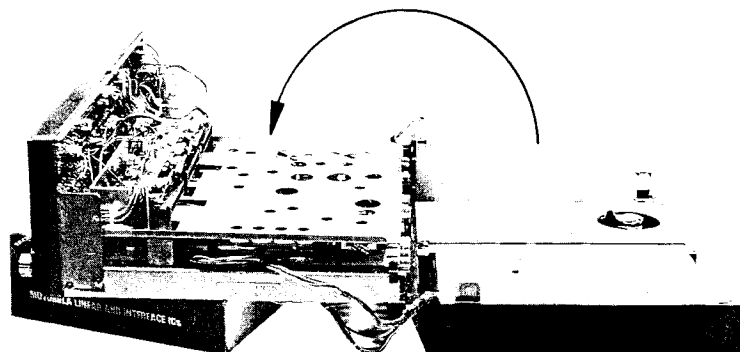

Figure 8

Alignment Equipment

Frequency counter with accuracy of 0.1 ppm to 500MHz

DC voltmeter with at least 10-Megohm impedance

RF voltmeter with at least 5% accuracy to 500 MHz, high impedance, ranging from 10 mV to 3 Vrms, and indicating dB (see note below)

AF millivoltmeter

DC milliammeter ranging to 500 mA.

Spectrum Analyzer or X-Y oscilloscope with 120 MHz bandwidth (for 2m Band Unit Alignment)

In-line RF Wattmeter

50-ohm non-reactive dummy loads: three required, at least 150W Pd.

3-ohm, 60W resistor

RF signal generator covering up to 500 MHz, with calibrated output level from 5 dBu to 100 dBu, and adjustable FM modulation.

AF signal generator with calibrated output level at least from 1 mV to 25 mV.

FM deviation meter/Sinadmeter and RF sampling coupler 'T'.

Linear Detector for up to 30 MHz.

NOTE: All RF voltage measurements are referenced to 0 dBu = 0.5uV @50 ohms relative to chassis ground nearest the measurement point.

POWER SUPPLY

(1) 24V Supply

On the PA Unit, connect the DC voltmeter to J9002 (J8009 for 10W version) and ground. Adjust VR6003 on the PS Unit for $24.0 \pm 0.5V$ while receiving.

(2) 13.5V Supply

On the PA Unit, connect the voltmeter to J9007 (J8007 for 10W version) and ground. Adjust VR6004 on the PS Unit for $13.5 \pm 0.3V$ while receiving.

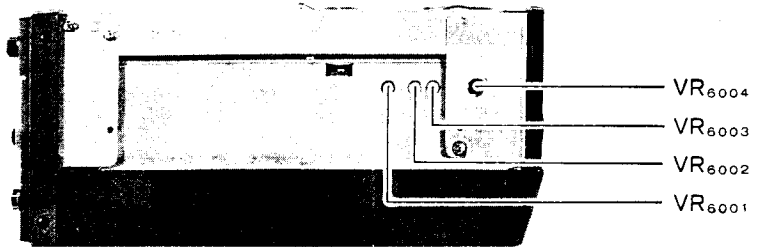

PS UNIT Alignment Points

BOARD LOCATIONS

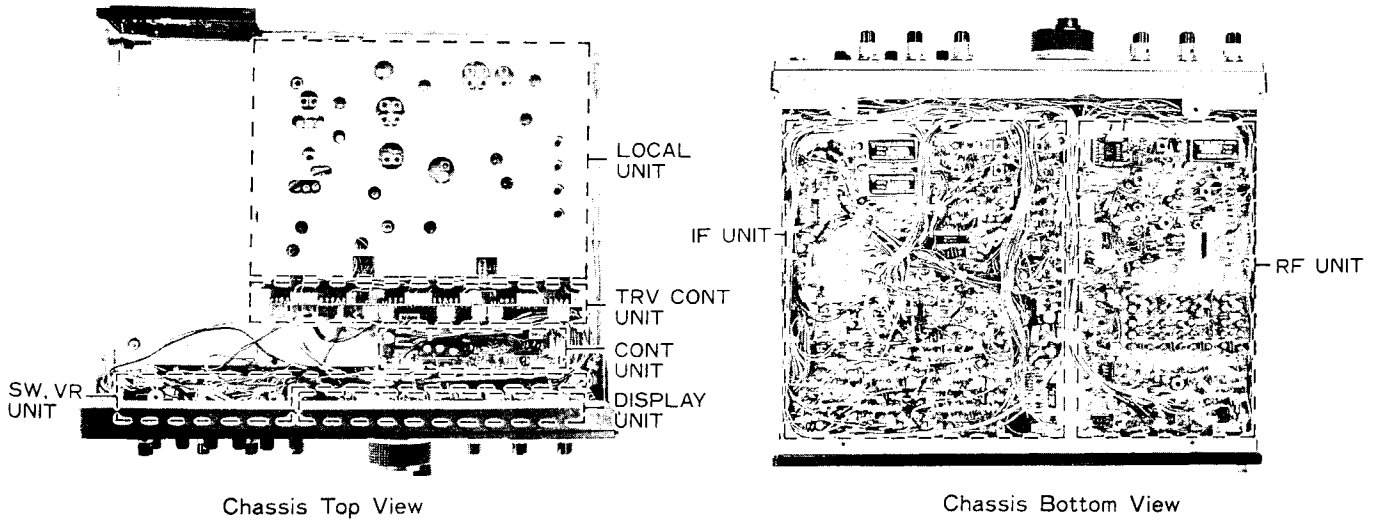

Chassis Top View

Chassis Bottom View

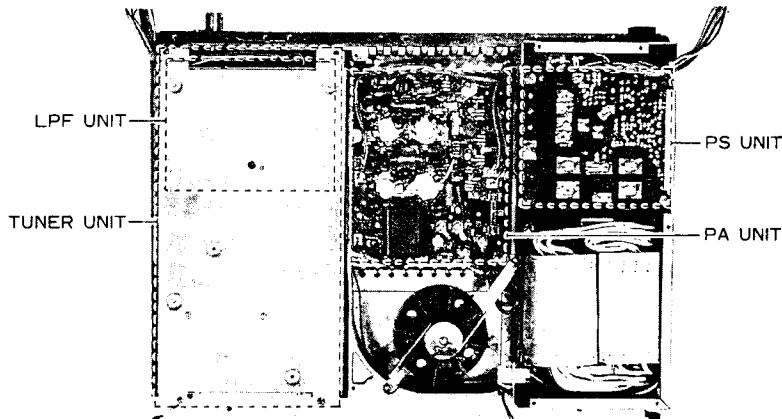

Underside of Heatsink

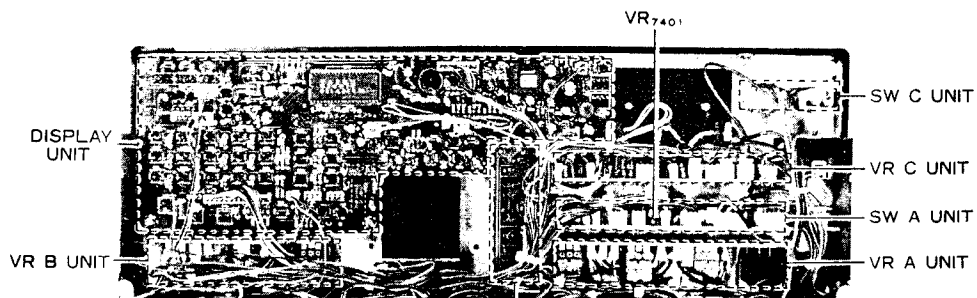

Inside of Front Panel

LOCAL UNIT

Make all measurements and adjustments while receiving in the CW mode, except where stated otherwise.

(1) 3rd Local Oscillator

Connect the RF voltmeter to J3002 and adjust T3023 and T3024 for maximum voltage (at least 50 mVrms).

(2) 45 MHz Bandpass Filter I

Tune to 14.250 MHz and connect the RF millivoltmeter to TP3005. Adjust T3017 and T3018 for maximum RF (at least 50 mVrms).

(3) 60 MHz Bandpass Filter

Tune to 21.250 MHz and connect the RF millivoltmeter to TP3001. Adjust T3014 and T3015 for maximum RF (at least 80 mVrms).

(4) 45 MHz Bandpass Filter II

Tune to 14.250 MHz and connect the RF millivoltmeter to TP3001. Adjust T3012 and T3013 for maximum RF (at least 80 mVrms).

(5) 15 MHz Reference TCXO

Connect the frequency counter to TP3005 and adjust the trimmer accessible through the hole in the TCXO for 45 MHz ± 10 Hz.

(6) 2nd Local Oscillator & D/A Converter

Tune to 14.0000 MHz and connect the frequency counter to TP3007. Adjust TC3001 for 30.03000 MHz ± 20 Hz. Now retune the display to 13.99999 MHz and adjust VR3001 for 30.02901 MHz. Ensure that the difference between the two readings is within 990 ± 5 Hz.

(7a) Carrier Oscillators

Make certain the SHIFT control is set to the 12 o'clock position. Connect the frequency counter to pin 5 of Q3060. Select the mode indicated in the following table, and adjust the indicated coil or trimmer for the indicated frequency on the counter ± 10 Hz.

<u>Mode</u>	<u>Adj. Point</u>	<u>Freq. (kHz)</u>
CW	L3019	6784.100
LSB	TC3002	6786.600
USB	TC3003	6783.400
FSK	TC3004	6787.200

(7b) Transmitter IF Shift

A 50-ohm dummy load must be connected to the ANT jack, as this step requires transmission for measurement and adjustment.

Set the TX SHIFT button OFF (out) and select the LSB mode. Set the TX SHIFT control to the 12 o'clock position. Connect the frequency counter to pin 5 of Q3060. Press the MOX button and adjust VR3002, if necessary, for 6786.6 kHz ± 10 Hz on the counter. Now press the TX SHIFT button and if necessary adjust TC3005 for the same indication on the counter.

(8) CW BFO Frequency

Select the CW mode and connect the frequency counter to pin 2 of Q3060. Set the PITCH selector and adjust the corresponding trimmer for the frequency indicated as follows (± 10 Hz):

<u>Pitch</u>	<u>Adj. Point</u>	<u>Freq.(MHz)</u>
800 Hz	TC3009	15.0008
700 Hz	TC3008	15.0007
600 Hz	TC3007	15.0006

(9) FM Carrier Frequency

A 50-ohm dummy load must be connected to the ANT jack, as this step requires transmission for measurement and adjustment.

Select the FM mode. With the frequency counter connected to pin 2 of Q3060, press the MOX button and adjust VR3003 for 15 MHz ± 50 Hz.

(10) PLL Sub-loop VCO

Tune the display to 13.999.99. Connect the DC voltmeter to TP3003 and adjust T3016, if necessary, for 5.5 ± 0.1 V. Retune the display to 14.000.00 and check for 2 to 3V.

(11) 41/56 MHz Bandpass Filters

Tune to 14.250 MHz. Connect the RF voltmeter to TP3002 and adjust T3002, T3003 and T3004 for maximum RF (at least 25 mVrms).

Retune to 21.250 MHz and adjust T3005, T3006 and T3007 for maximum RF (at least 25 mVrms).

To check for proper bandpass selection, connect the frequency counter to TP3002 and tune to 1.750, 3.750, 7.250 and 10.250, confirming 41 MHz on the counter at each frequency. Then tune to 18.250, 24.750 and 28.250 and confirm 56 MHz on the counter at each frequency.

(12) Main Loop VCOs

Set the display to 0.000.00. Connect the high-impedance DC voltmeter to TP3006 and adjust transformer T3022 for 1.5 ±0.1V. Retune the display to 7.499.00 and confirm 5 to 6V. Repeat the same procedure for the same voltages at the following frequencies:

<u>Display</u>	<u>Xfmr</u>	<u>Confirm</u>
7.500.00	T3021	14.999.00
15.000.00	T3020	21.999.00
22.000.00	T3019	29.999.00

Check that the voltage at TP3006 increases smoothly from 1.5V to about 6V when tuning from 0 to 7.499 MHz, 7.5 to 14.999 MHz, 15 to 21.999 MHz and 22 to 29.999 MHz.

(13) 2nd Local Level

Connect the RF voltmeter across J3001 (do not remove the plug) and adjust T3009, T3010 and T3011 for maximum RF (at least 90 mVrms).

(14) SSB Carrier Point Check (Transmit)

A 50-ohm dummy load and wattmeter must be connected to the ANT jack, as this step requires transmission for measurement and adjustment.

Tune to 14.200 MHz, USB mode. Connect the AF generator to the center pin of the MIC jack, and set for 5 mV output at 1 kHz. Press the MOX button and adjust the MIC gain control for 80W RF output.

Reduce the AF generator frequency until 20W RF output is obtained, and note the corresponding audio frequency. Now increase the AF frequency until 20W RF output is again obtained, and again note the corresponding audio frequency.

The lower frequency should be below 350 Hz, and the upper frequency should be above 2900 Hz. If not, perform procedures (7a) and (7b).

Repeat the above in LSB mode.

(15) 1st Local Level Check

Tune to 14.200.00. Connect the RF millivoltmeter to J3004 (do not remove the plug) and confirm at least 220 mVrms.

(16) VHF/UHF Module Reference Level Check

Set the transceiver to the 50 MHz band. Connect the RF voltmeter to J3005 (don't re-move the plug) and confirm at least 150 mVrms.

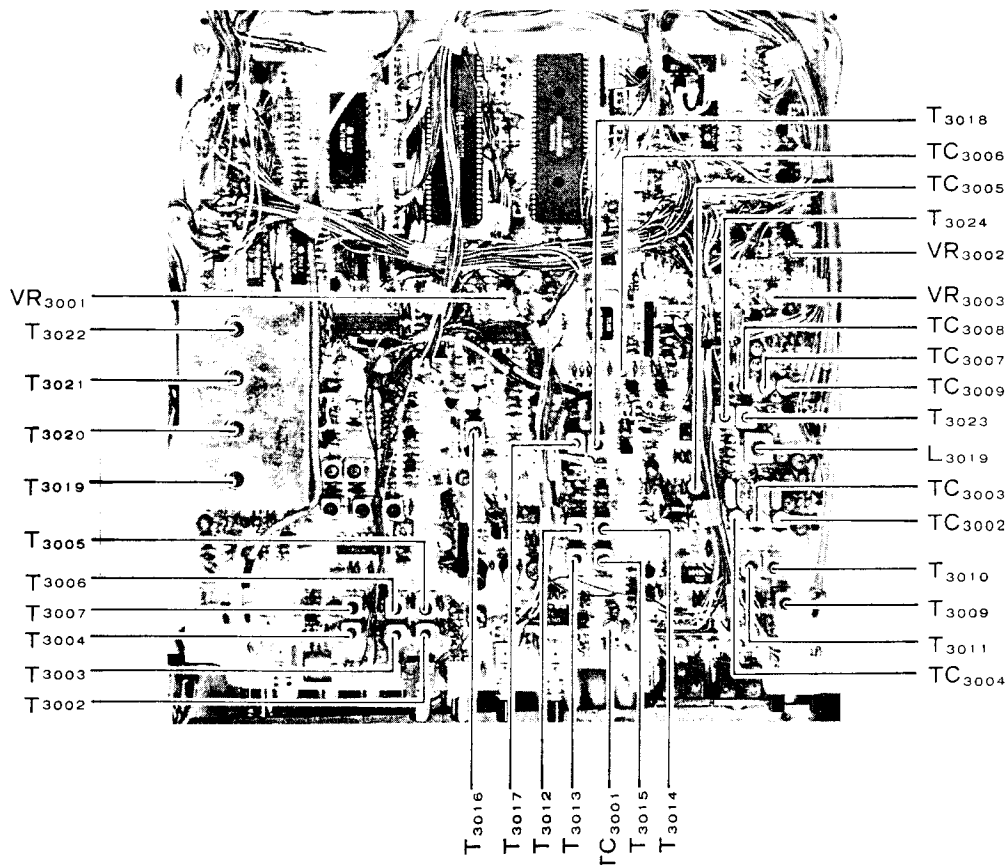

LOCAL UNIT Alignment Points

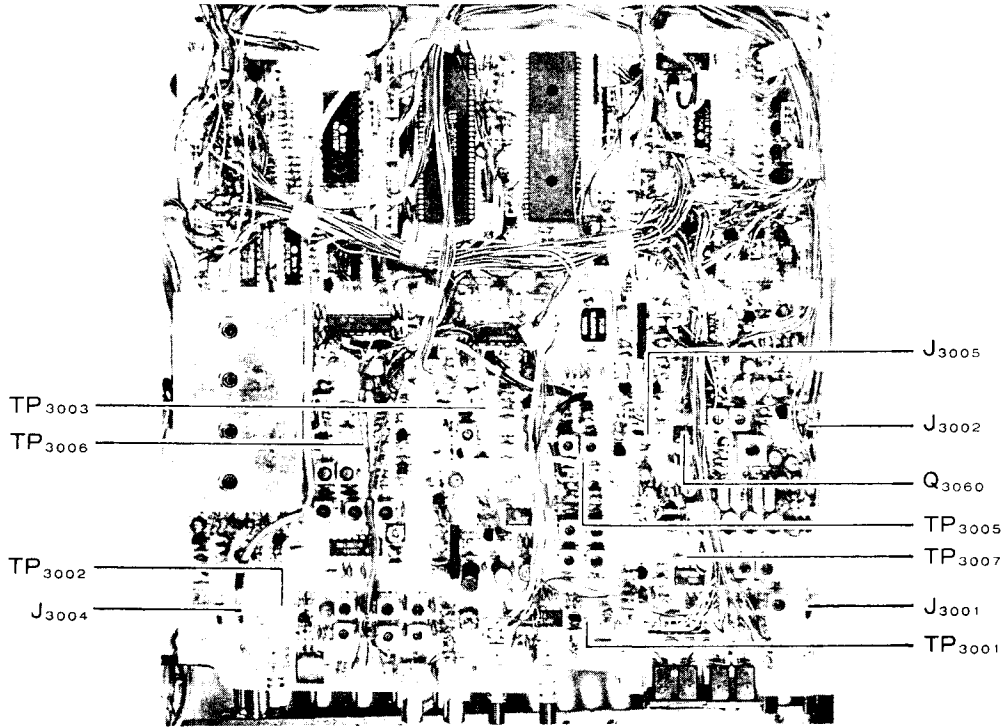

LOCAL UNIT Test Points

LPF UNIT : CM Coupler Balance

A 50-ohm dummy load must be connected to the ANT jack, as this step requires transmission for measurement and adjustment.

Tune to 14.2 MHz CW mode, and set the DRIVE control fully clockwise. Connect the DC voltmeter to pin 2 of J6107, press the MOX button and adjust TC6101 for minimum voltage.

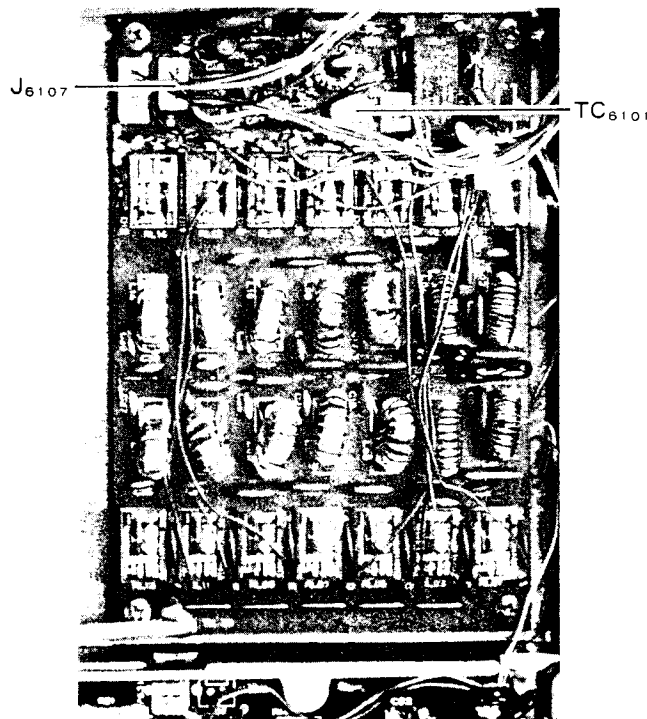

LPF UNIT Alignment Points

IF UNIT

(1) 8.67 MHz Oscillator Frequency (Receive)

Connect the frequency counter and RF millivoltmeter to the base of Q1024. Adjust L1013, if necessary, for 8.670 MHz \pm 50 Hz on the counter, and T1014 for maximum RF.

(2) 3rd Local Level

Connect the RF voltmeter to the emitter of Q1026 and adjust T1015 for maximum RF (at least 300 mVrms).

(3) 2nd Local Level

Connect the RF voltmeter to JP1020 (do not remove the plug) and adjust T1013 for maximum RF (250 to 500 mVrms).

(4) 8.67 MHz Oscillator Frequency (Transmit)

A 50-ohm dummy load must be connected to the ANT jack, as this step requires transmission for measurement and adjustment.

Set the PROC switch ON (depressed), and the TX SHIFT switch OFF. Connect the frequency counter to the base of Q1024. Press the MOX button and adjust VR7401 on the SW A Unit, if necessary, for 8.670 MHz \pm 50 Hz.

(5) Receiver IF Transformers

Remove all connections to the ANT jack, and set the transceiver to USB.

Preset VR1006 (IF gain) fully clockwise and adjust VR1008 for minimum S-meter deflection (on BFO leakage). VR1006 will be realigned in step (7).

Tune the transceiver and RF signal generator to 14.2 MHz, and connect the generator to the ANT jack. Adjust the injection level to maintain mid-scale S-meter deflection while adjusting T2003 - T2005 on the RF Unit, and T1003 - T1010 and T1012 on the IF Unit for maximum S-meter deflection. Repeat these adjustments several times.

(6) IF Filter Compensation

Remove all connections from the ANT jack. To compensate for slight non-symmetry in the SSB IF filters, listen to the receiver while switching between LSB and USB modes, and adjust L1013 (8.67 MHz osc) for the same noise pitch.

(7) IF Gain

With the transceiver and RF signal generator tuned to 14.2 MHz, connect the generator to the ANT jack and set for 6dBu injection. In the USB mode, adjust VR1006 for S-1 indication on the meter.

(8) S-Meter Calibration

While tuned to 14.2 MHz, set the RF signal generator to inject 100dBu at the ANT jack. In USB mode, adjust VR1004 for S-meter deflection to the +60 mark at the right edge.

(9) FM Receive Sensitivity

Connect the SINAD meter in parallel with an 8-ohm resistor to the EXT SP jack. While tuned to 14.2 MHz, set the RF signal generator to inject a 40 dBu carrier with 70% FM modulation of a 1 kHz tone at the ANT jack. Adjust L1007 (may be marked T23 on the schematic, but correct on the silkscreen) for optimum SINAD (minimum deflection) while receiving, FM mode.

(10) FM Receive Audio Volume Preset

Connect the AF millivoltmeter in parallel with an 8-ohm resistor to the EXT SP jack. Tune the transceiver and RF signal generator to 29.2 MHz, and inject an unmodulated carrier at 40 dBu to the ANT jack. In USB mode, adjust the AF gain control for 0.1V on the voltmeter.

Now select the FM mode and modulate the carrier with \pm 3.5 kHz deviation of a 1 kHz tone. Adjust VR1002 for 0.2V \pm 10mV on the voltmeter.

(11) Discriminator Center Meter Calibration

With no signal applied to the ANT jack, set the METER switch to the DISC position and adjust VR1003 for center deflection in FM mode.

(12) FM Squelch Threshold Calibration

With no signal applied to the ANT jack, select the AM mode and set the SQL control on the front panel so that the squelch is just closed. Now select the FM mode and, without moving the SQL control, adjust VR1001 so that the squelch is again just closed.

(13) Noise Blanker IF

Connect the DC voltmeter (10 to 15V range) to gate 2 of Q1001 (with R1001). Tune the transceiver and RF signal generator to 14.2 MHz, and inject an unmodulated carrier at 20 dBu to the ANT jack. Select the USB mode, and press the NB switch on. Adjust T1001 and T1002 for minimum indication on the voltmeter.

(14) IF Notch Resonance

With the RF signal generator tuned to 14.2 MHz, inject an unmodulated carrier at 40 dBu to the ANT jack. Select the USB mode and tune the transceiver for an approximately 1.6 kHz heterodyne on the carrier. Set the NOTCH control to the 12 o'clock position, and the NOTCH button ON. Adjust T1011 and VR1007 alternately for minimum S-meter deflection.

(15) Tone Squelch Threshold (requires FTS-8)

Set the SQL control fully counterclockwise into the T SQL click-stop. In the FM mode, with no signal applied to the antenna, adjust VR1019 so that the BUSY LED just turns off.

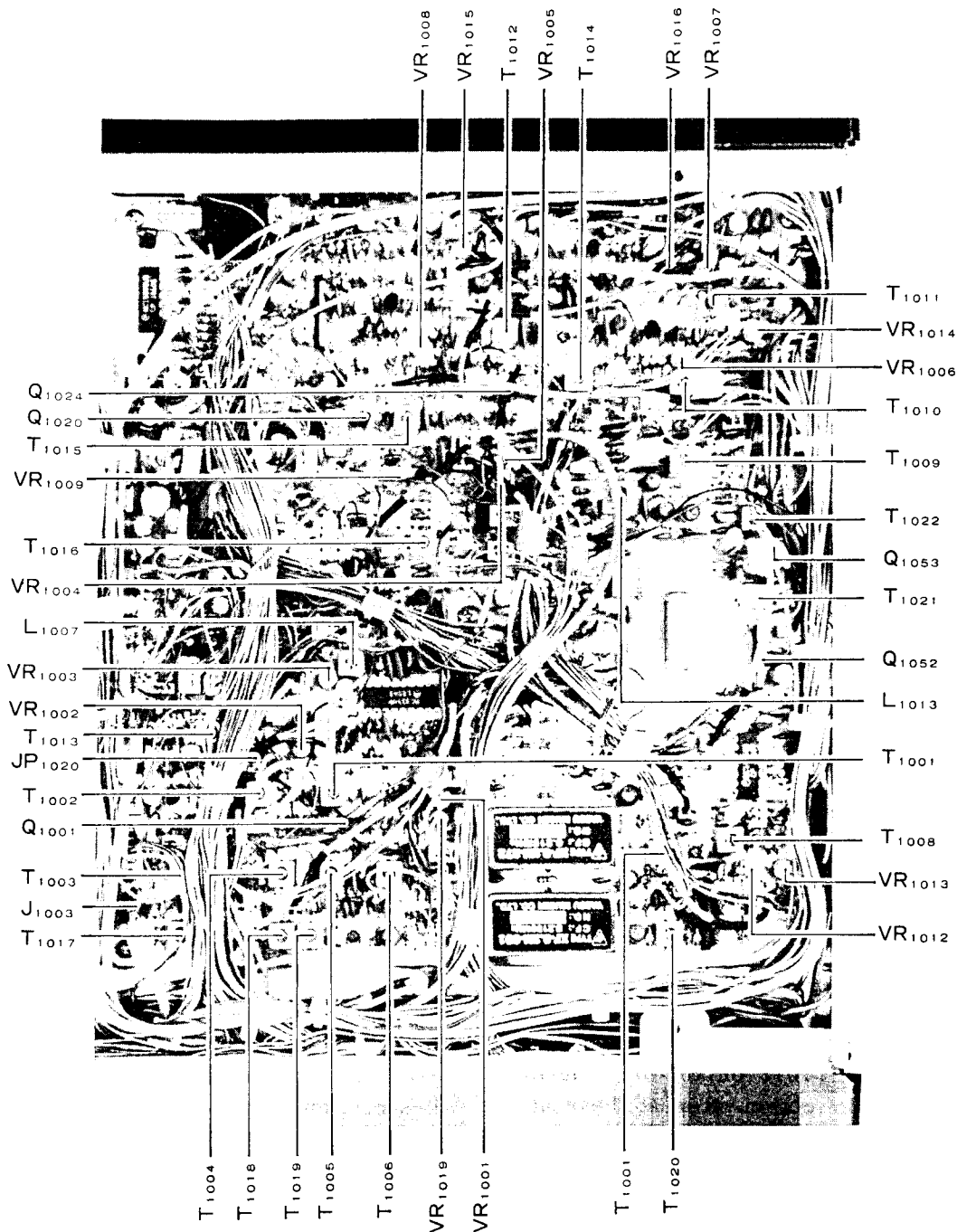

IF UNIT Alignment Points

RF UNIT : Transmitter

A 50-ohm dummy load and in-line wattmeter must be connected to the ANT jack for all of the following procedures. All measurements and adjustments are to be made with the MOX button pressed, while all test equipment connections and tuning or mode selection are to be done while receiving, unless otherwise indicated.

(1) ALC Meter Zero Threshold

Set the METER selector to ALC and tune to 14.2 MHz USB mode. With no microphone input, press the MOX button and set VR2007 to the point just the start of ALC indication.

(2) Transmitter IF Transformers

Preset the DRIVE control to the center of its range. With the METER selector to ALC and tuned to 14.2 MHz, CW mode, press the MOX button and adjust T1020, T1019, T1018 and T1017 on the IF Unit, and T2006 and T2007 on the RF Unit (in that order) for maximum ALC meter deflection.

Note: if no ALC deflection is found at first, perform the adjustments first with the METER selector set to PO, and then repeat for ALC. If the ALC indication is too high, reduce the setting of the DRIVE control.

(3) ALC Level (Maximum Power Output)

With the transceiver tuned to 14.2 MHz, CW mode, set the DRIVE control fully clockwise. Press the MOX button and adjust VR2003 for 100W output on the wattmeter (in the 10W SX version, adjust VR2001 for 10W output).

(4) ALC Meter Sensitivity

With the transceiver tuned to 14.2 MHz CW mode and the METER selector set to ALC, inject 3mV at 1 kHz from the AF signal generator to the center pin of the MIC jack. Press the MOX button and set the MIC gain to the point where ALC deflection just begins. Now increase the AF level to 9mV and adjust VR2008 for full-scale ALC deflection.

(5) PO Meter Calibration

With the transceiver tuned to 14.2 MHz, CW mode, set the DRIVE control for 100W output on the external wattmeter. Press the MOX button and adjust the PO ADJ potentiometer (VR2010) on the rear panel so that the analog meter on the front panel deflects to '8' on the PO scale.

(6) **Automatic Final Protection (SWR turndown)**
Connect a 16.7-ohm dummy load (3 50-ohm loads in parallel) through a wattmeter to the ANT jack. Set the DRIVE control fully clockwise, press the MOX button and adjust VR2005 for 90 \pm 5W on the wattmeter.

(7) Digital SWR/PWR Meter Calibration

While tuned to 14.2 MHz, CW mode, set the DRIVE control for 100W output on the external wattmeter. Press the RF PWR button and the MOX button and adjust VR2002 for 100W on the digital display.

(8) Transverter ALC Level

Set the METER selector to ALC. Connect a 3-ohm, 60W resistor from pin 3 of J2023 to ground. Press the MOX button and adjust VR2009 for full scale ALC meter deflection. Remove the 3-ohm resistor.

(9) VCC (RF PA Collector Voltage) Meter

Set the METER selector to VCC. Press the MOX button and adjust VR2011 so the meter deflects to the middle of the (white) VCC zone.

(10) SSB Carrier Balance

With the transceiver tuned to 14.2 MHz, CW mode, set the MIC gain control fully counter-clockwise. Press the MOX button and adjust VR2012 for minimum power output.

(11) AM Carrier Level

With the transceiver tuned to 14.2 MHz, CW mode, press the MOX button and set the DRIVE control for 80W output. Return to receive, switch to AM mode, press MOX again and adjust VR1012 on the IF Unit for 40W output.

(12) Speech Processor Balance

Connect the RF voltmeter to pin 6 of Q1053 and adjust VR1014 for minimum voltage in an SSB mode with the PROC switch ON.

(13) Speech Processor IF

Set the PROC control to the 9 o'clock position, press the PROC button ON and inject 2mV at 1 kHz from the AF signal generator to the center pin of the MIC jack. Connect the RF millivoltmeter to pin 5 of Q1052 and in an SSB mode, press the MOX button and adjust T1022 and then T1021 for maximum meter deflection.

(14) FM Modulator Deviation

Set up the test equipment as shown below. Pre-set VR1016 fully clockwise, and inject 10 mV of 1 kHz audio to the MIC jack. Press the MOX button and adjust VR1015 for ± 4.5 kHz deviation. Now decrease the AF injection level to 1.5mV and adjust VR1016 for ± 3.5 kHz deviation. Repeat these adjustments at their respective AF levels until deviation at both injection levels is within 100 Hz of the specified values.

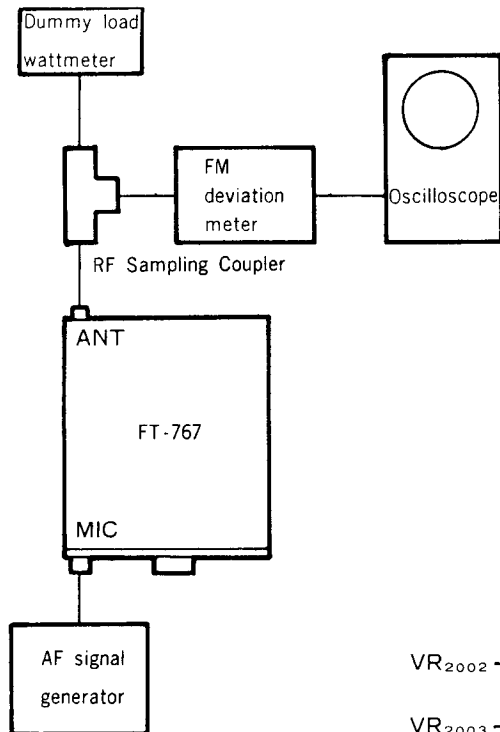

(15) IF Monitor (AM)

With the transceiver tuned to 14.2 MHz, AM mode, set the DRIVE control to the 12 o'clock position. Connect the DC voltmeter to the cathode of D1060, press the MOX button, and adjust T1016 for maximum voltage.

(16) IF Monitor Output Level

With the transceiver tuned to 14.2 MHz, AM mode, set the MIC gain control fully clockwise, MONI button ON, and MONI control to the 12 o'clock position. Connect the DC voltmeter to the cathode of D1060, press the MOX button, and adjust T1016 for maximum voltage.

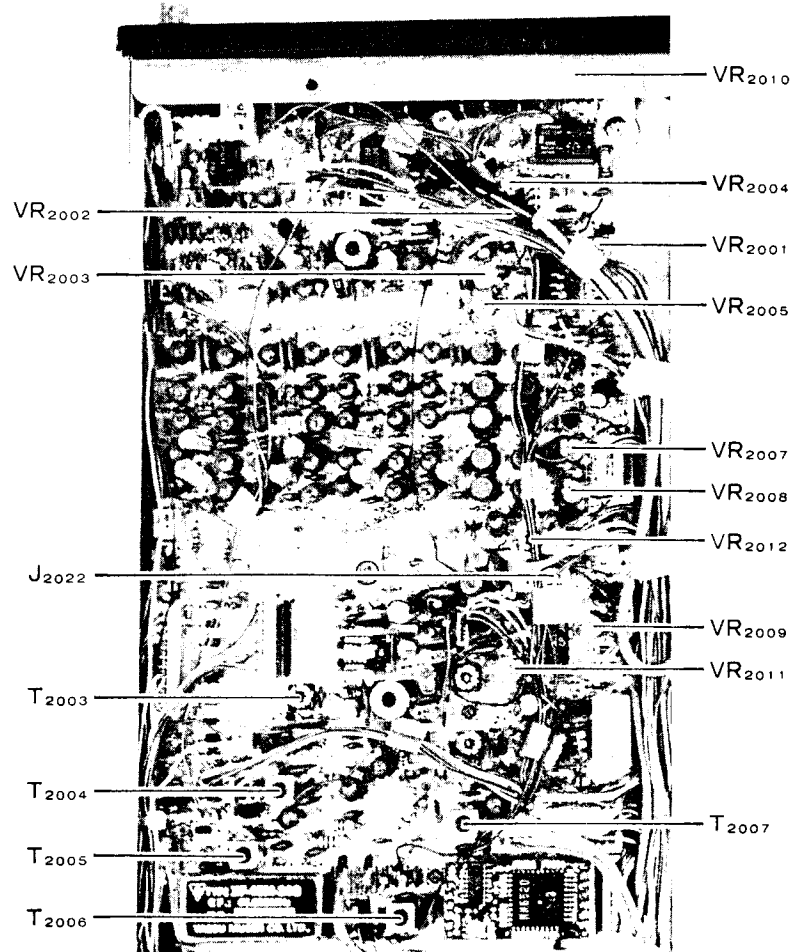

RF UNIT Alignment Points

PA UNIT : Idling Current

Remove the jumper indicated in the diagram below, and connect the DC milliammeter (500mA range) in its place. Set the transceiver to an SSB mode and with no microphone input, press the MOX button and adjust VR9001 for 250 mA. Replace the jumper after adjustment.

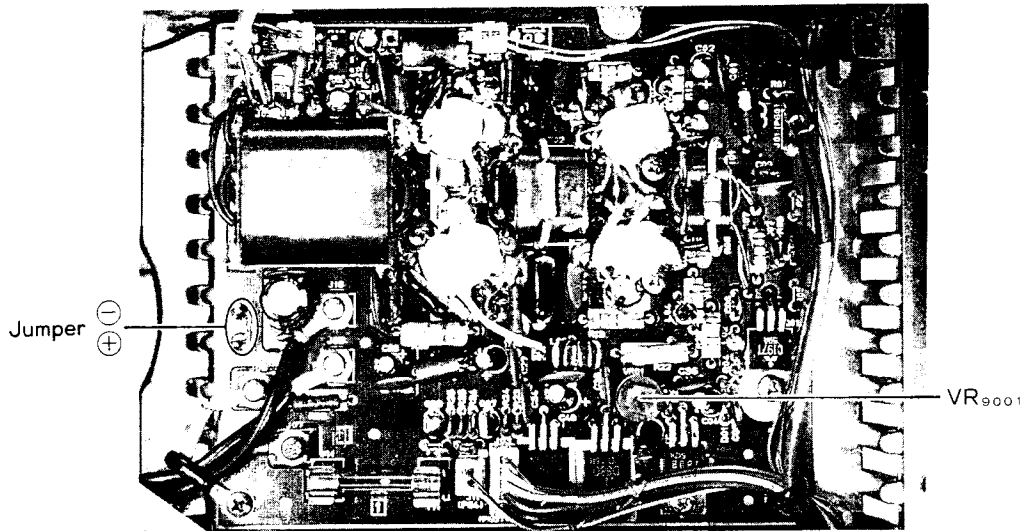

PA UNIT Alignment Points

ANTENNA TUNER UNIT

(1) Variable Capacitor Servos

Preset VR5003 and VR5004 to the center of their ranges. Loosen the shaft-coupler setscrews of VC5001 and VC5002 so they can be adjusted by hand.

While receiving, press the TUNER and START buttons. After the motor stops, manually set VC5001 for minimum capacitance (minimally meshed) and VC5002 for maximum capacitance (fully meshed), then tighten the setscrews.

Press the START button again while receiving, and ensure that VC5001 and VC5002 both rotate throughout at least 180°. When motion stops, note whether both capacitors are fully meshed. If not, adjust VR5003 (for VC5002) or VR5004 (for VC5001) and repeat this step until both capacitors mesh fully when the tuner stops.

(2) Tuner Stop SWR Threshold

Tune to 14.2 MHz, CW mode, and set the TUNER switch OFF. Connect a 16.7-ohm dummy load (3 50-ohm loads in parallel) to the ANT jack, and connect the DC voltmeter to TP5001. Press the MOX button and rotate the DRIVE control gradually clockwise, noting the saturation level beyond which the voltage at TP5001 no longer increases (see diagram below). Adjust VR5001, if necessary, for a 0.5V saturation level.

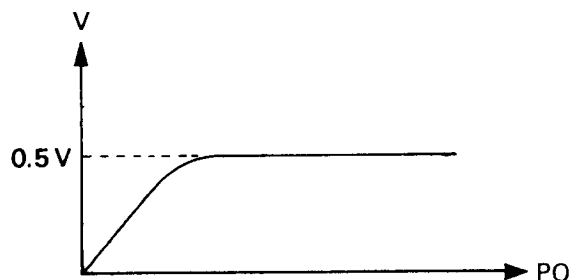

(3) Tuner Auto-Start SWR Threshold

With the transceiver set to 14.2 MHz, CW mode, and 16.7-ohm dummy load as in the previous step, set the DRIVE control fully clockwise, and connect the DC voltmeter to pin 7 of Q5004. Preset VR5002 fully counterclockwise, and then press the MOX button and rotate it slowly until the voltmeter drops to zero. Note the position of VR5002, and set it slightly counterclockwise from this point.

Now replace the 16.7-ohm dummy load with one 50-ohm load, press the MOX button and confirm that the tuner automatically starts and stops.

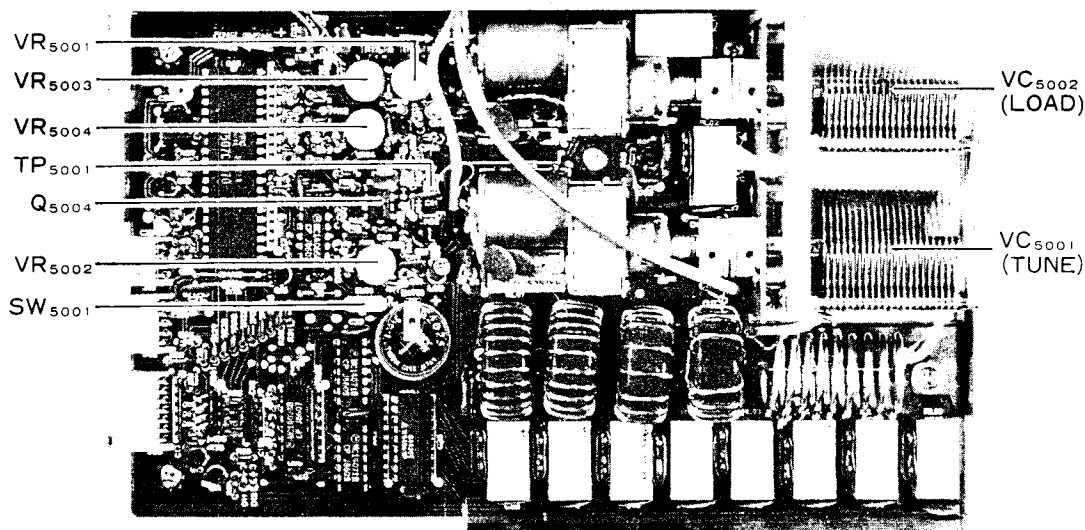

ANTENNA TUNER UNIT Alignment Points

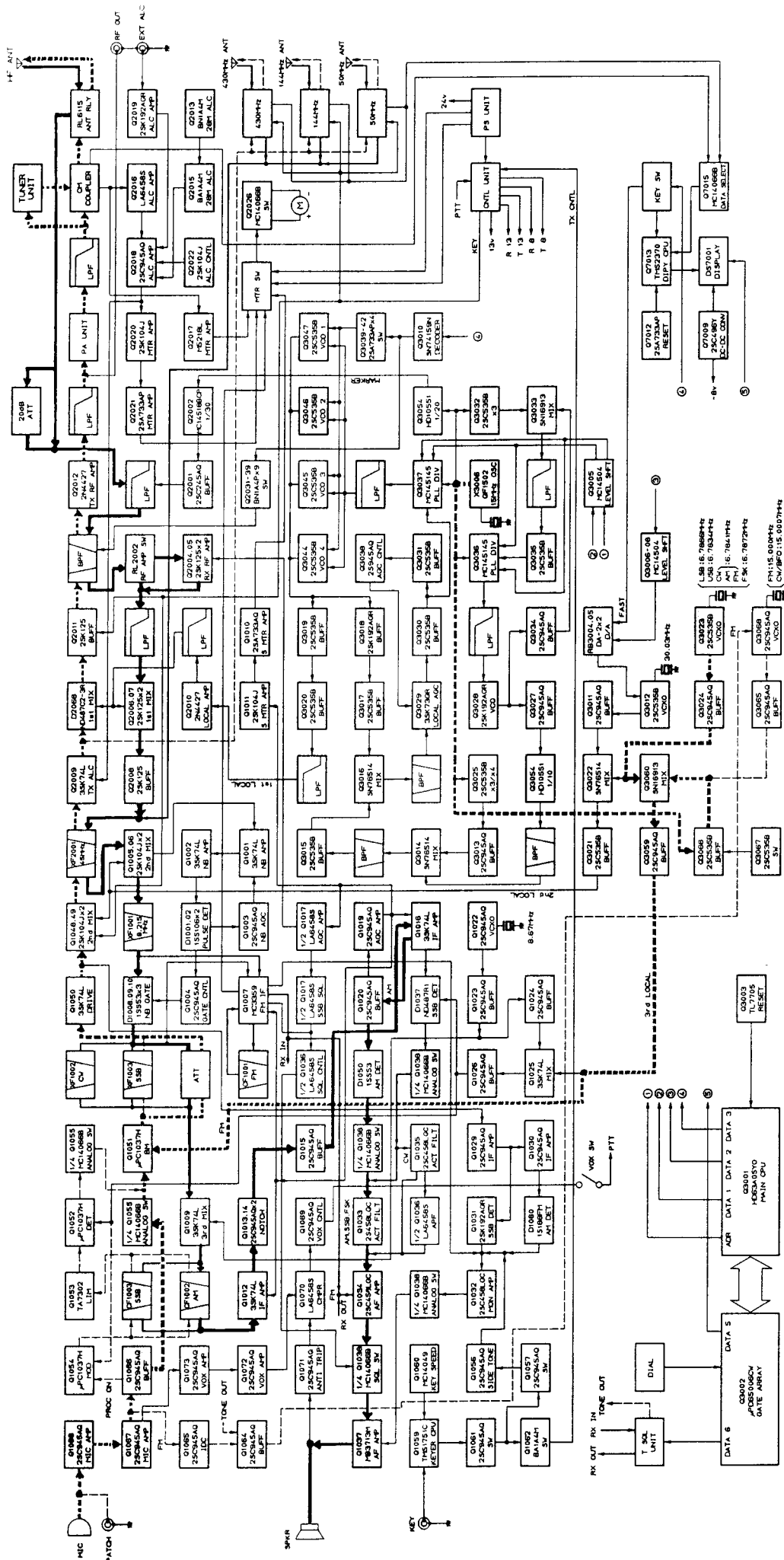

FT-767GX
BLOCK DIAGRAM

— RECEIVE
- - - TRANSMIT
— CONTROL

SIGNAL TRACING (AM MODE)

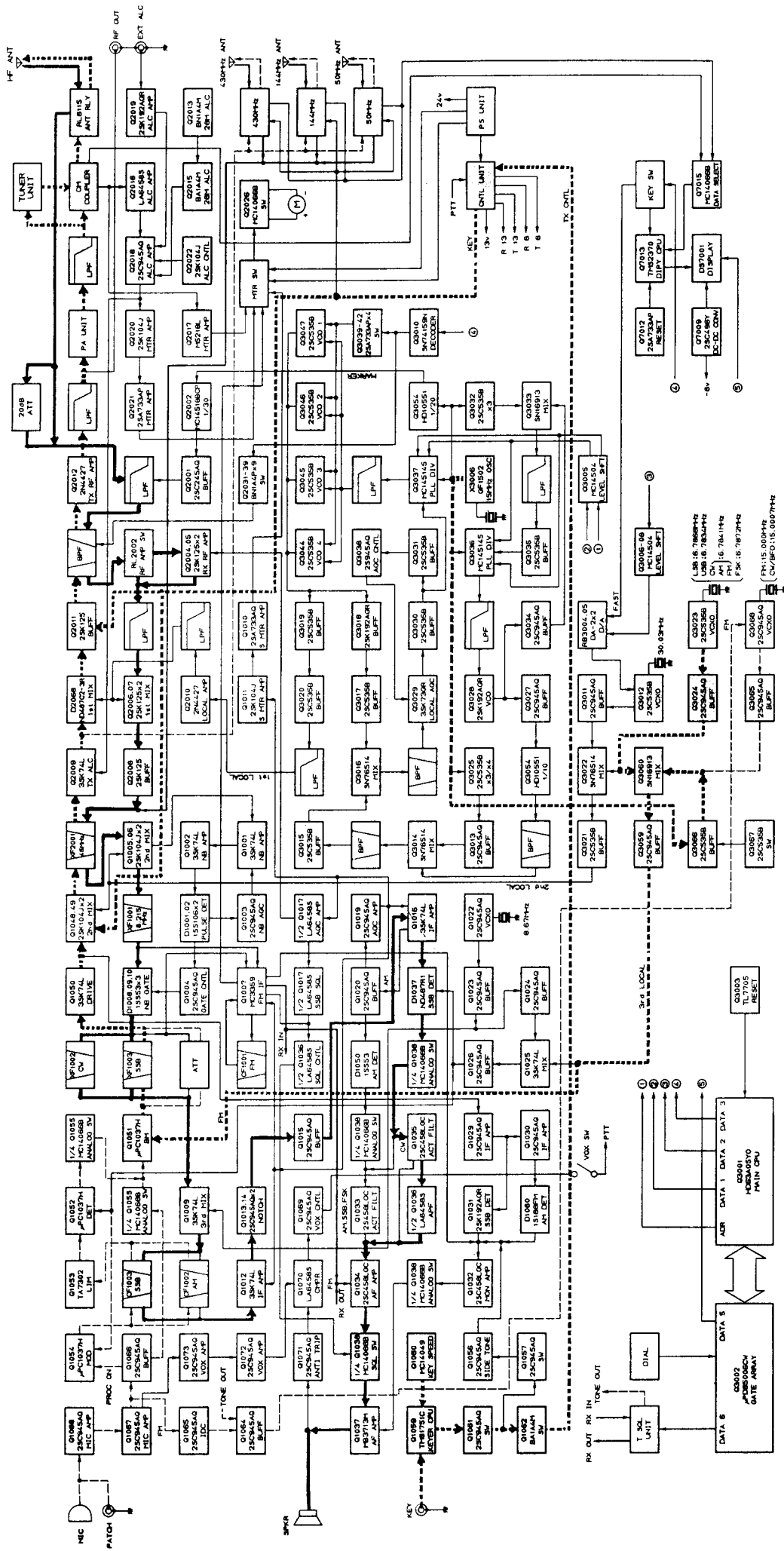

FT-767GX
BLOCK DIAGRAM

SIGNAL TRACING (CW MODE)

- RECEIVE
- - - TRANSMIT
- CONTROL

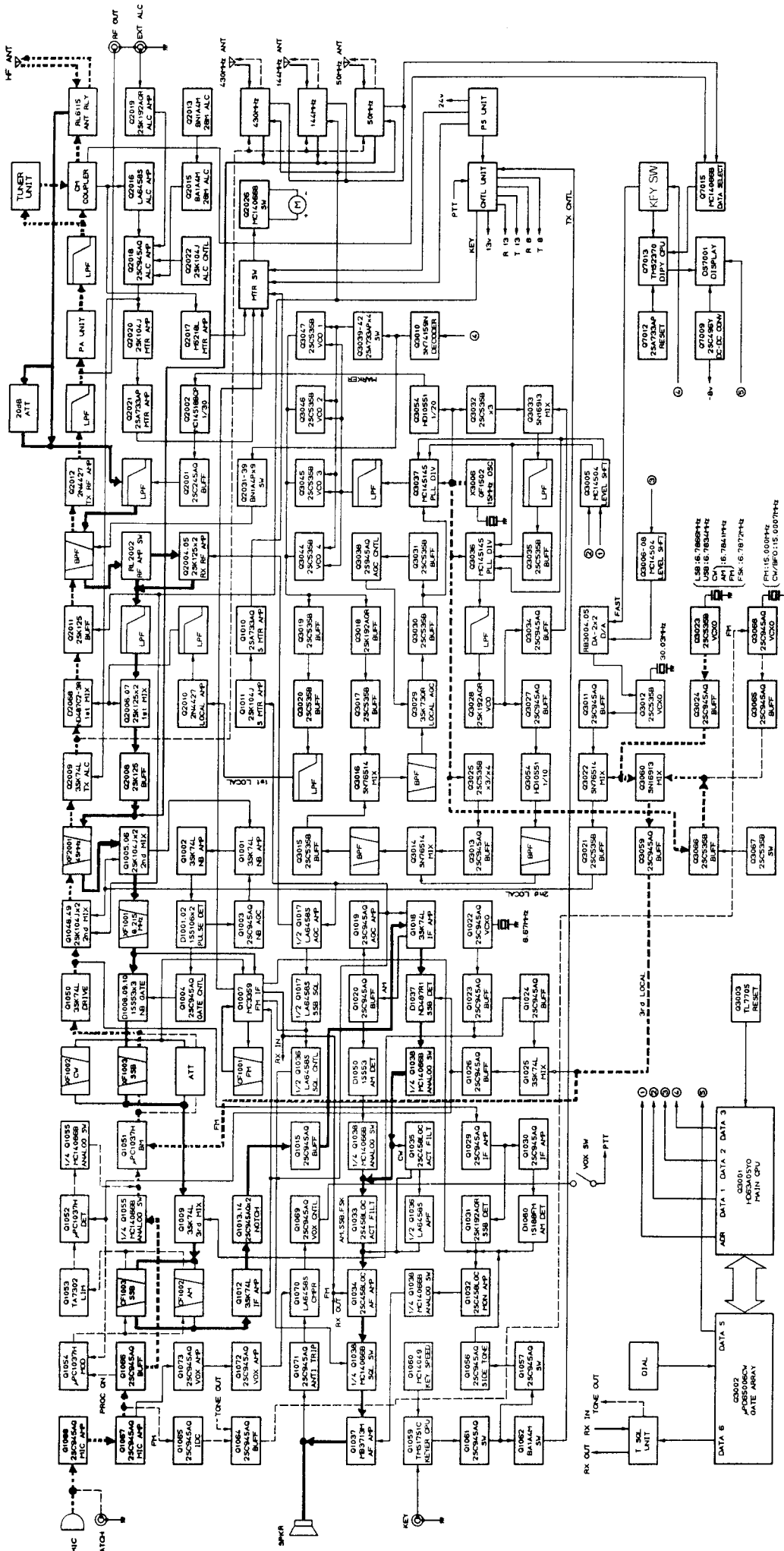

FT-767GX
BLOCK DIAGRAM

SIGNAL TRACING (SSB MODE)

- RECEIVE
- - - TRANSMIT
- · · CONTROL

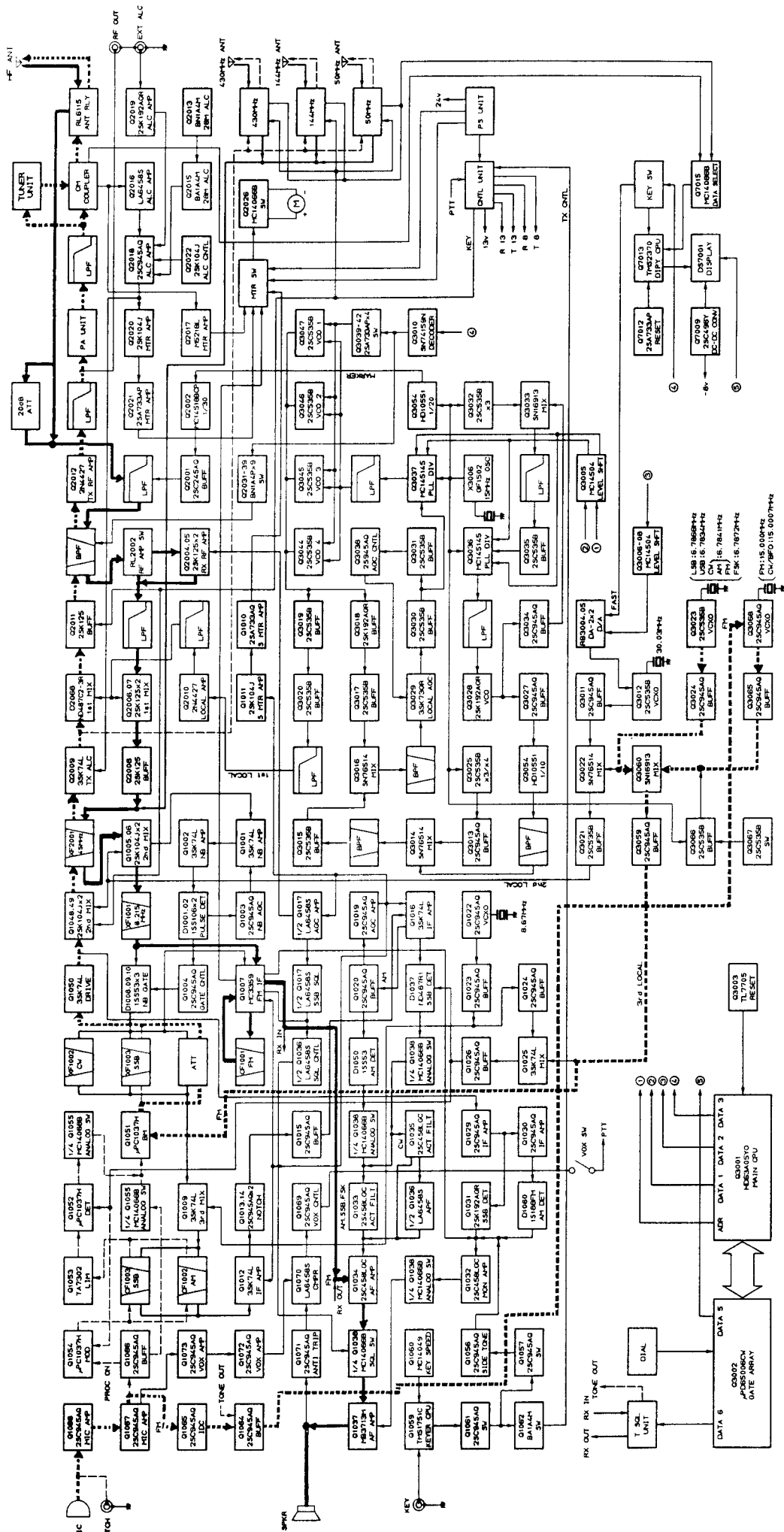

FT-767GX
BLOCK DIAGRAM

— RECEIVE
- - - TRANSMIT
... CONTROL

SIGNAL TRACING (FM MODE)

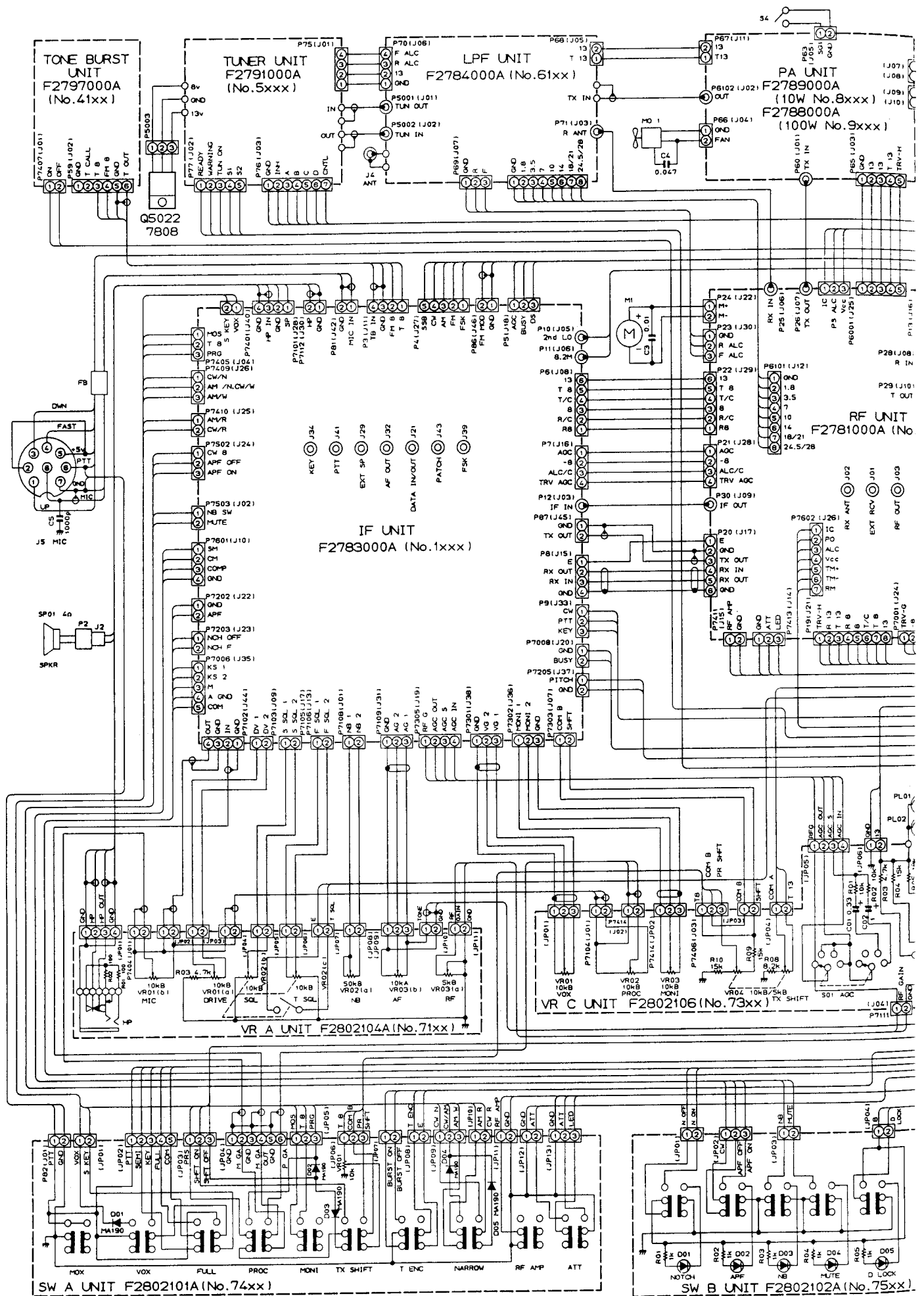

RESISTOR VALUES ARE IN Ω / μ / k : CAPACITOR VALUES ARE IN μ F:
 UNLESS OTHERWISE NOTED.
 (M) CAPACITORS ARE POLYESTER FILM.50 μ v.

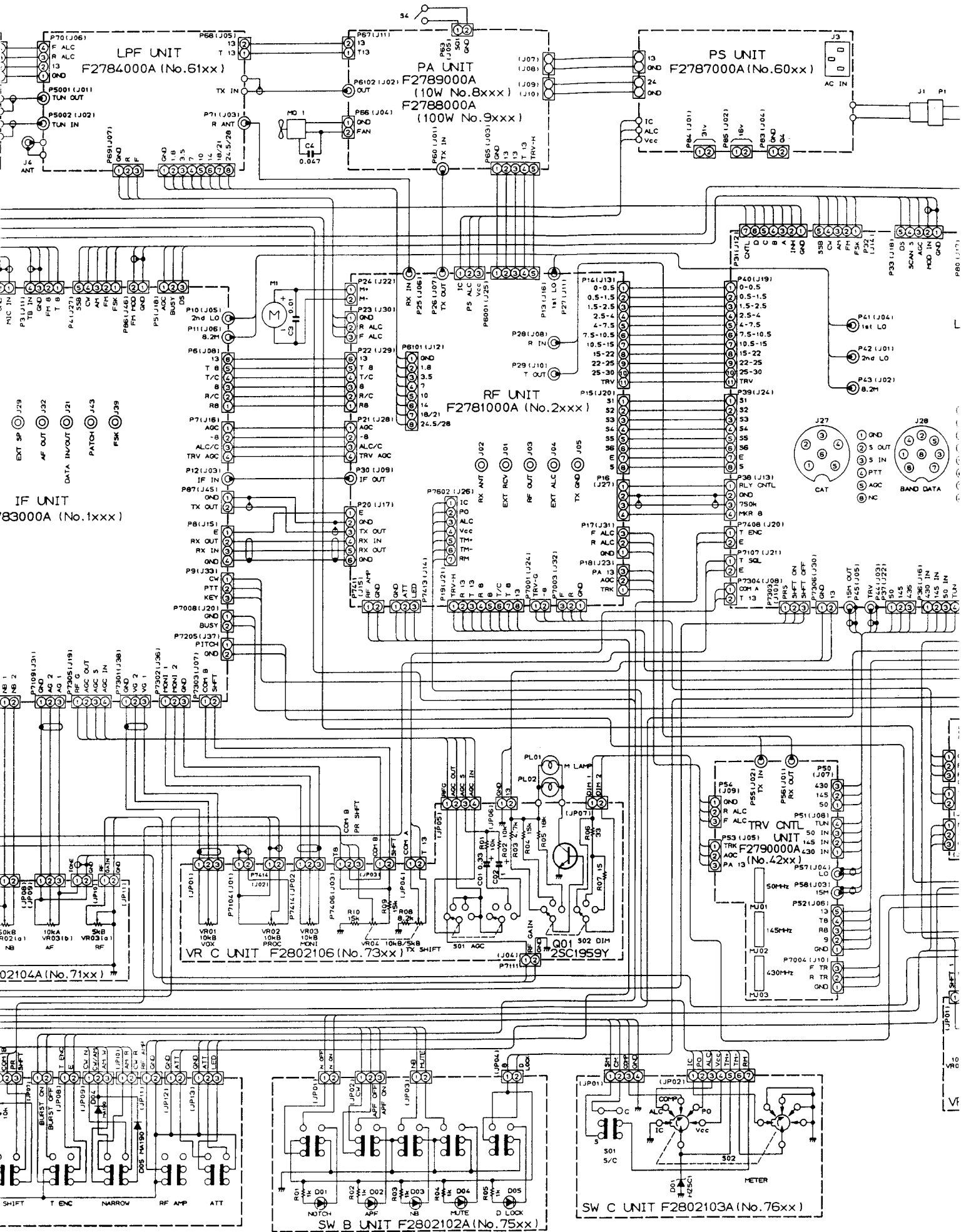

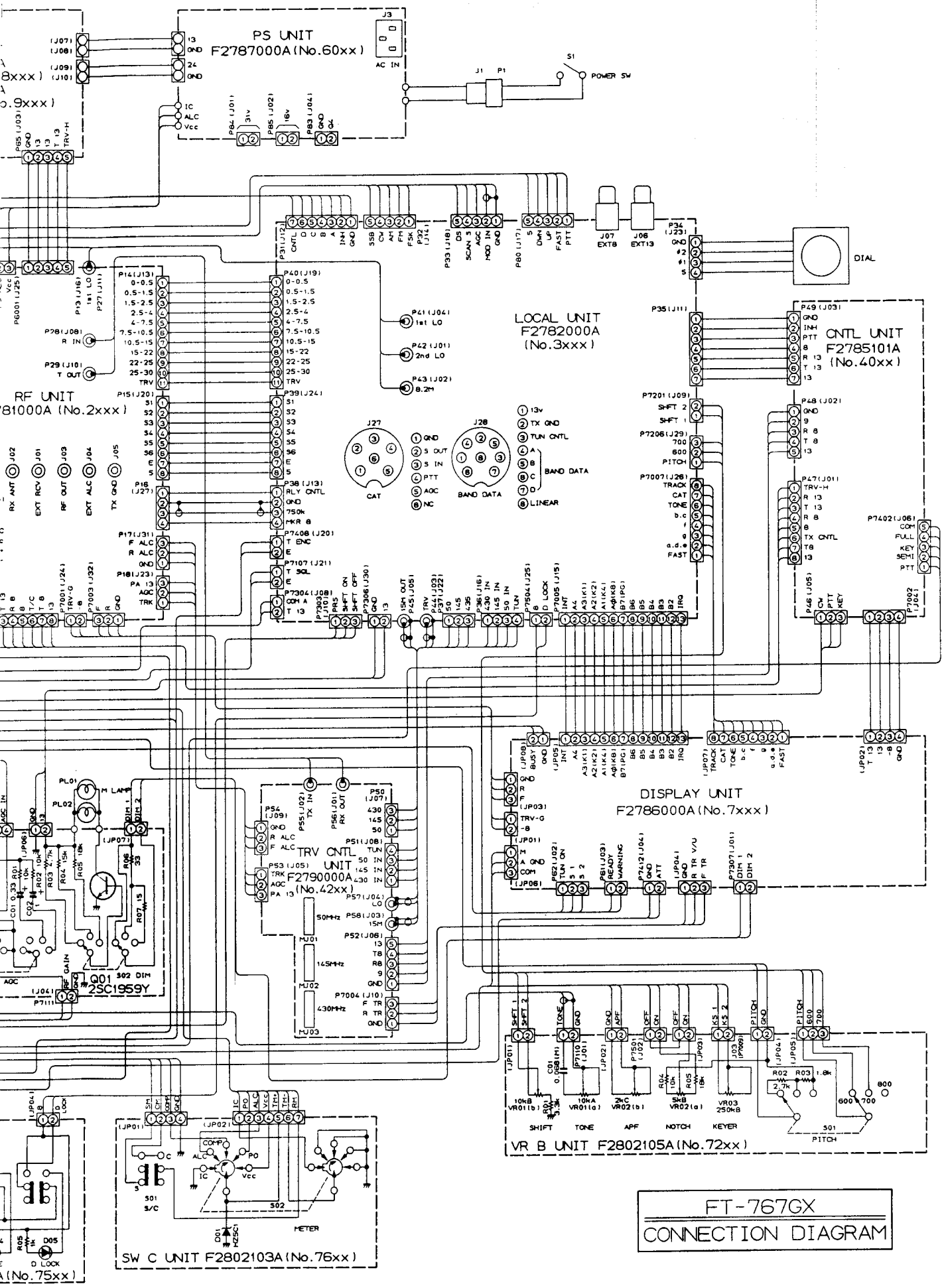

FT-767GX
CONNECTION DIAGRAM

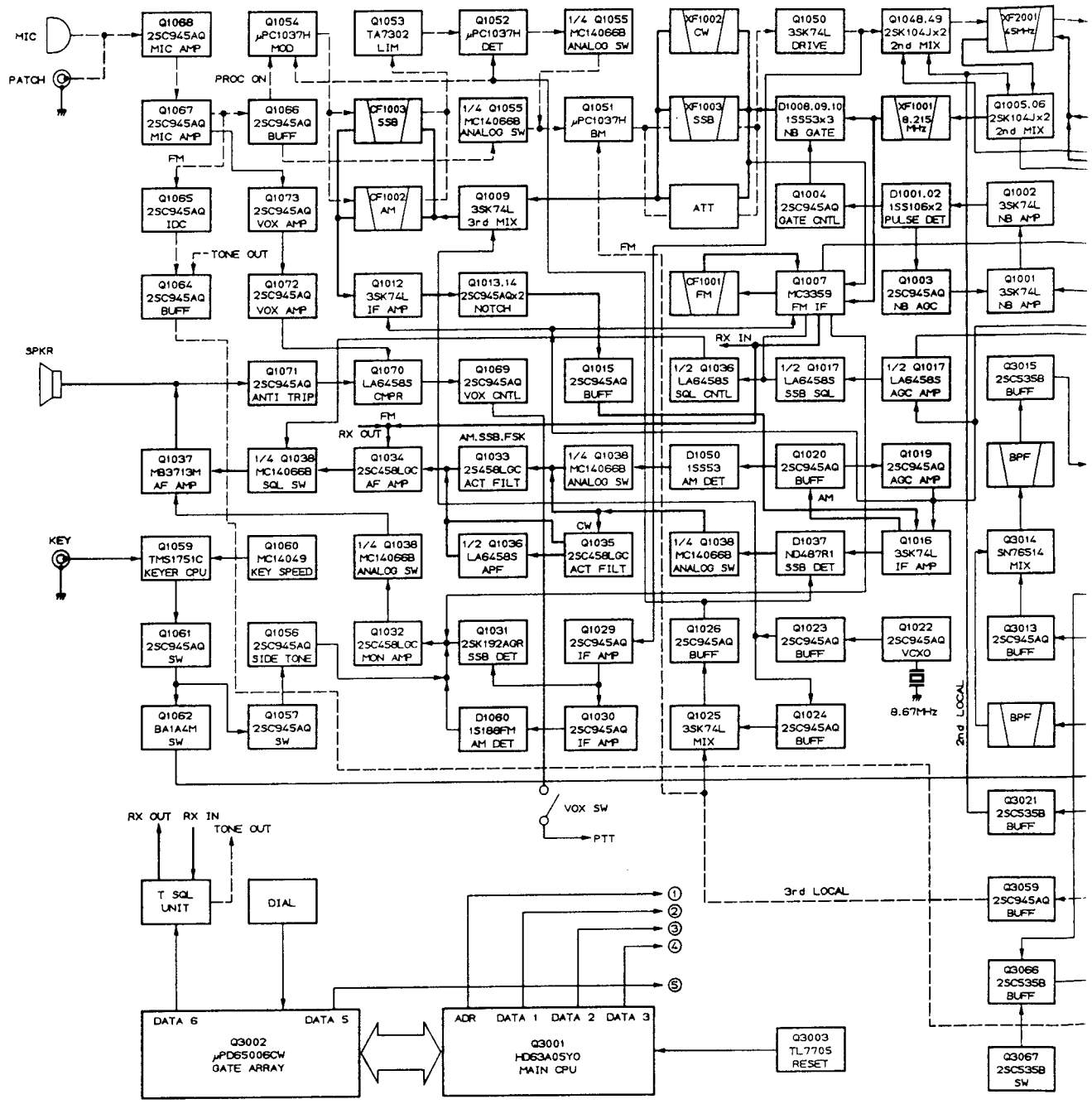

← REC
 ← TRA
 ← CON

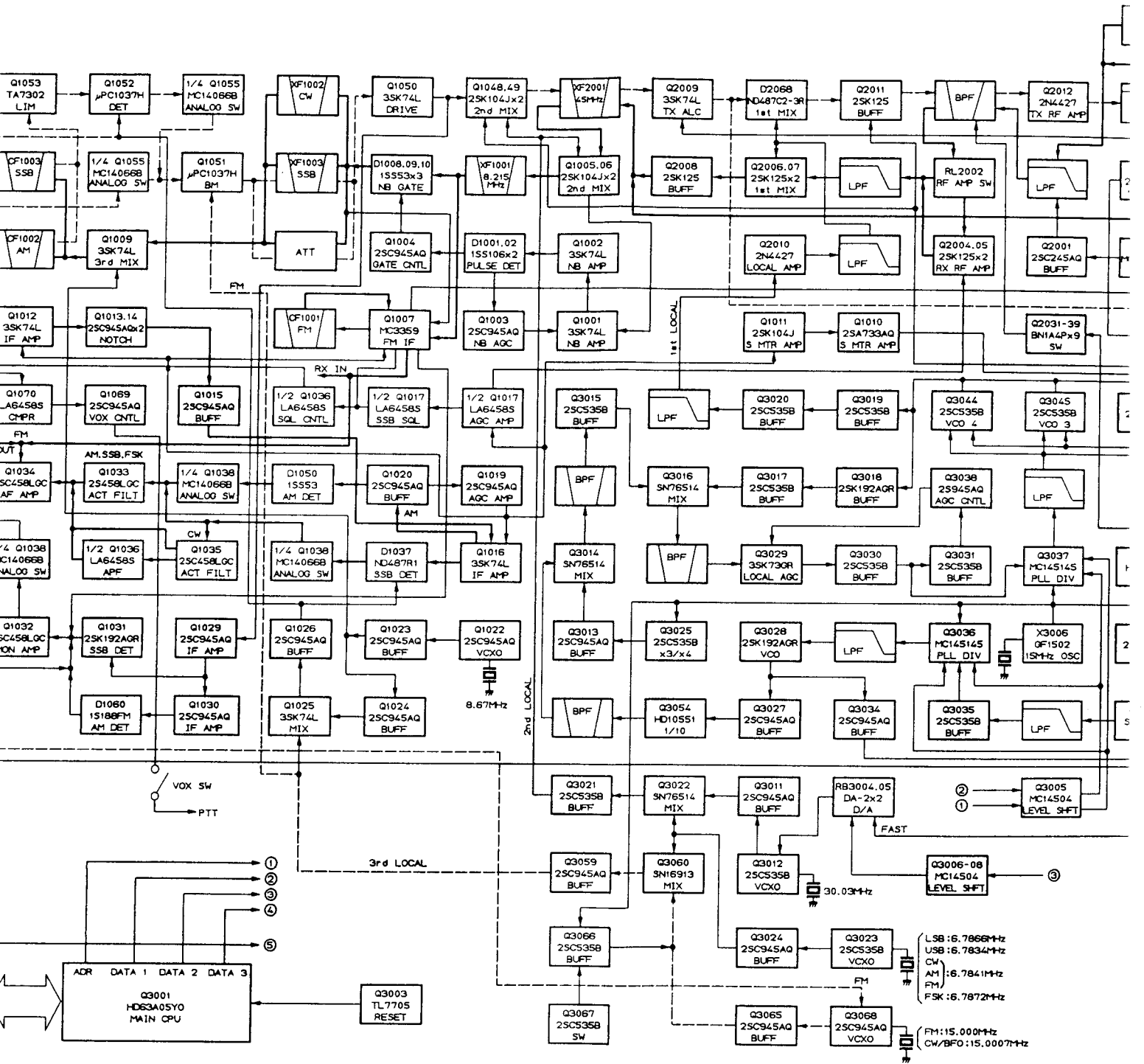

——— RECEIVE
 - - - TRANSMIT
 ····· CONTROL

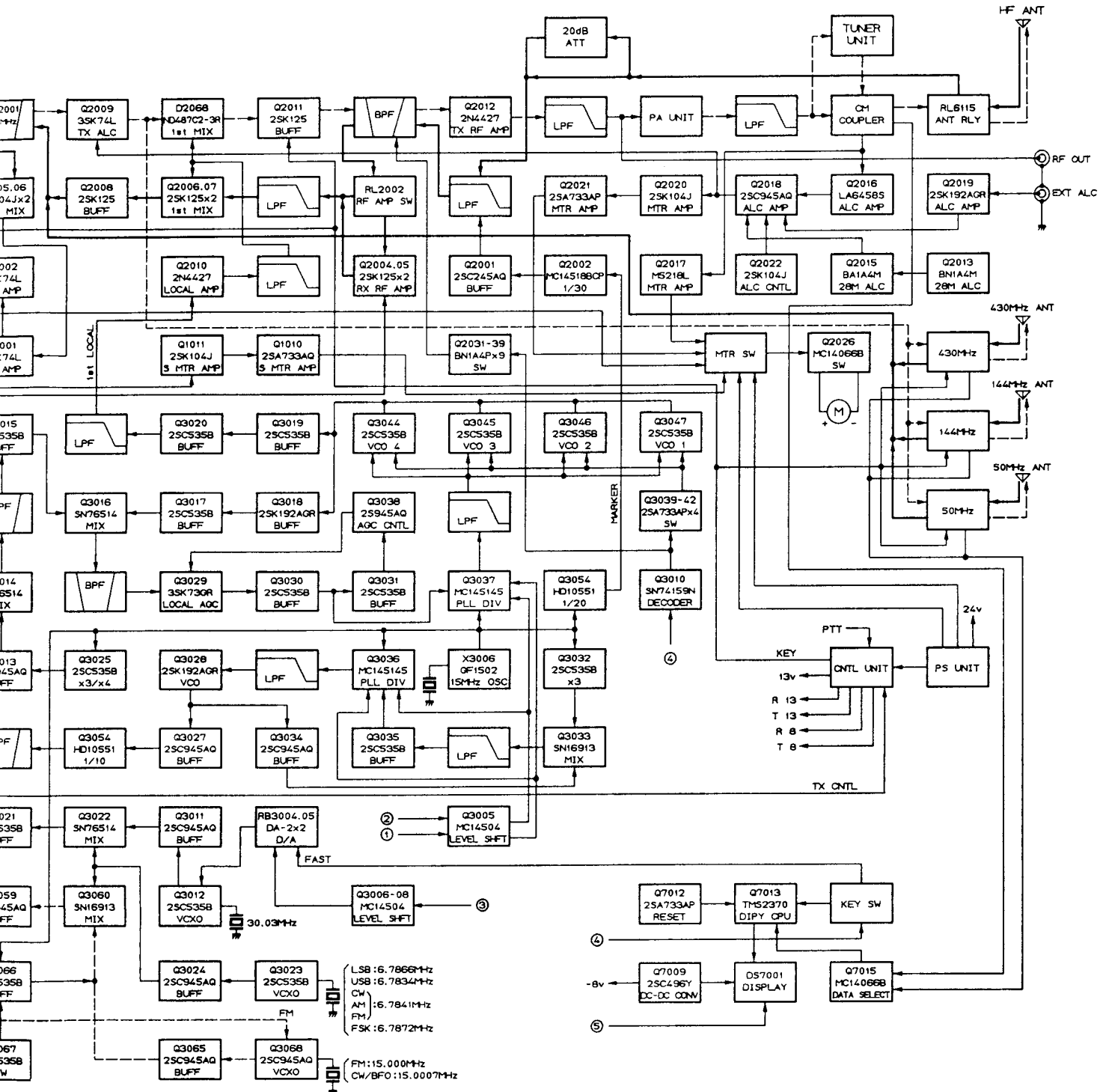

FT-767GX
BLOCK DIAGRAM

— RECEIVE
 — TRANSMIT
 — CONTROL

PS UNIT PARTS LAYOUT

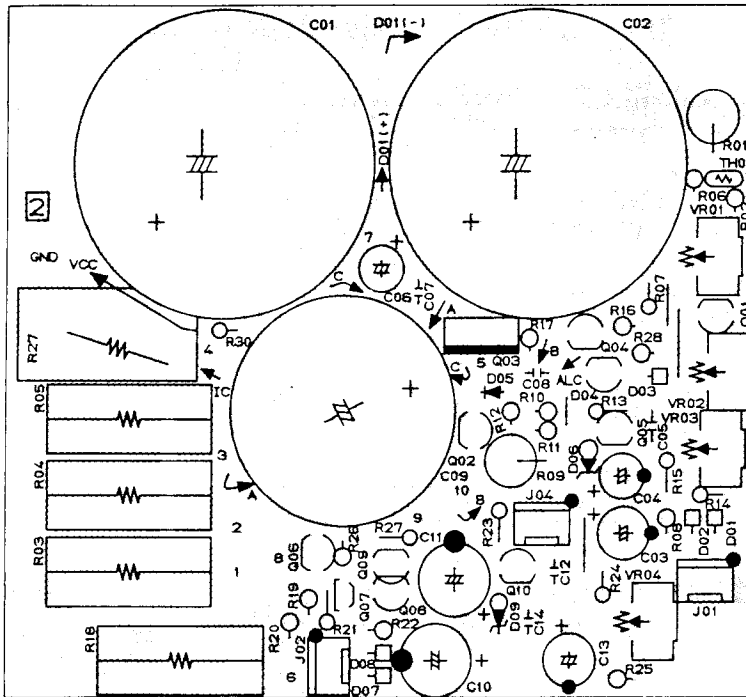

(Viewed from Component side)

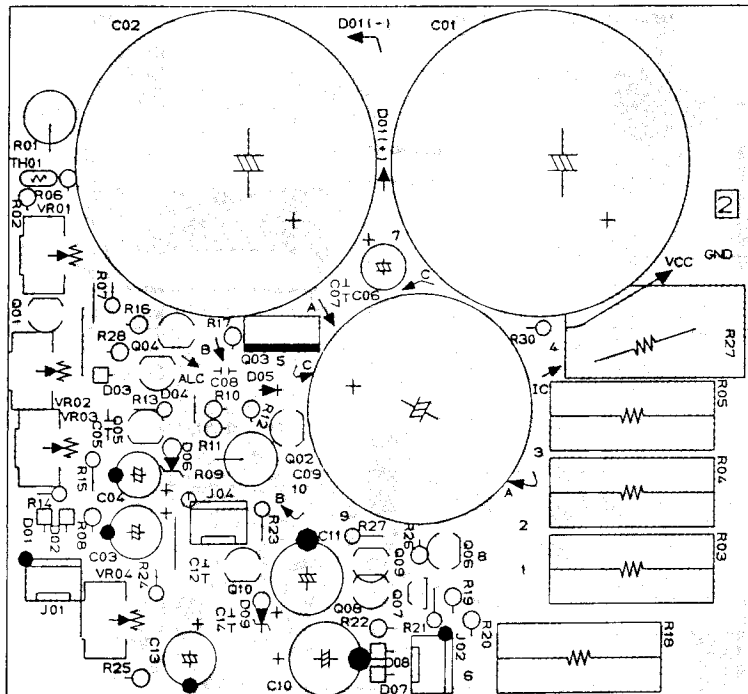

(Viewed from Solder side)

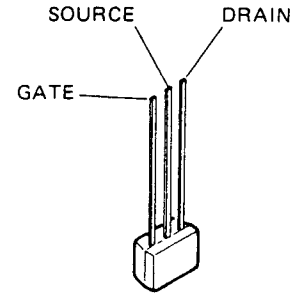

2SK192A-GR (Q6007)

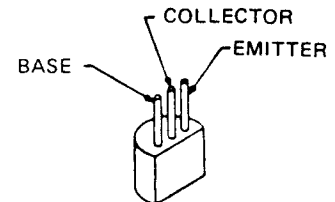

- 2SA684R (Q6005)
- 2SA733AP
- (Q6002,6004,6009)
- 2SA950Y (Q6008)
- 2SA1012Y (Q6003)
- 2SA1051Y (Q6010)
- 2SC458B (Q6001,6006)

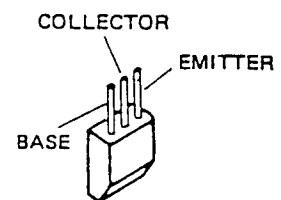

2SD717Y (Q6011-6014)

PS UNIT VOLTAGE CHART (DC VOLTS)

	E	(S)	C	(D)	B	(G ₁)
	R	T	R	T	R	T
Q6001	-18.4	—	13.3	—	-18.3	—
Q6002	23.5	—	- 4.8	—	23.5	—
Q6003	0	—	-17.0	—	- 0.5	—
Q6004	13.4	—	0	—	13.3	—
Q6005	17.1	—	- 0.5	—	16.6	—
Q6006	- 6.5	—	0	—	- 6.3	—
Q6007	- 6.6	—	- 0.6	—	- 6.6	—
Q6008	0	—	- 5.7	—	- 0.6	—
Q6009	0	—	- 0.6	—	0	—
Q6010	7.2	—	- 0.6	—	6.6	—
Q1	-17.7	—	0	—	-17.0	—
Q2	-17.7	—	0	—	-17.0	—
Q3	-17.7	—	0	—	-17.0	—
Q4	- 6.3	—	0	—	- 5.7	—

PS UNIT CIRCUIT DIAGRAM

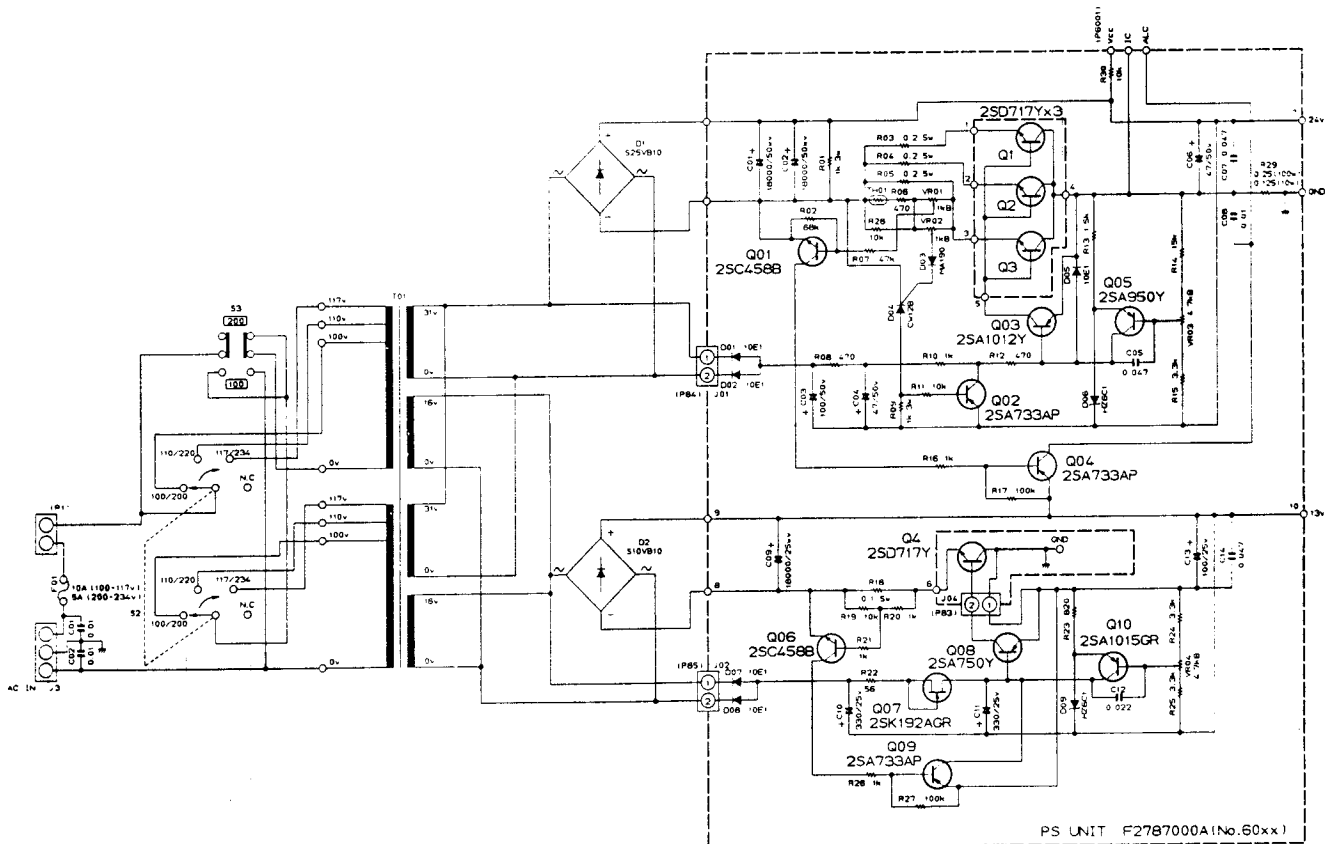

RESISTOR VALUES ARE IN OHMS; CAPACITOR VALUES ARE IN μ F;
UNLESS OTHERWISE NOTED

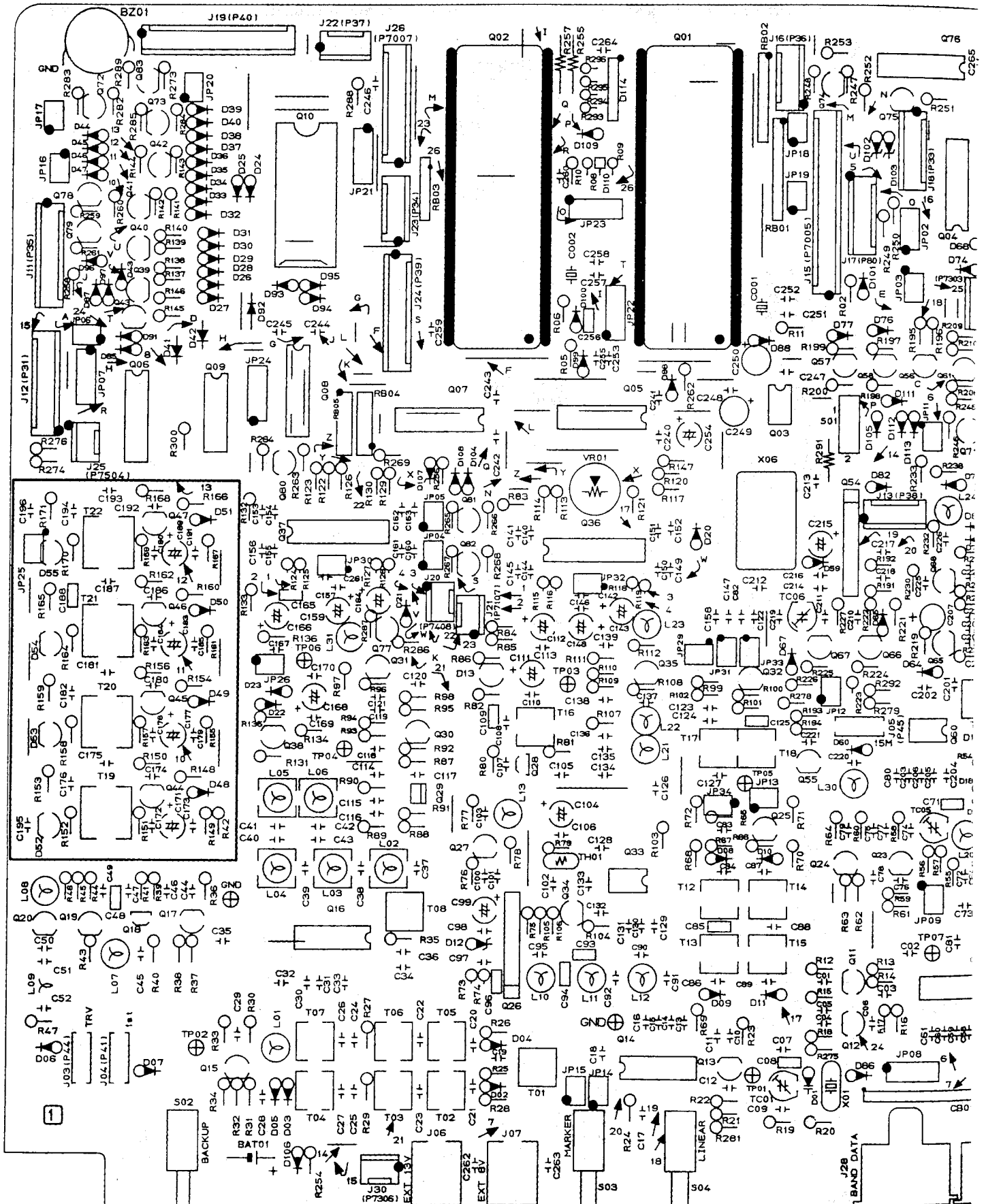

(Viewed from Com

LOCAL UNIT PARTS LAYOUT

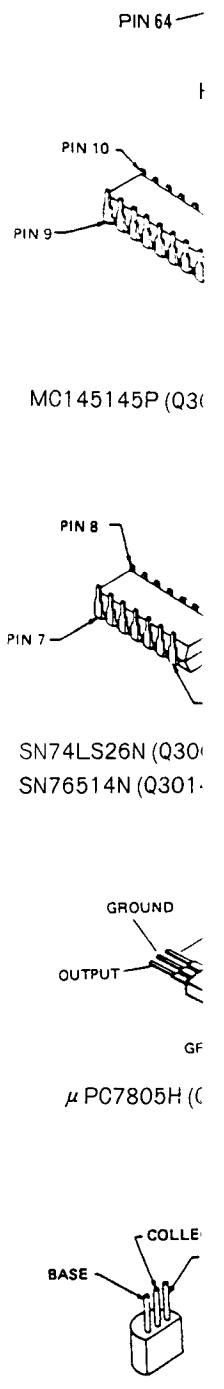
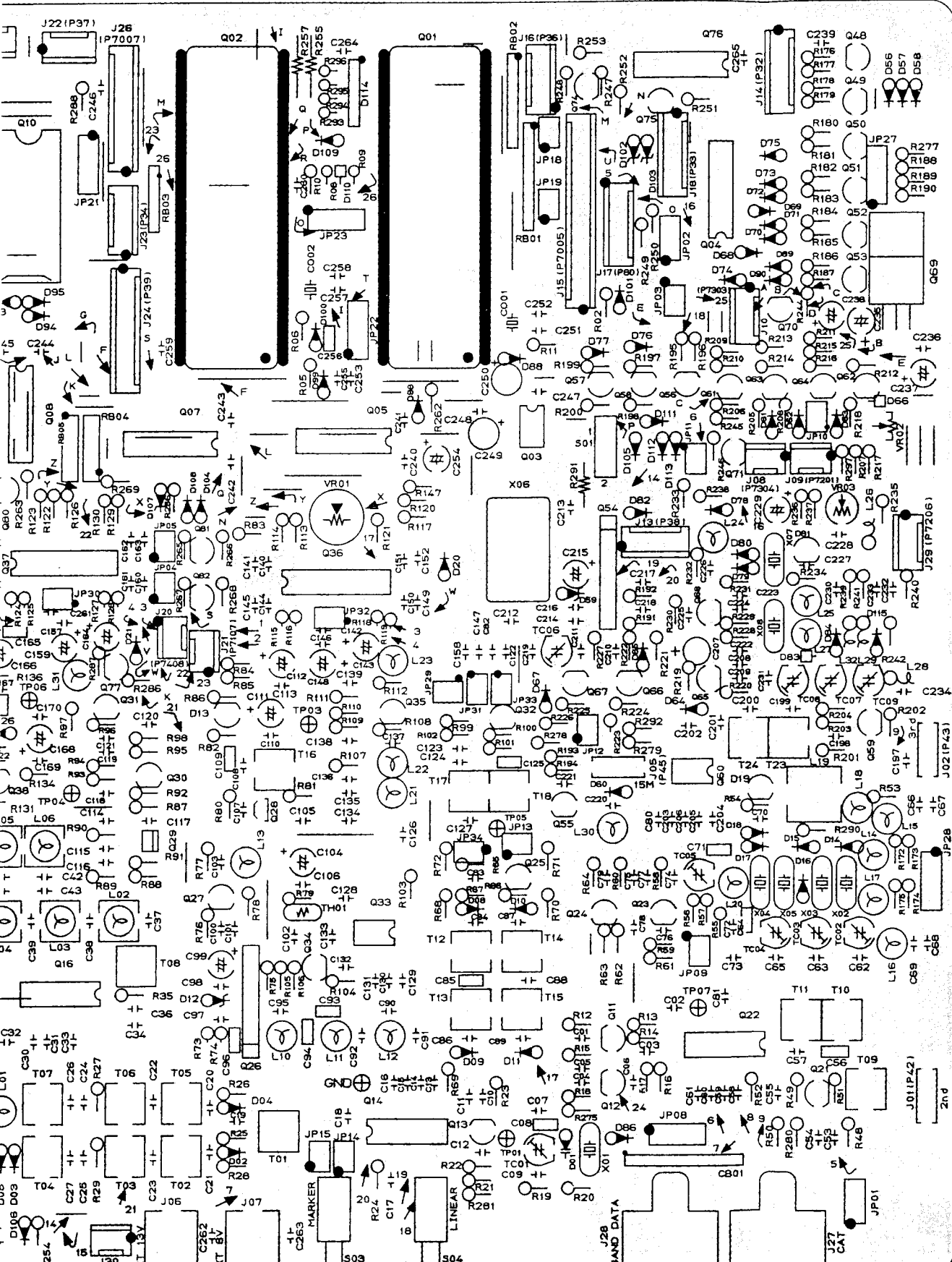

(Viewed from Component side)

PARTS LAYOUT

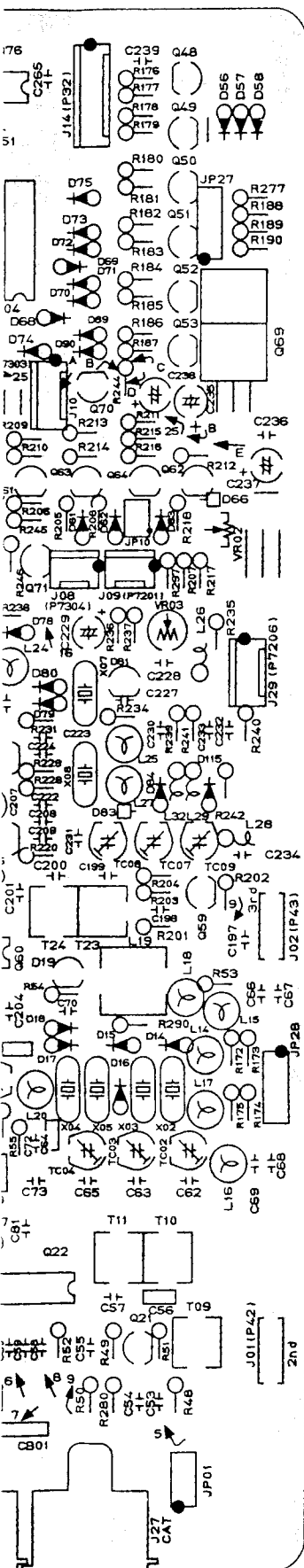

Component side)

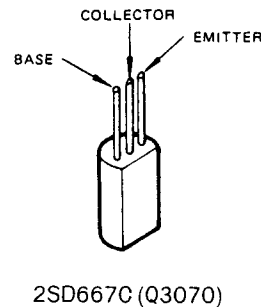
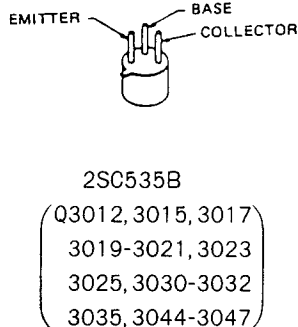
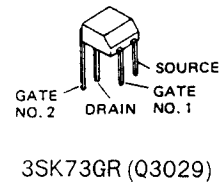
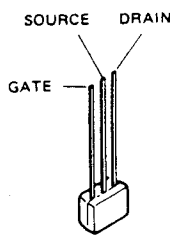
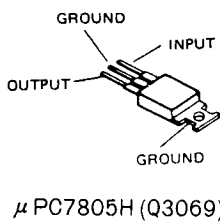
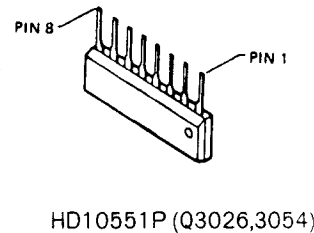
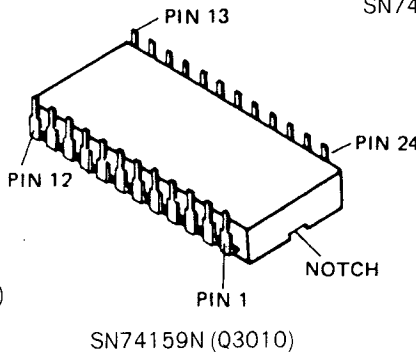
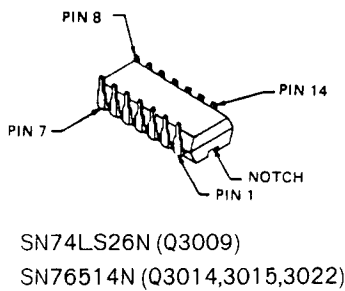
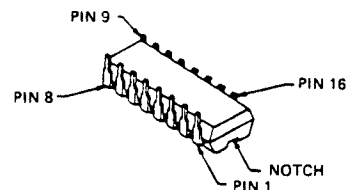
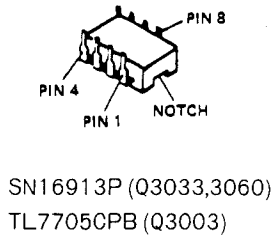
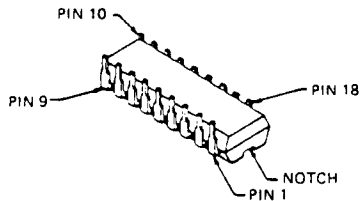
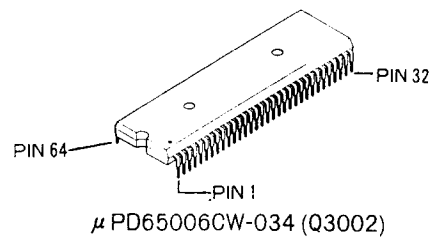
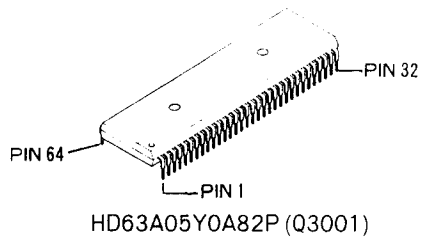

LOCAL UNIT PARTS LAYOUT

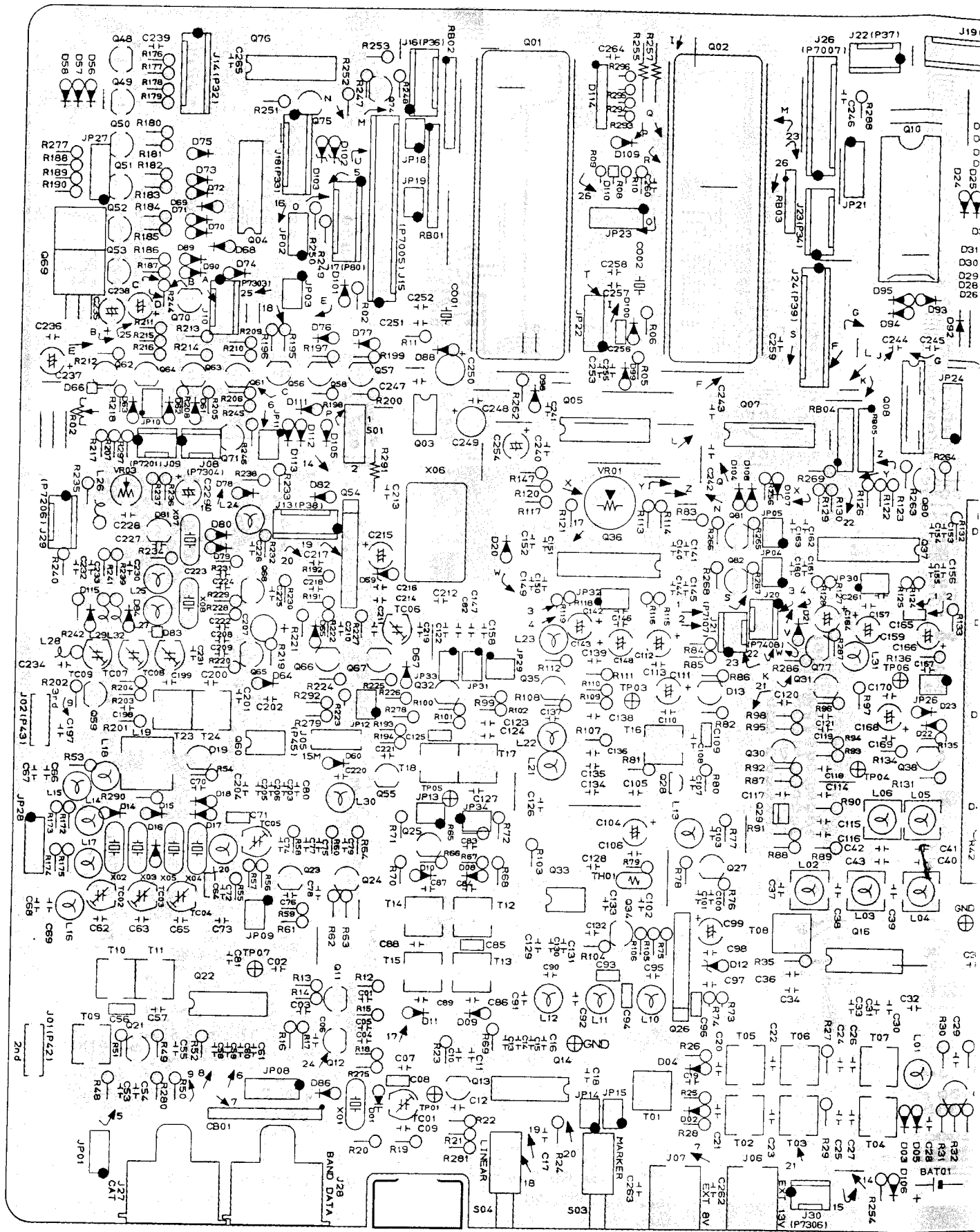

(Viewed from

LOCAL UNIT PARTS LAYOUT

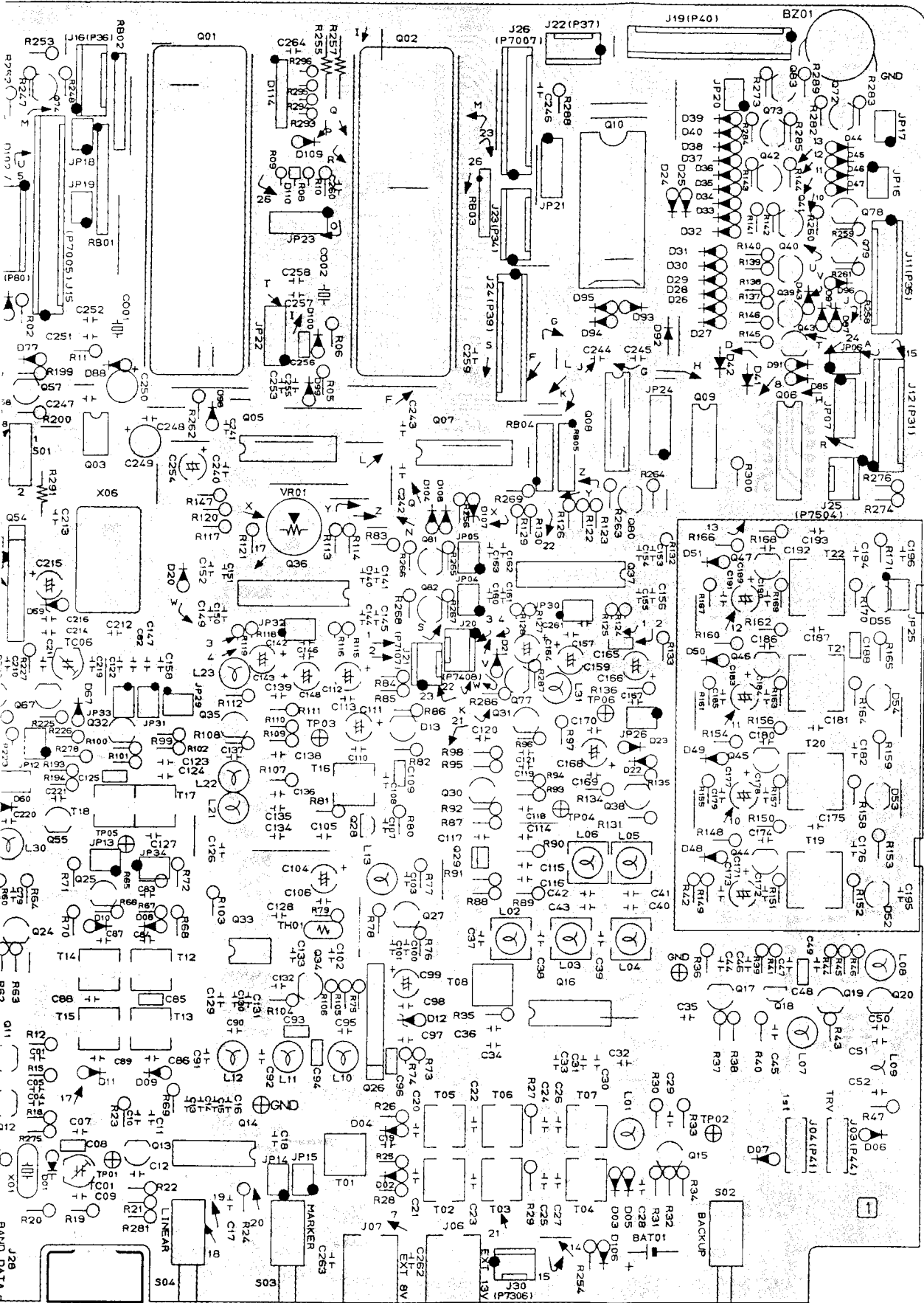

(Viewed from Solder side)

Q3011
Q3012
Q3013
Q3015
Q3017
Q3018
Q3019
Q3020
Q3021
Q3023
Q3024
Q3025
Q3027
Q3028
Q3029
Q3030
Q3031
Q3032
Q3034
Q3035
Q3038
Q3039
Q3040
Q3041
Q3042
Q3043
Q3044
Q3045
Q3046
Q3047
Q3048
Q3049
Q3050
Q3051
Q3052
Q3053
Q3055
Q3056
Q3057
Q3058
Q3059
Q3061
Q3062
Q3063
Q3064
Q3065
Q3066
Q3067
Q3068
Q3069
Q3070
Q3071
Q3072
Q3073
Q3074
Q3075
Q3077
Q3078
Q3079
Q3080
Q3081
Q3082
Q3083

PIN No.	1
Q3003	-
Q3004	-
Q3005	5.0
Q3006	5.0
Q3007	5.0
Q3008	5.0
Q3009	-
Q3014	-
Q3016	8
Q3022	8
Q3026	-
Q3033	-
Q3036	-
Q3037	-
Q3054	-
Q3060	-
Q3076	5.0

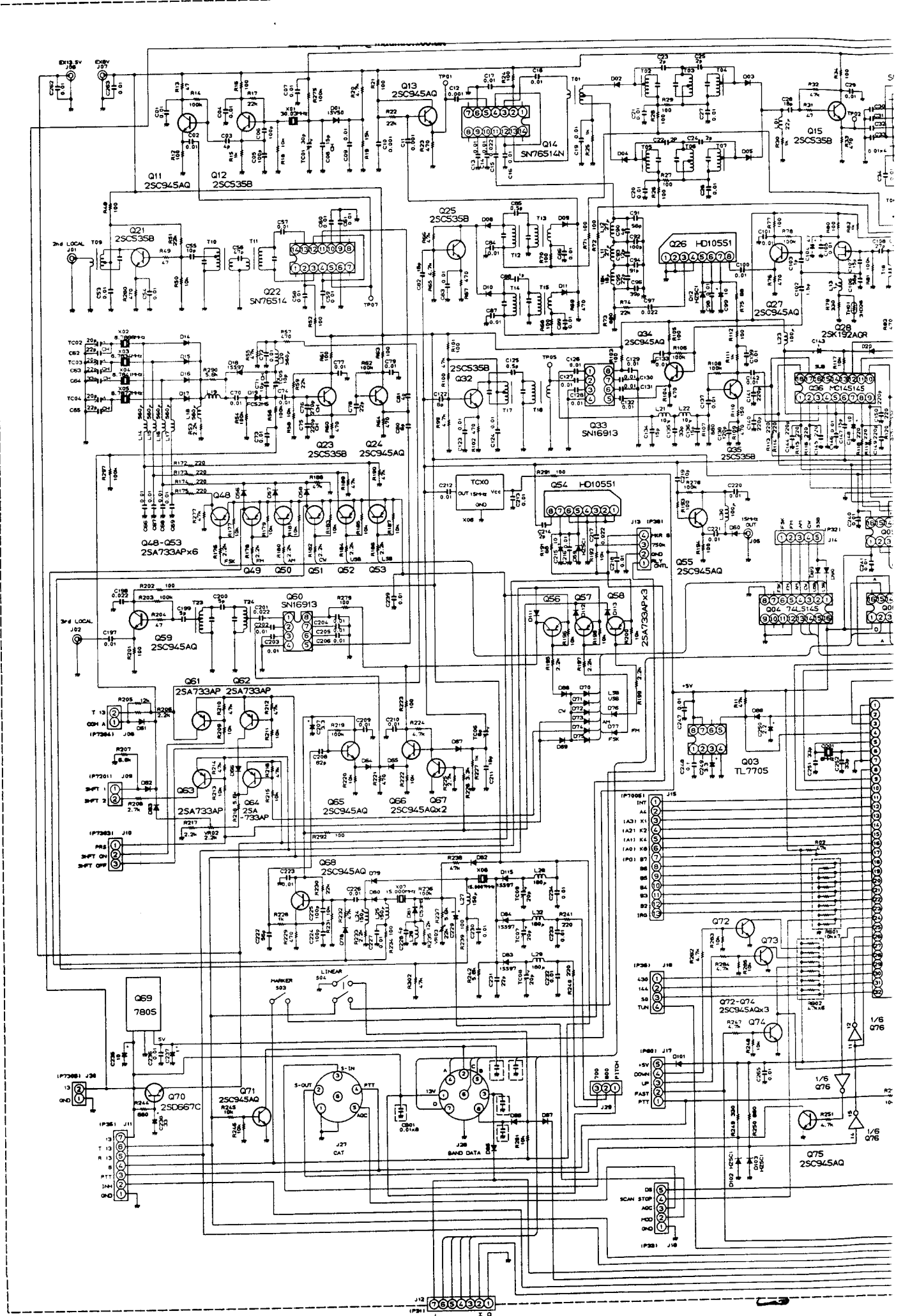

LOCAL UNIT CIRCUIT DIAGRAM

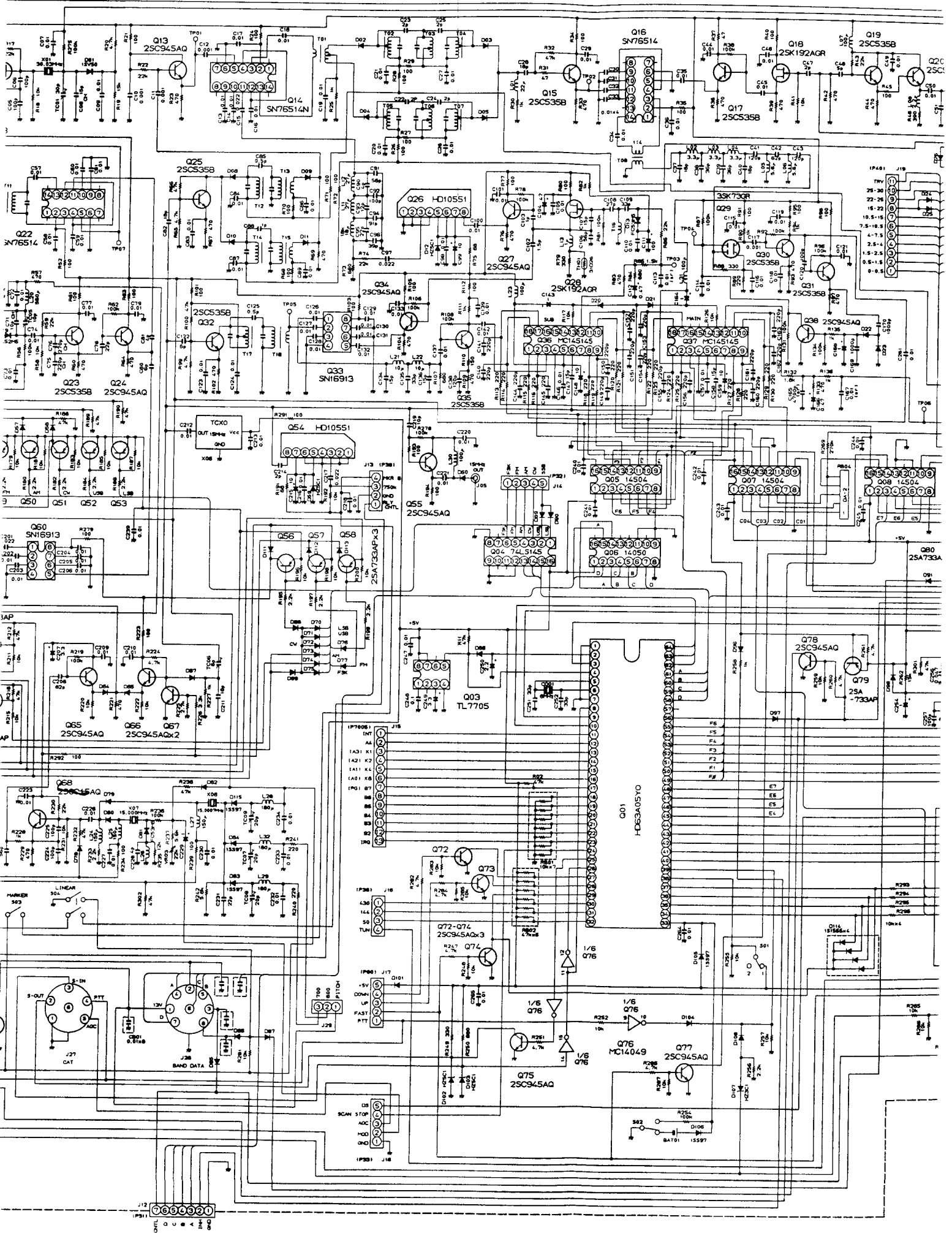

UNIT CIRCUIT DIAGRAM

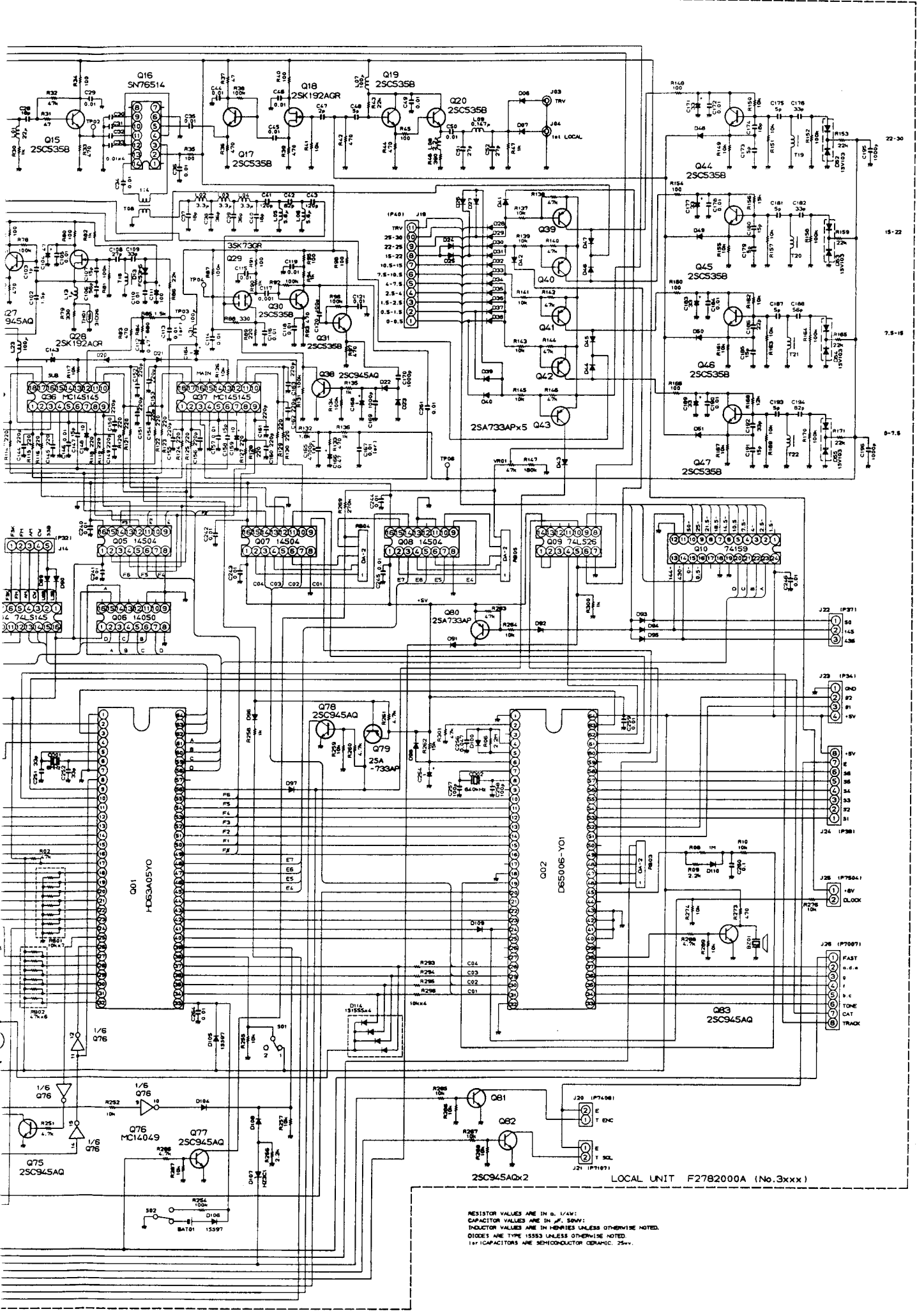

RESISTOR VALUES ARE IN Ω, 1/4W;
 CAPACITOR VALUES ARE IN μF, 50V;
 INDUCTOR VALUES ARE IN HENRIES UNLESS OTHERWISE NOTED.
 DIODES ARE TYPE 1S583 UNLESS OTHERWISE NOTED.
 1. CAPACITORS ARE SEMICONDUCTOR CERAMIC, 25V.

LPF UNIT PARTS LAYOUT

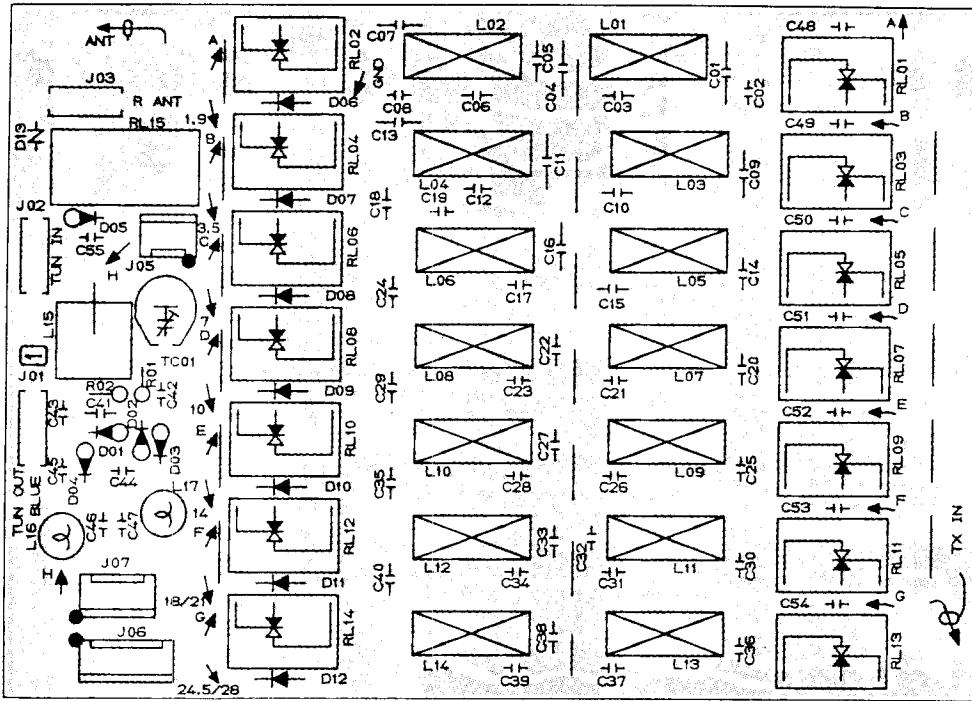

(Viewed from Component side)

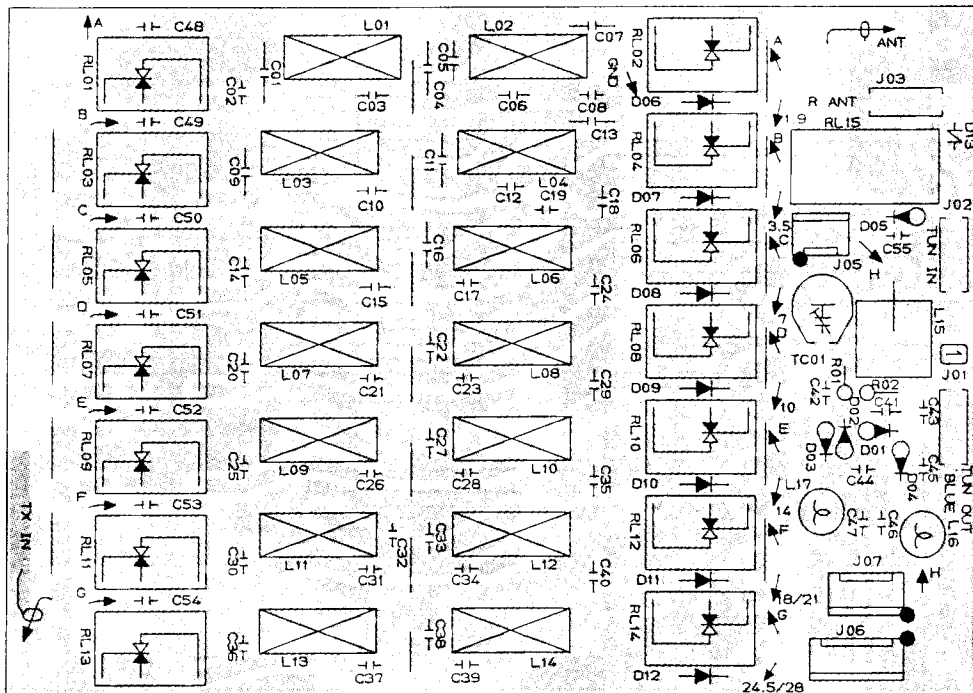

(Viewed from Solder side)

LPF UNIT CIRCUIT DIAGRAM

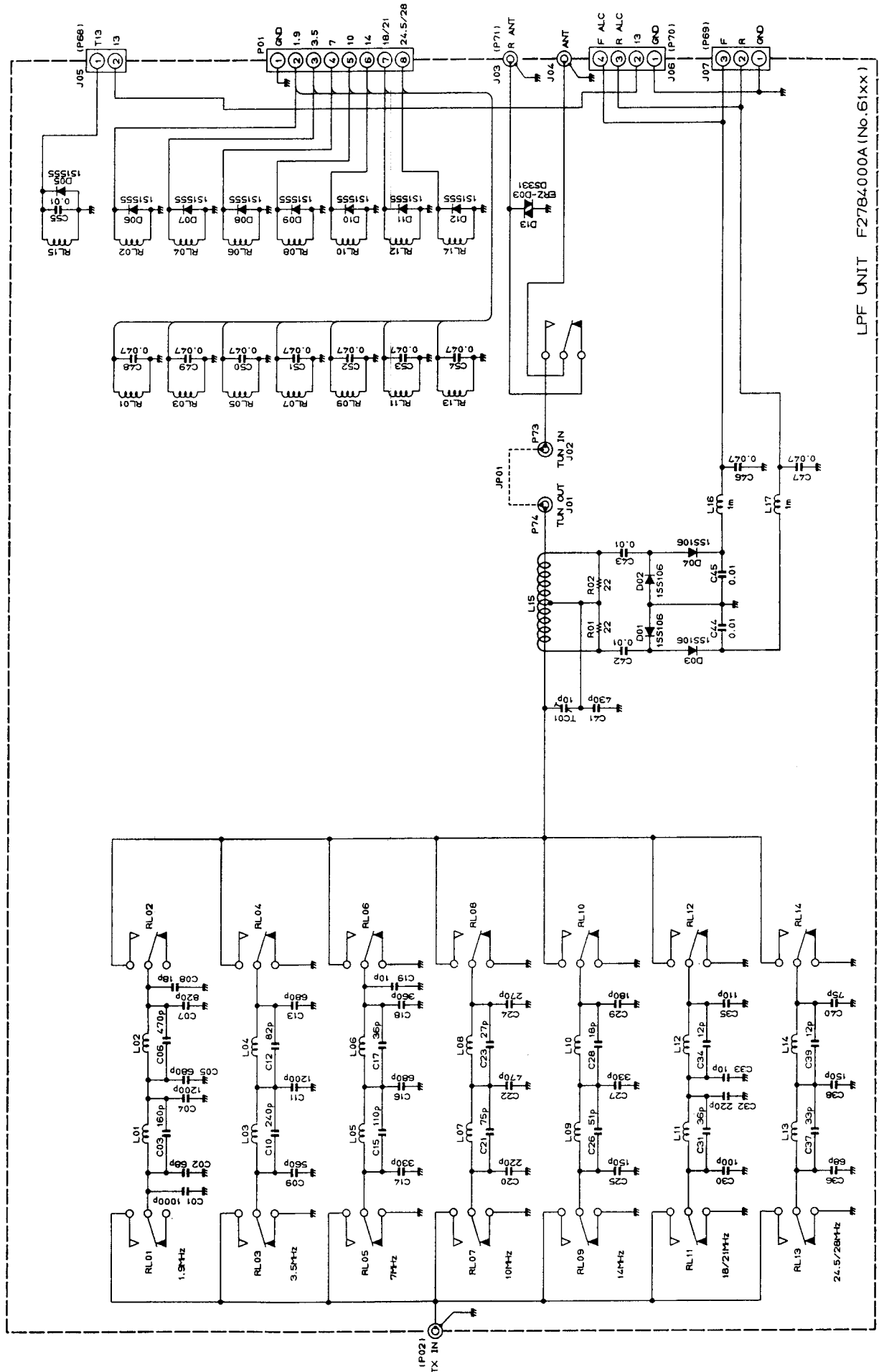

RESISTOR VALUES ARE IN Ω , μ , k , M ; CAPACITOR VALUES ARE IN μ F, n F, p F; AND INDUCTOR VALUES ARE IN H; UNLESS OTHERWISE NOTED.

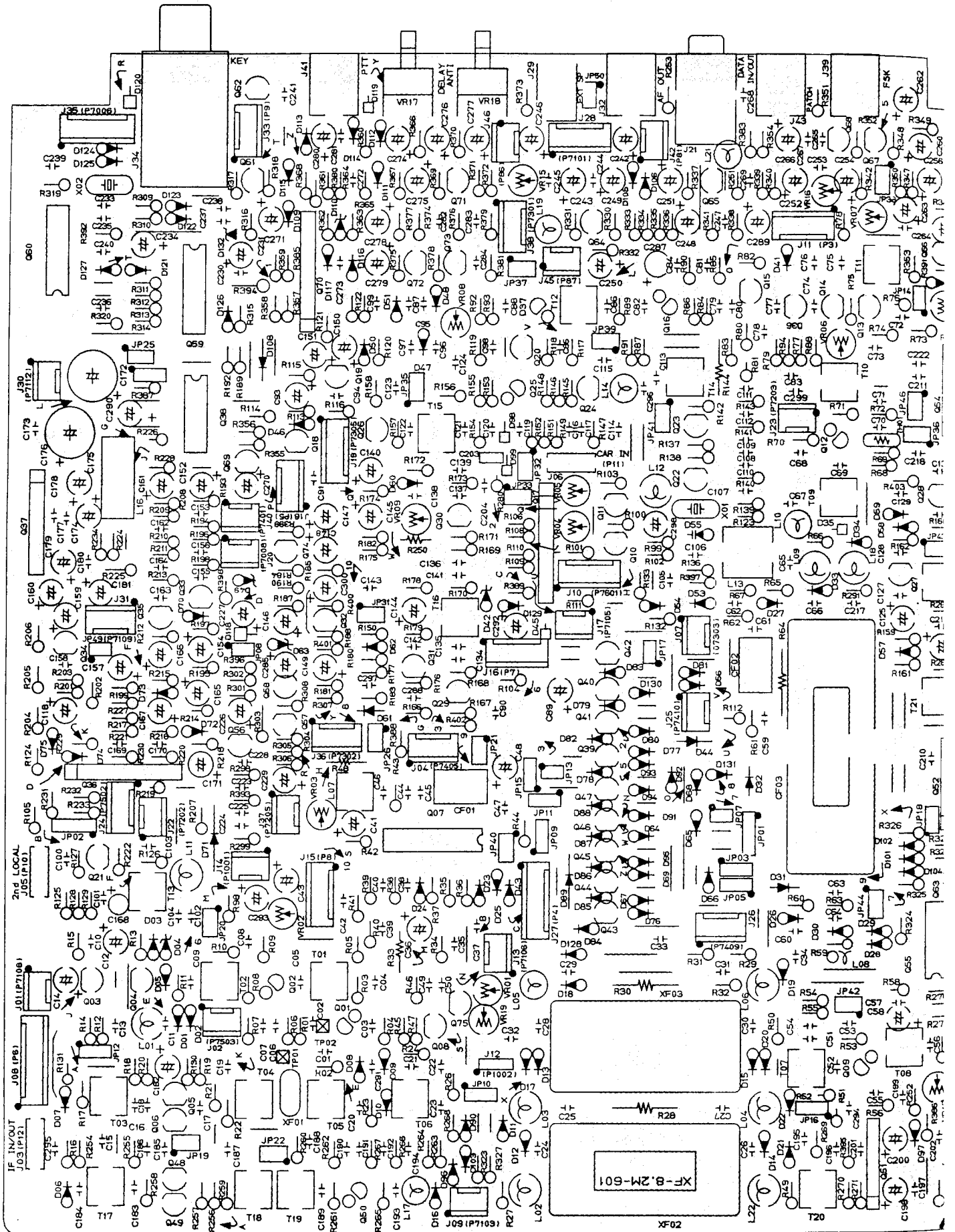

(Viewed from Component side)

IF UNIT PARTS LAYOUT

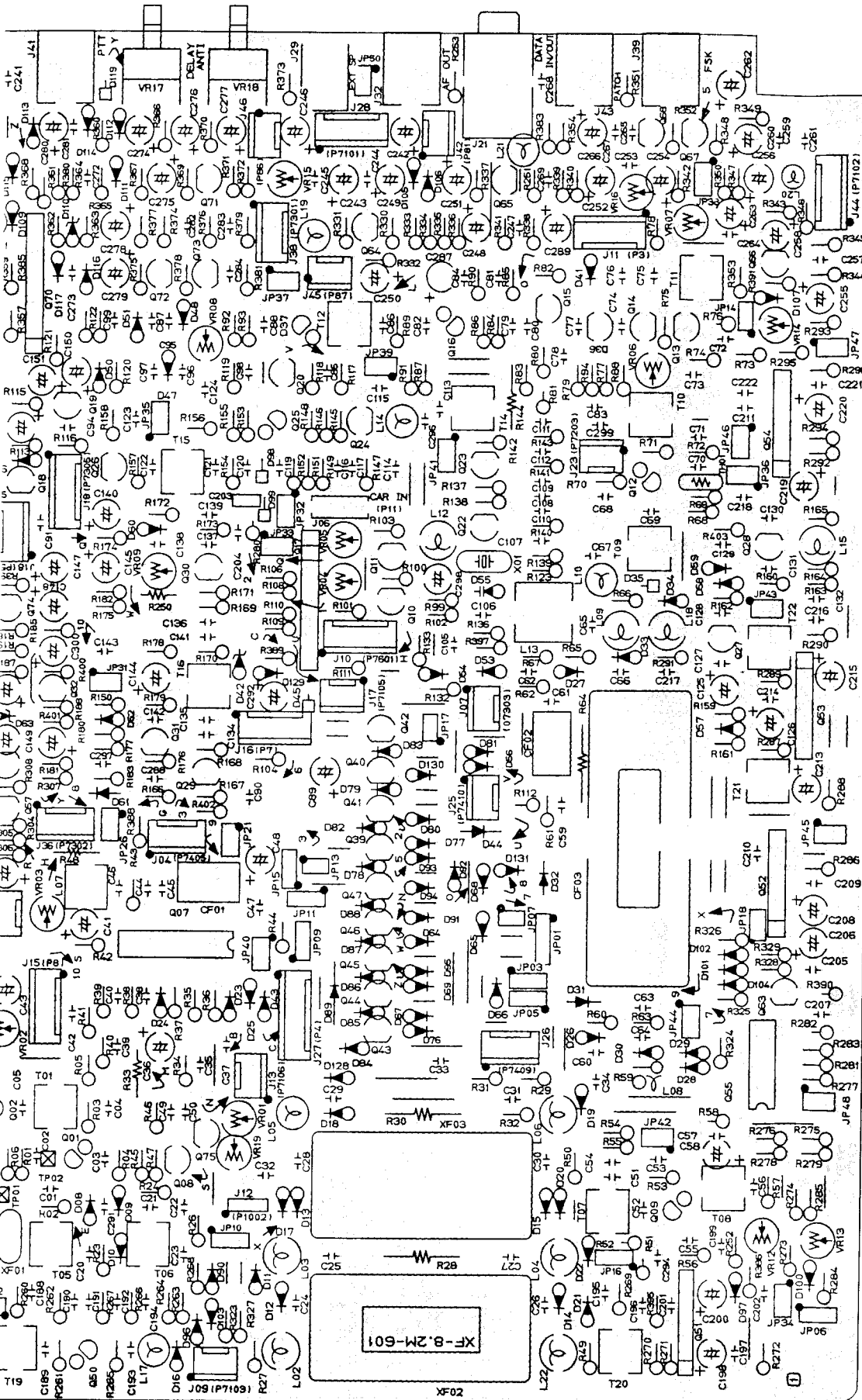

(Viewed from Component side)

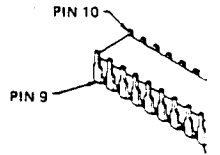

MC3359P (Q1)

PI
M

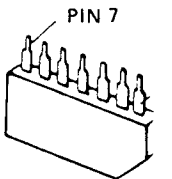

μPC1037H (Q1051),
TA7302P (Q1053)

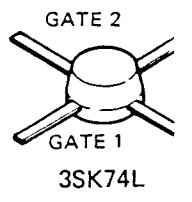

(Q1001,100;
1012,1011
1050

RTS LAYOUT

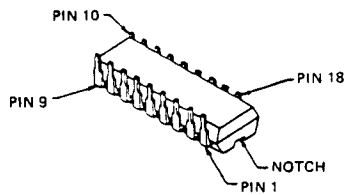
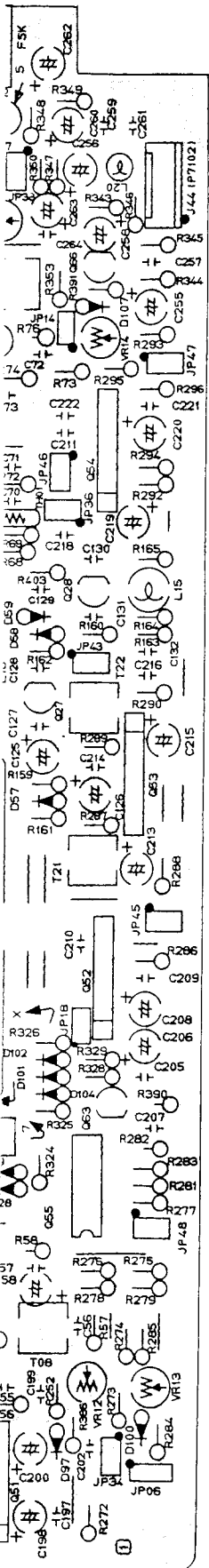

MC3359P (Q1007)

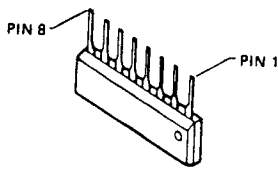

LA6458S (Q1017, 1036, 1070)

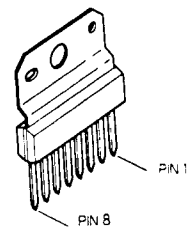

MB3713M-G (Q1037)

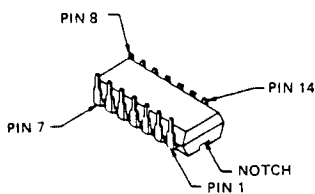

MC14066BCP (Q1038, 1055)

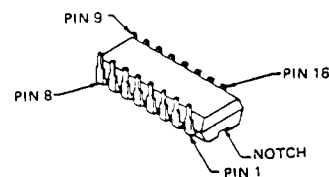

MC14049UBCP (Q1060)
TMS1751C (Q1059)

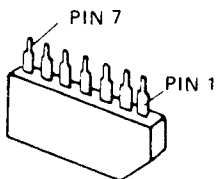

μPC1037H (Q1051, 1052, 1054)
TA7302P (Q1053)

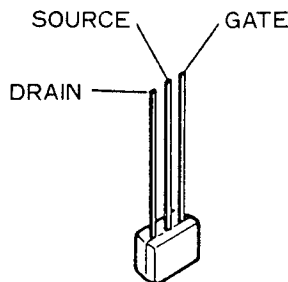

2SK104J
(Q1005, 1006, 1018)
1048, 1049, 1076
1077

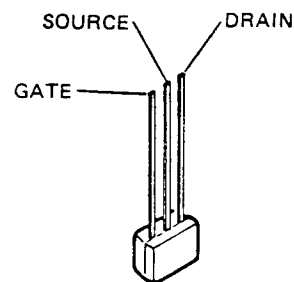

2SK192AGR (Q1011, 1031)
2SK241GR (Q1008)

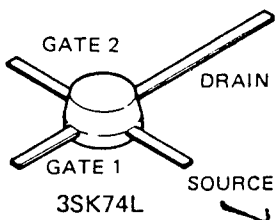

3SK74L
(Q1001, 1002, 1009)
1012, 1016, 1025
1050

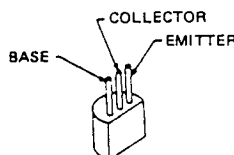

2SA733AP (Q1010, 1061, 1063)
2S0458LGC (1033-1035, 1074)
2S01923O (Q1021)
2S0945AQ
(Q1003, 1004, 1013-1015)
1019, 1020, 1022-1024
1026-1030, 1056-1058
1064-1069, 1071-1073

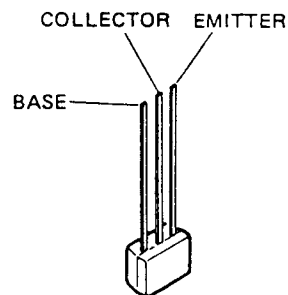

BN1A4P (Q1039-1047)
BA1A4M (Q1062, 1075)

IF UNIT PARTS LAYOUT

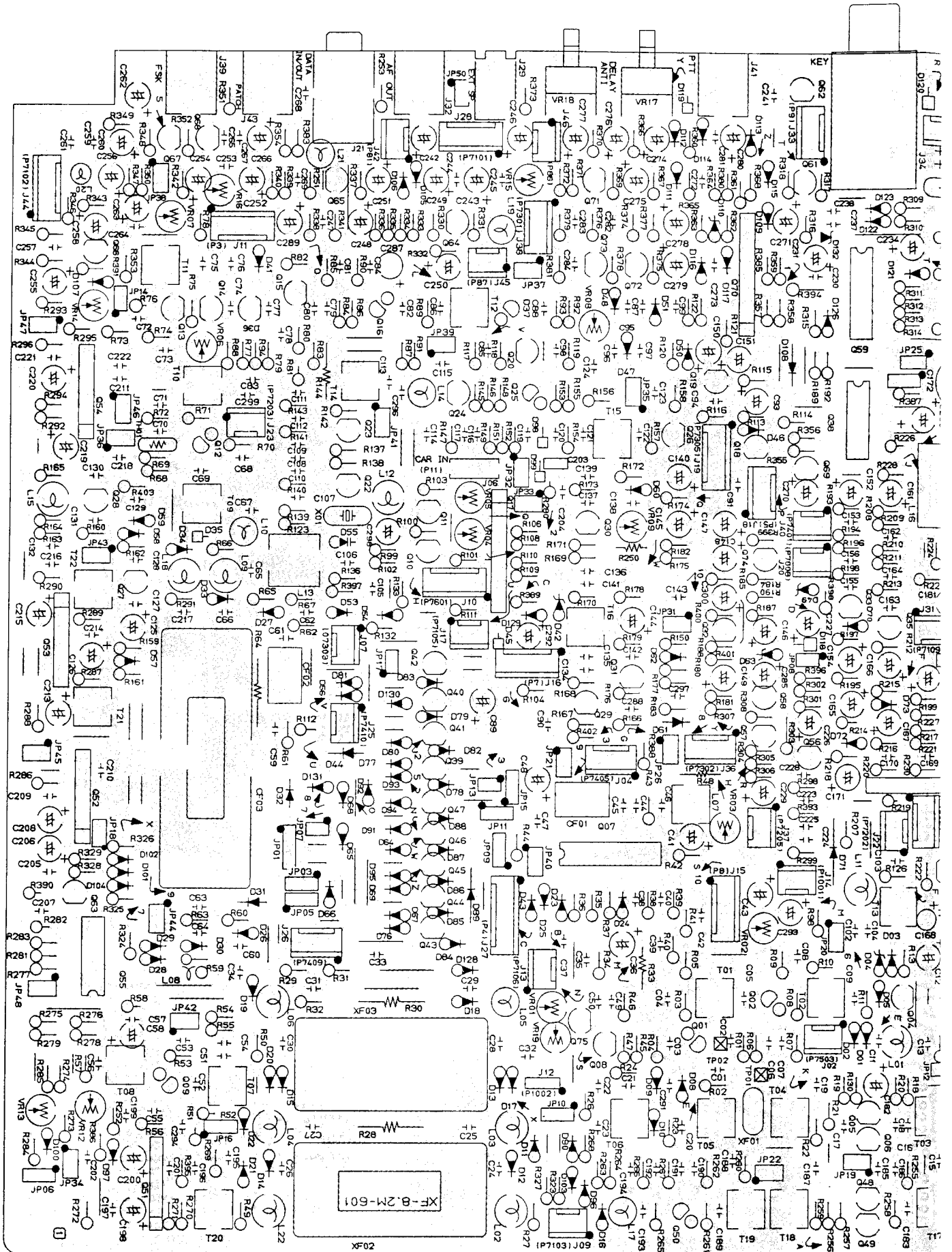

(Viewed from Solder)

IF UNIT PARTS LAYOUT

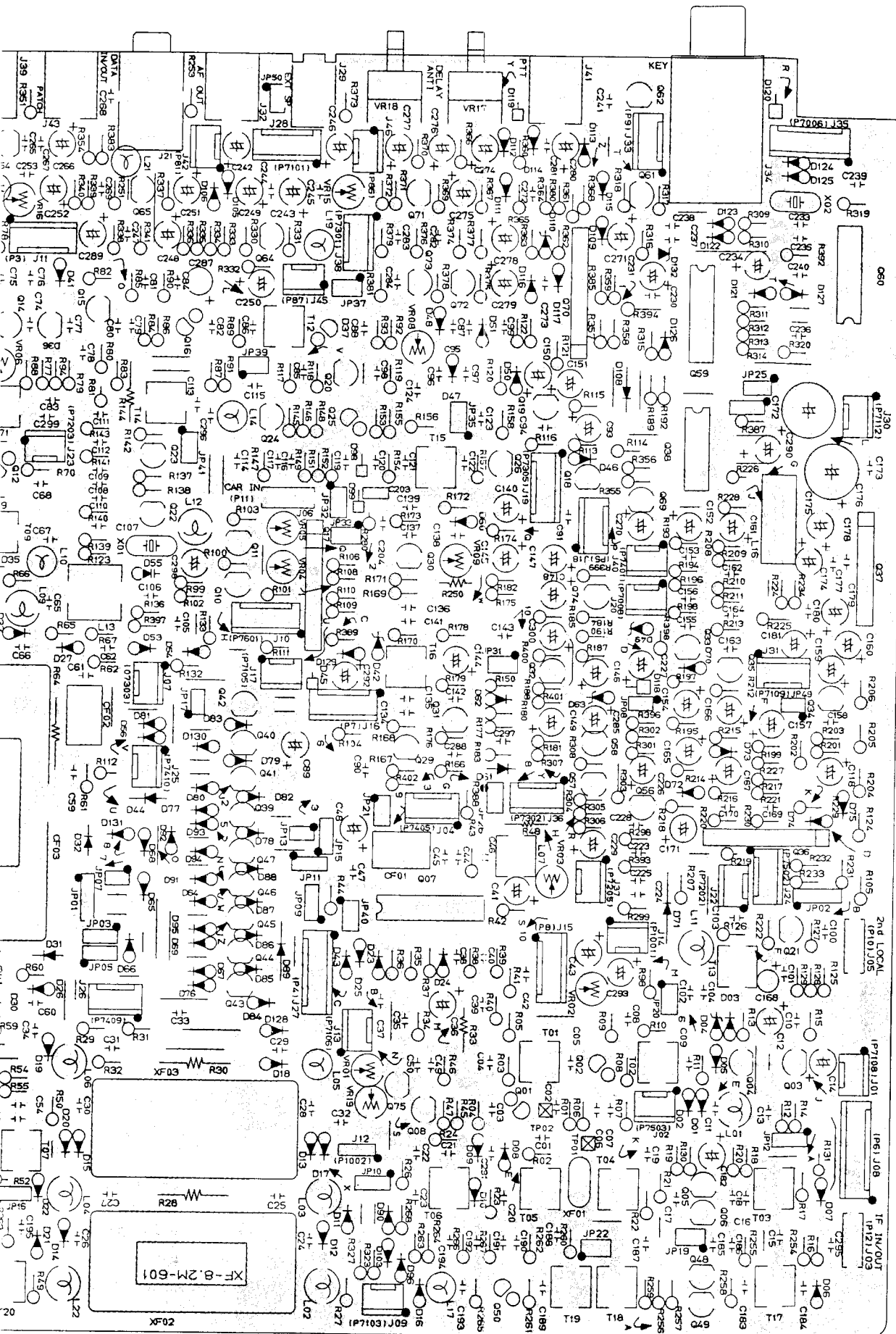

(Viewed from Solder side)

4
10
10
10
10
10
10
10
10
10
10
10
10
10
10
10

IF UNIT VOLTAGE CHART (DC VOLTS)

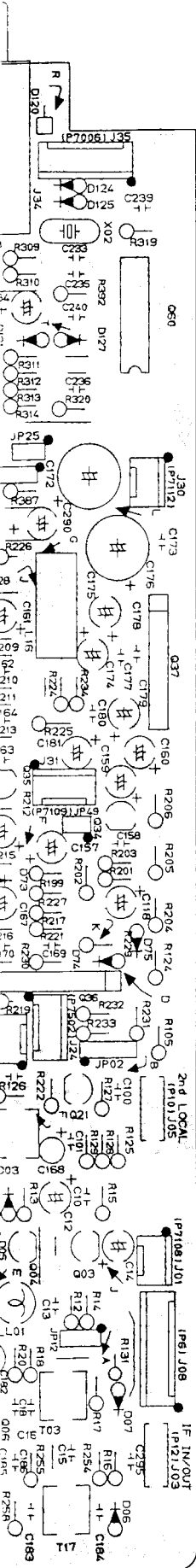

	E (S)		C (D)		B (G ₁)		(G ₂)		REMARKS
	R	T	R	T	R	T	R	T	
01001	0.4	0.4	7.5	7.5	0	0	4.0	4.0	NB ON
01002	0.4	0.4	7.5	7.5	0	0	4.0	4.0	NB ON
01003	- 7.2	- 7.2	4.0	4.0	- 7.2	- 7.2			NB ON
01004	- 6.8	- 6.8	- 2.2	- 2.2	- 7.2	- 7.2			NB ON
01005	1.5	0	13.0	13.2	0.4	- 3.8			
01006	1.5	0	13.0	13.2	0.4	- 3.8			
01008	1.0	1.0	7.8	7.8	0	0			MODE FM
01009	2.2	0	7.7	8.0	2.0	- 3.0	2.2	2.2	
01010	4.8	4.8	0	0	4.2	4.2			
01011	5.2	5.2	8.0	8.0	3.0	3.0			
01012	1.7	1.7	6.7	6.7	1.8	1.8	3.0	3.0	
01013	2.5	1.8	7.4	7.4	3.0	2.4			
01014	2.5	1.8	7.4	7.8	3.0	0			
01015	3.0	0	7.7	- 0.4	3.7	- 0.2			
01016	1.9	1.9	7.1	7.1	1.8	1.8	3.0	3.0	
01018	3.4	3.4	3.4	3.4	0	0			
01019	0	0	3.0	3.0	0	0			
01020	5.6	5.6	7.5	7.5	4.9	4.9			
01021	1.5	1.5	7.7	7.7	2.3	2.3			
01022	1.9	1.9	7.8	7.8	2.4	2.4			
01023	0.8	0.8	7.8	7.8	1.3	1.3			
01024	3.8	3.8	7.4	7.4	4.5	4.5			
01025	1.0	1.0	7.6	7.6	0.7	0.7	1.4	1.4	
01026	4.0	4.0	7.4	7.4	4.7	4.7			
01027	0	0	0	7.1	0	0			
01028	0	0.5	0	7.0	0	1.2			
01029	0	0.7	0	7.8	0	1.3			
01030	0.6	0.6	5.2	5.2	1.2	1.2			MODE AM
01031	2.6	2.6	3.5	3.5	0	0			
01033	3.8	3.8	6.1	6.1	4.5	4.5			
01034	1.2	1.2	4.3	4.3	1.9	1.9			
01035	4.3	4.3	7.3	7.3	4.9	4.9			
01039	0	8.0	- 0.5	7.9	0	1.0			MODE CW
01040	8.0	- 0.4	8.0	- 0.6	1.0	- 0.4			MODE CW
01041	0	8.0	- 0.6	8.0	0	0.9			MODE AM
01042	8.0	- 0.4	7.9	- 0.4	0.9	- 0.4			MODE AM
01043	8.0	8.0	8.0	8.0	1.6	1.6			MODE SSB
01044	8.0	8.0	8.0	8.0	1.0	1.0			MODE CW
01045	8.0	8.0	8.0	8.0	1.0	1.0			MODE AM
01046	8.0	8.0	8.0	8.0	0.9	0.9			MODE FM
01047	8.0	8.0	8.0	8.0	0.9	0.9			MODE FSK
01048	13.3	13.0	0	1.3	- 4.6	0			
01049	13.3	13.0	0	1.3	- 4.6	0			
01050	0.9	0.9	9.4	9.4	2.0	2.0	4.0	4.0	
01056	0.3	0.3	3.8	3.8	0.9	0.9			CW SEMI KEY DWN
01057	0	0	0	0	0.6	0.6			CW SEMI KEY DWN
01058	0	0	0	0	0.6	0.6			MODE CW
01061	1.1	1.1	1.8	1.8	1.8	1.8			CW SEMI KEY DWN
01062	0	0	0	0	1.8	1.8			CW SEMI KEY DWN
01063	0	8.0	0	7.8	0	7.2			PROC ON
01064	0.1	0.1	1.4	1.4	0.8	0.8			MODE FM
01065	0.2	0.2	2.7	2.7	0.9	0.9			MODE FM
01066	0	2.4	0	6.8	0	3.1			
01067	0.7	0.7	3.7	3.7	1.4	1.4			
01068	0.1	0.1	1.4	1.4	0.7	0.7			
01069	0	0	7.4	0.1	0	0			VOX ON
01071	0.6	0.6	3.5	3.5	1.2	1.2			
01072	0.8	0.8	4.9	4.9	1.5	1.5			
01073	0.1	0.1	1.5	1.5	0.7	0.7			
01074	0	0.8	0	3.5	0	1.4			MONI ON
01075	0	0	0	1.3	2.1	0			TONE SOL ON (FTS-B)
01076	1.4	3.7	8.0	8.0	2.2	4.0			
01077	1.7	1.7	7.9	7.9	0	0			MODE FM

IF UNIT IC VOLTAGE CHART (DC VOLTS)

PIN No.		1	2	3	4	5	6	7	8	9	10	11	12	13	14	15	16	17	18	REMARKS
Q1007	RX	7.4	0	7.5	1.0	1.1	1.1	7.3	4.5	3.7	4.7	—	2.5	2.6	0.7	0	0	0	2.1	MODE FM
	TX	7.3	0	7.4	1.0	1.1	1.1	7.3	4.1	3.4	6.6	—	2.4	2.6	0.7	0	0	0	2.1	
Q1017	RX	8.0	6.9	3.5	3.0	-6.0	3.4	3.7	-6.0	8.0										
	TX	8.0	-6.0	0	-3.5	-7.3	0	0	0	8.0										
Q1037	RX	6.8	13.2	12.5	0	0	0	0.6	0.6											
Q1038	RX	0	0	0	0	5.6	6.6	-0.7	0	0	0	0	0	-0.2	8.0					
	TX	0	0	0	0	0	6.6	-0.7	0	0	0	0	0	-0.2	8.0					
Q1051	RX	6.3	5.6	4.9	0	2.8	2.8	2.8												
Q1052	RX	0	0	0	0	0	0	0												PROC ON
	TX	6.3	5.6	5.1	0	2.8	2.8	2.8												
Q1053	RX	0	0	0	0	0	0	0												PROC ON
	TX	2.6	2.6	3.7	0	5.6	6.5	6.5												
Q1054	RX	0	0	0	0	0	0	0												PROC ON
	TX	6.2	5.4	4.7	0	2.8	2.8	2.8												
Q1055	RX	2.0	2.0	2.0	2.0	6.4	0	0	0.5	0.4	0	6.4	0	0	8.0					
	TX	2.0	2.0	2.0	2.0	6.4	0	0	0.5	0.4	5.8	5.8	8.0	5.8	8.0					
Q1059	RX	—	—	—	—	—	—	—	0	—	—	—	—	—	—	—	—	—	50	
Q1060	RX	5.0	—	—	—	—	—	—	—	—	—	—	—	—	—	—	—	—	—	
Q1070	RX	8.0	-5.9	6.8	2.7	-7.2	-5.9	1.0	-5.9	8.0										

IF UNIT CIRCUIT 1

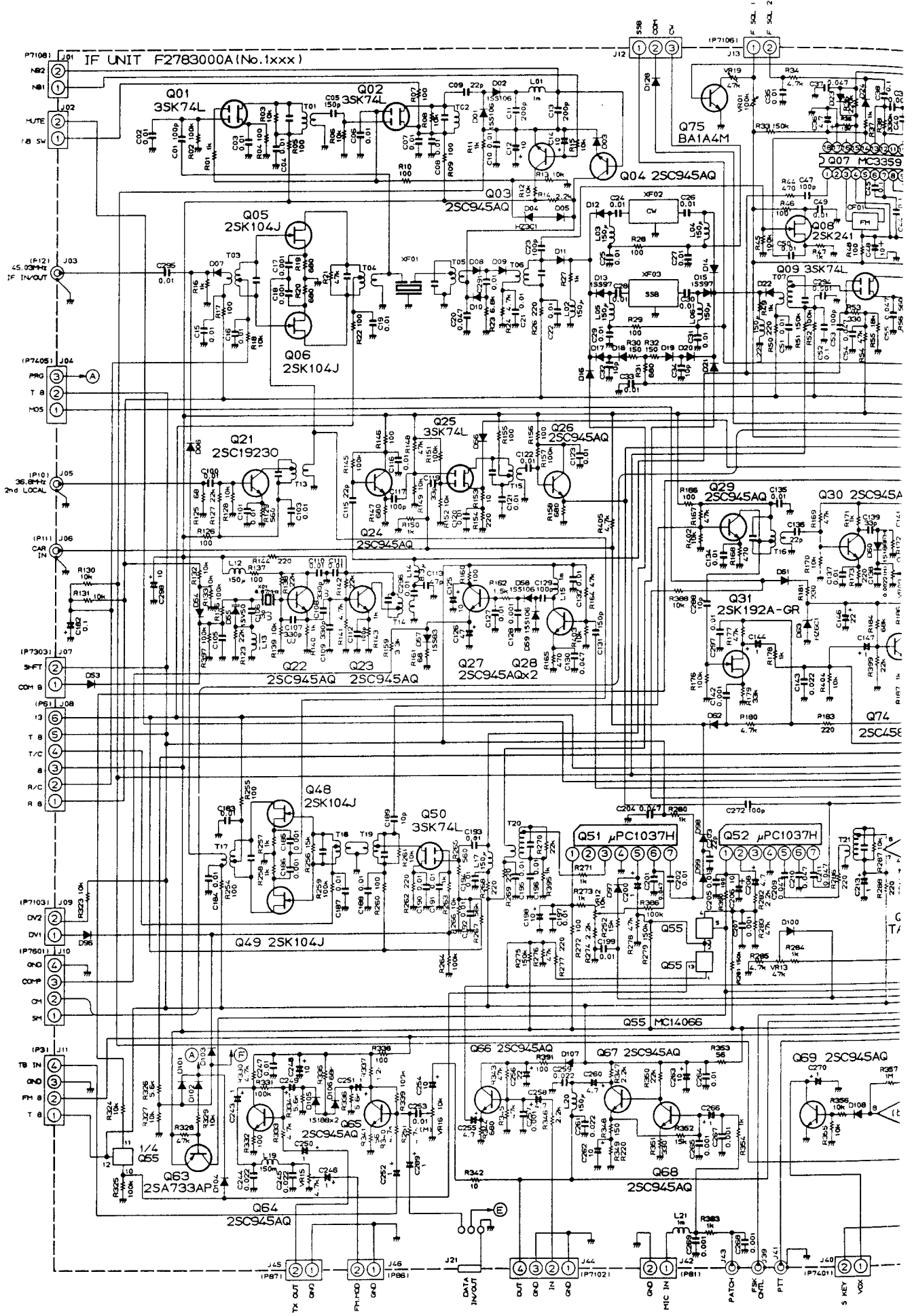

IF UNIT CIRCUIT DIAGRAM

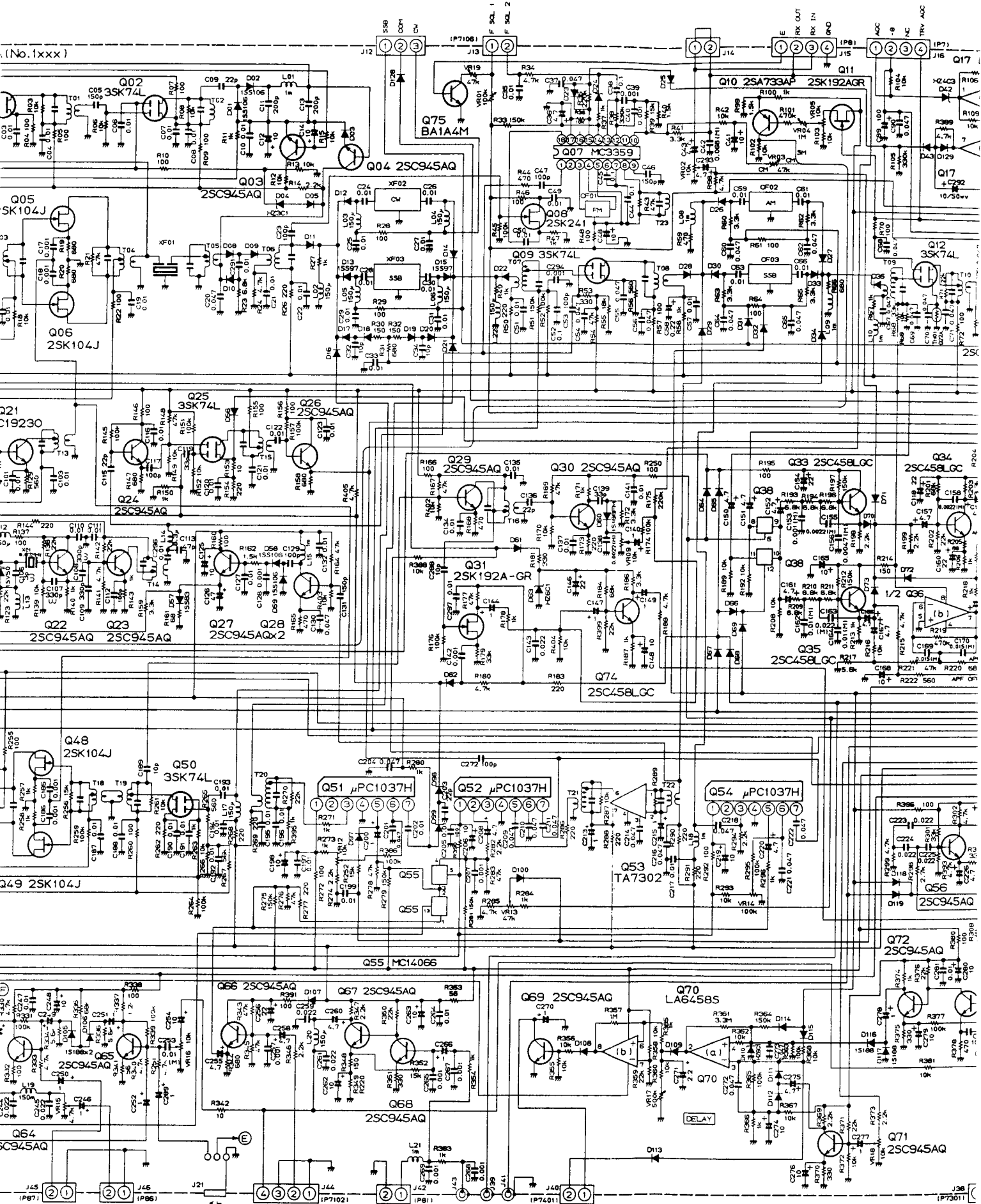

RESISTOR VALUES ARE IN Ω, 1/4W; CAPACITOR VALUES ARE IN μF;
 AND INDUCTOR VALUES ARE IN H; UNLESS OTHERWISE NOTED.
 (M) CAPACITORS ARE POLYESTER FILM, 50V.
 DIODES ARE TYPE 1S553 UNLESS OTHERWISE NOTED.

UNIT DIAGRAM

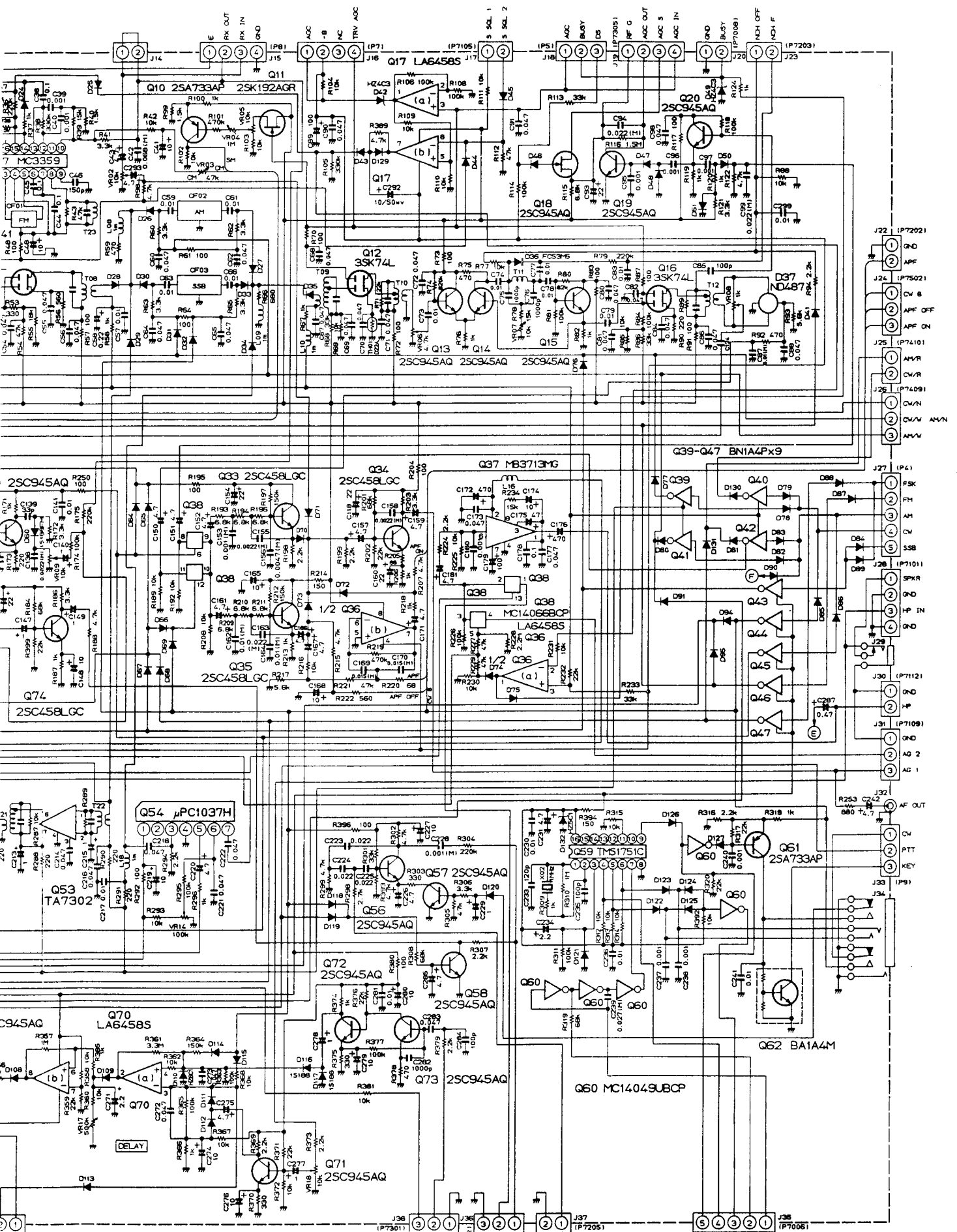

RESISTOR VALUES ARE IN Ω , $k\Omega$; CAPACITOR VALUES ARE IN μF ;
 AND INDUCTOR VALUES ARE IN H; UNLESS OTHERWISE NOTED.
 1M1 CAPACITORS ARE POLYESTER FILM, 50V.
 DIODES ARE TYPE 15583 UNLESS OTHERWISE NOTED.

RF UNIT PARTS LAYOUT

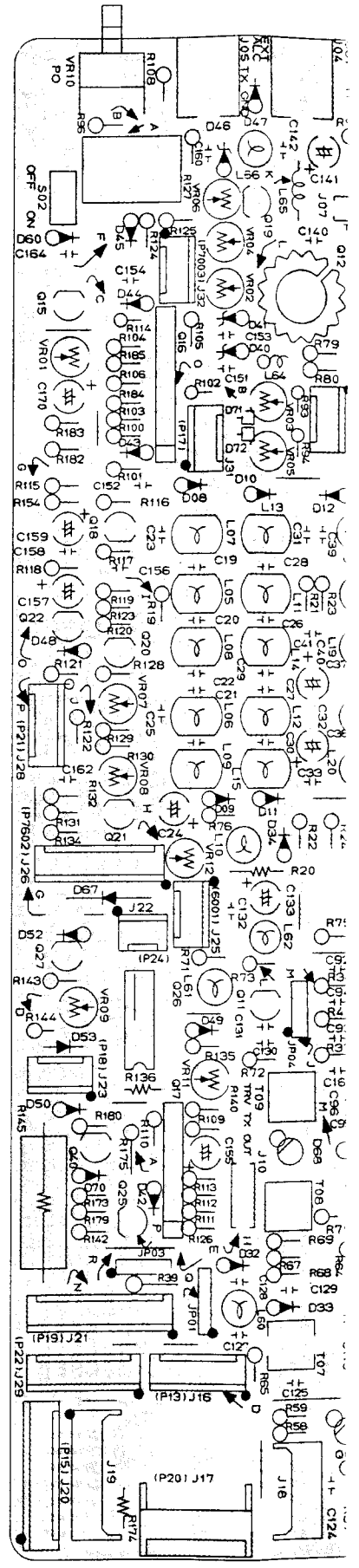
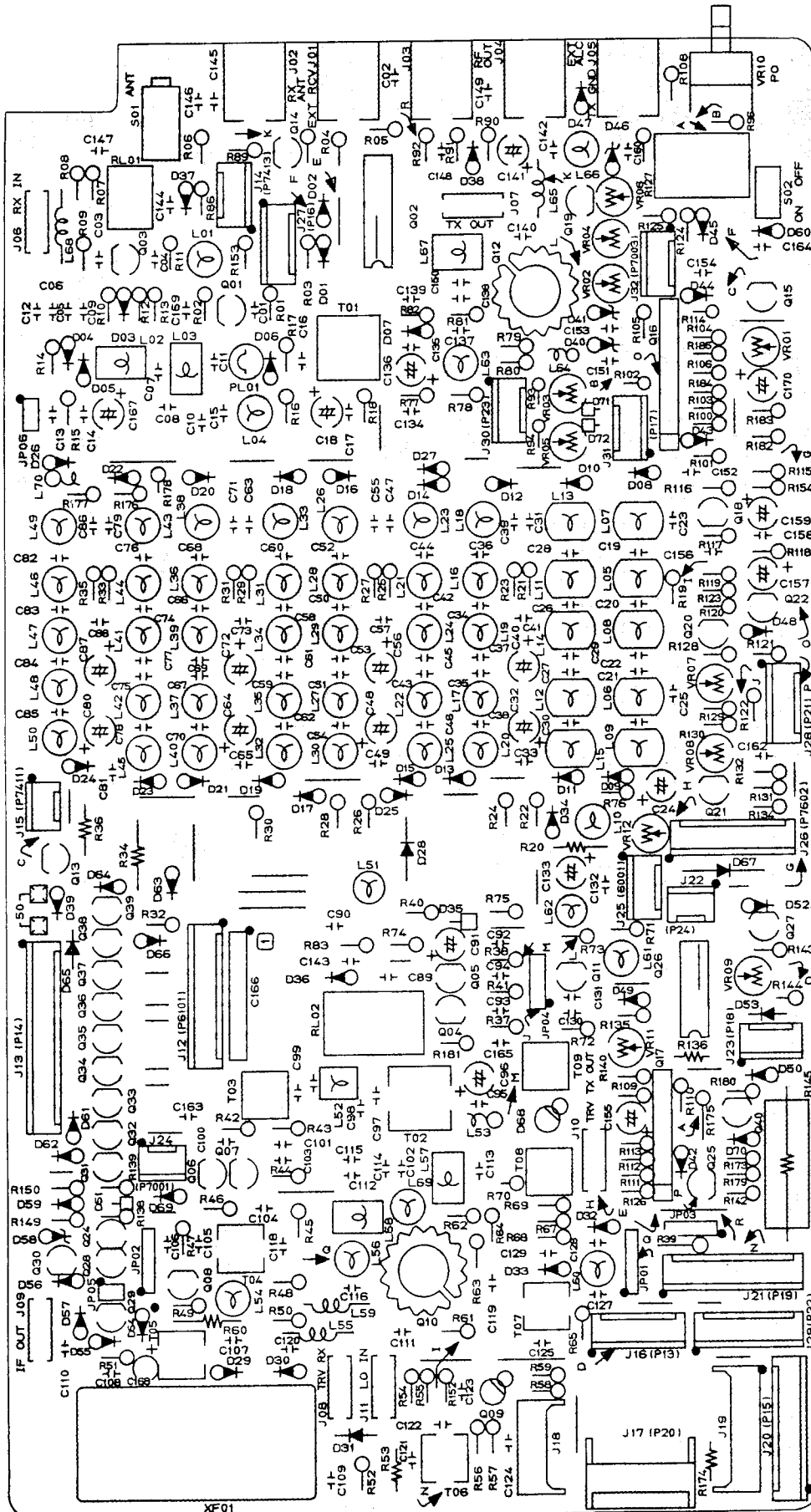

(Viewed from Component side)

RF UNIT PARTS LAYOUT

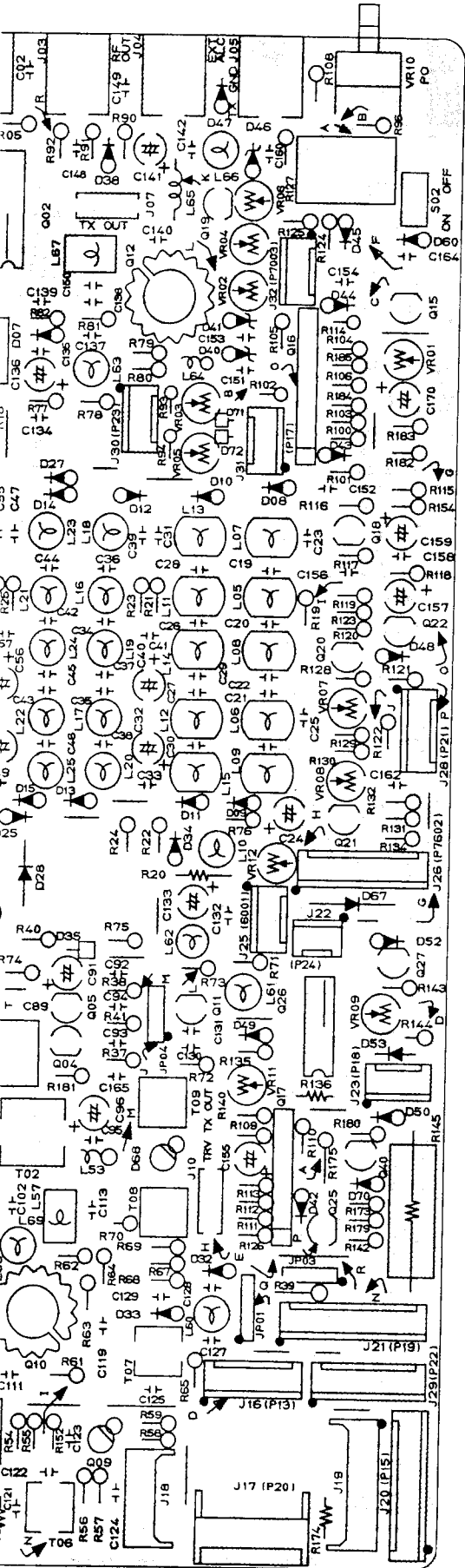

(Viewed from Component side)

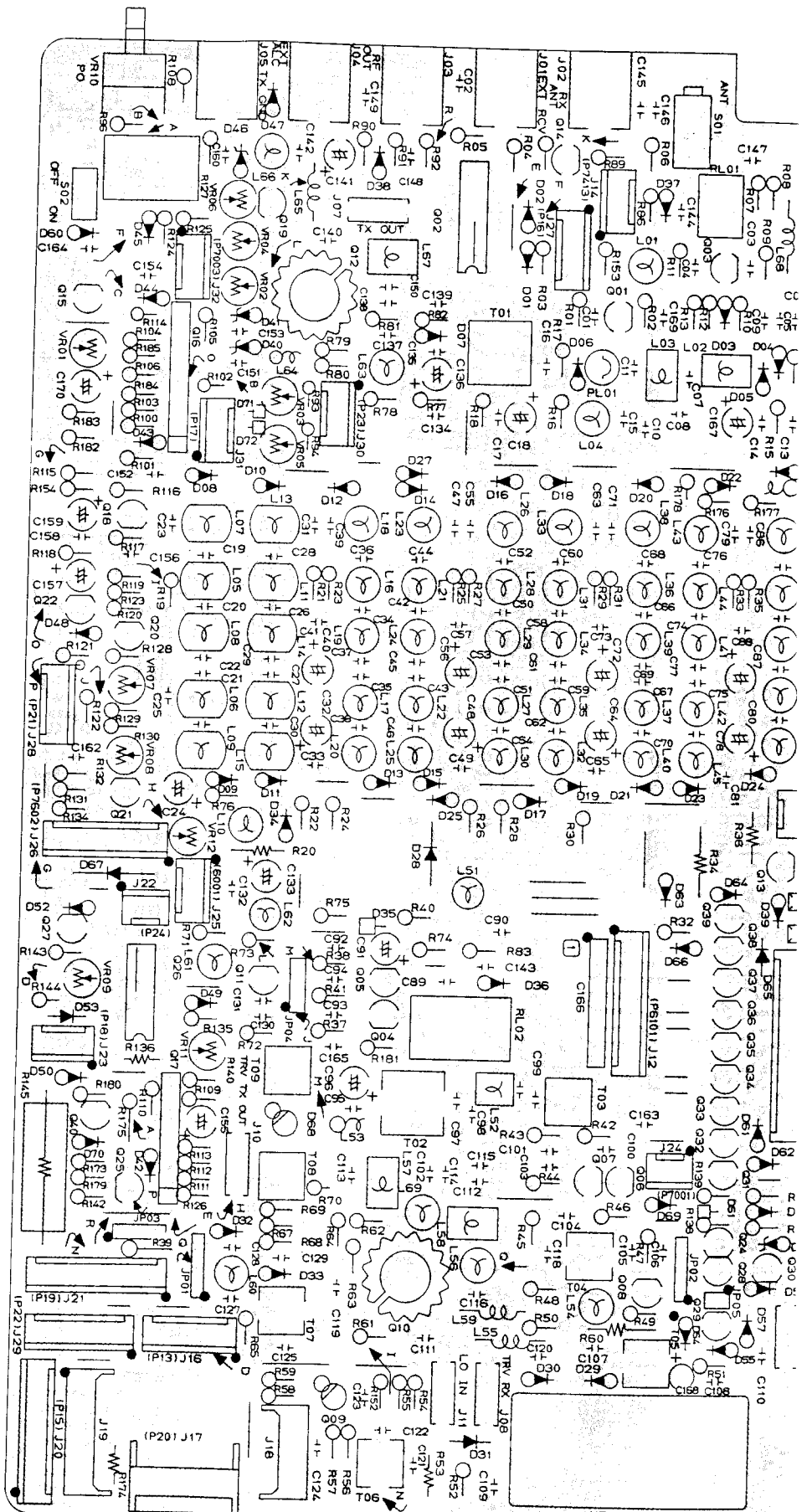

(Viewed from Solder side)

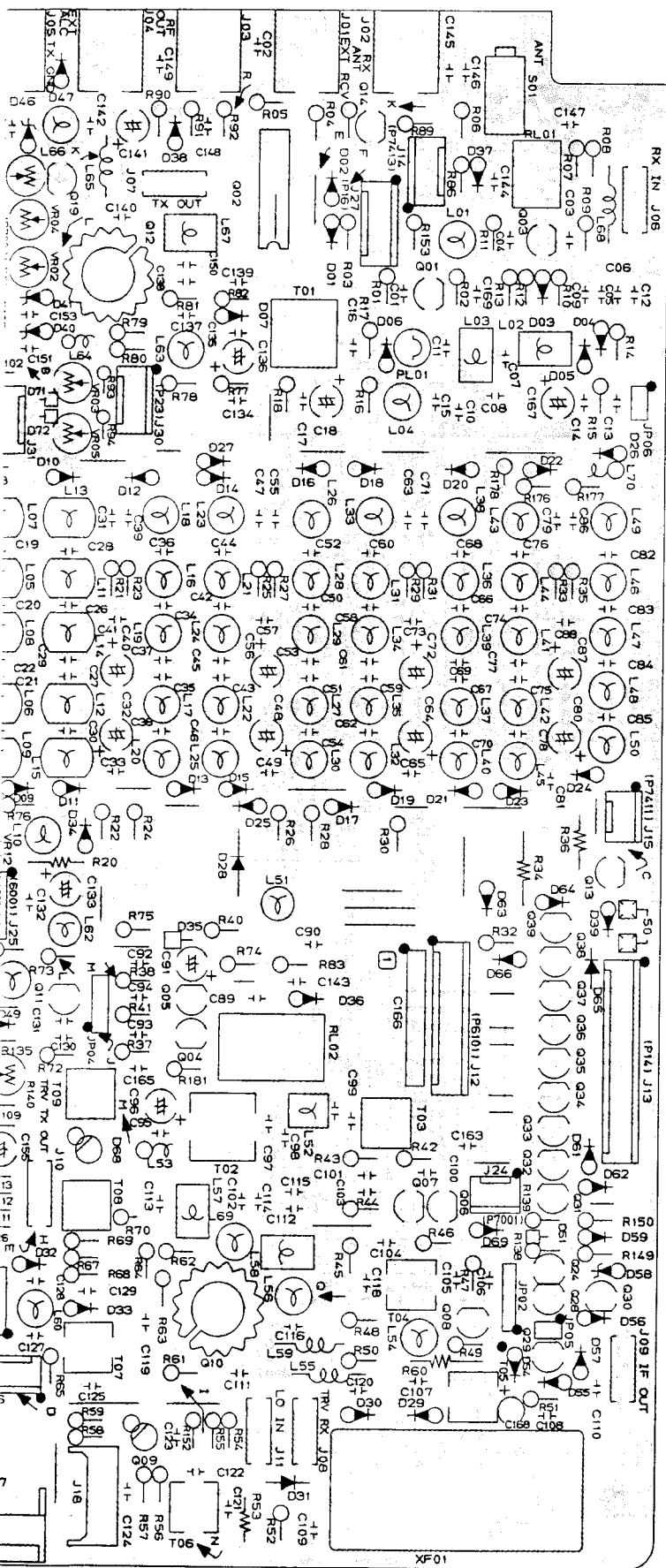

(Viewed from Solder side)

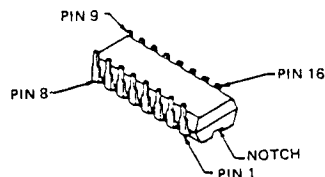

MC14518BCP (Q2002)

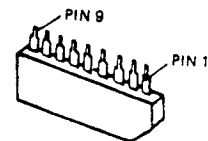

LA6458S (Q2016)

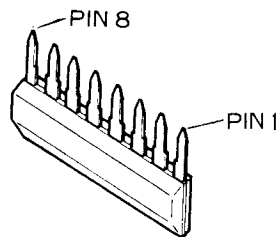

M5218 (Q2017)

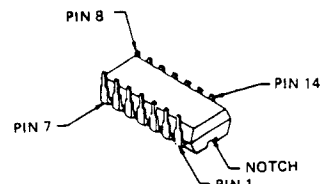

MC14066BCP (Q2026)

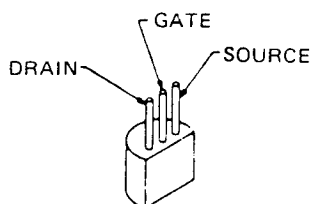

2SK125 (Q2004-2008,2011)
2SK104J (Q2020,2025)

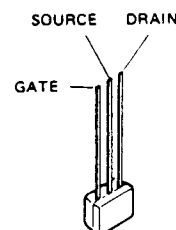

2SK192A-GR (Q2019)

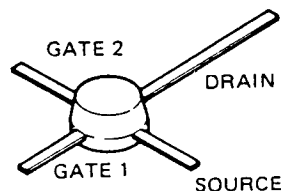

3SK74L (Q2009)

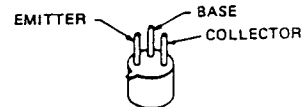

2N4427 (Q2010,2012)

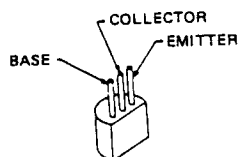

2SA733AP
(Q2021,2024,2027)

2SC945AQ
(Q2001,2003,2018)
2030,2040

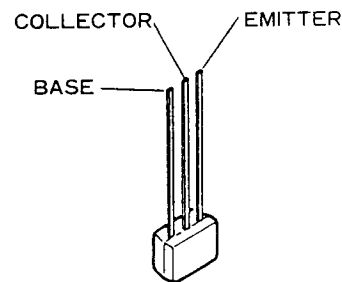

BA1A4M (Q2014,2015)
BN1A4P
(Q2013,2028,2029)
2031-2039

100W PA UNIT PARTS LAYOUT

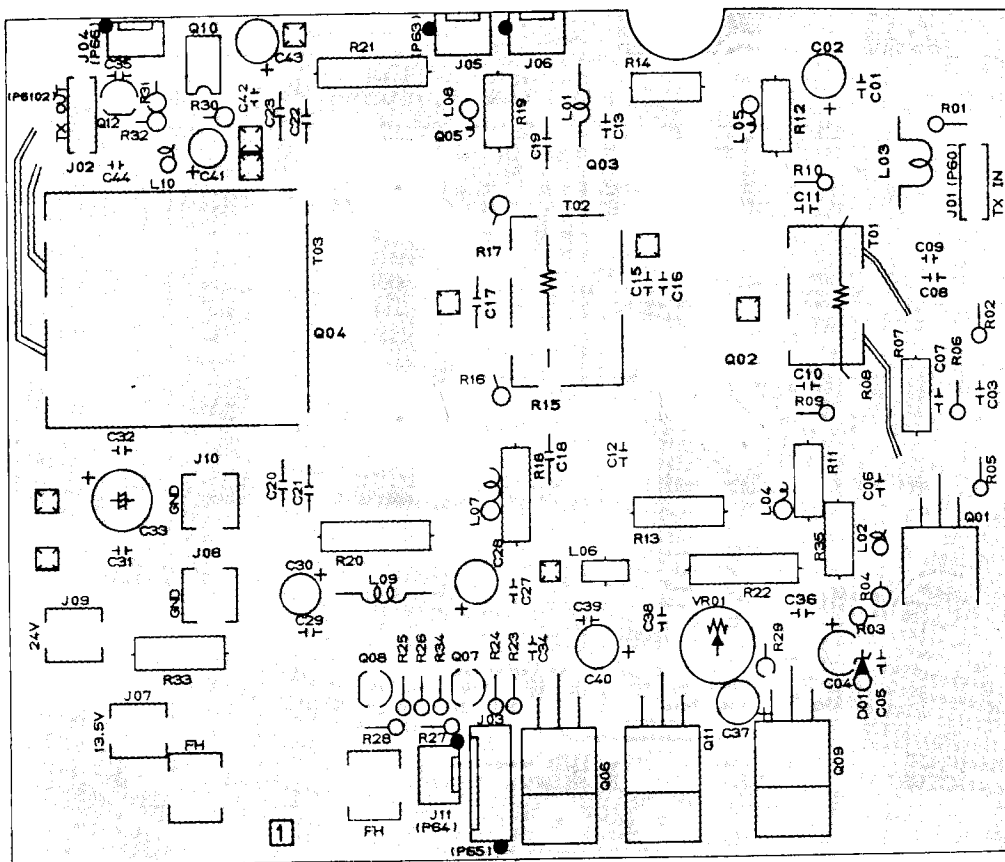

(Viewed from Component side)

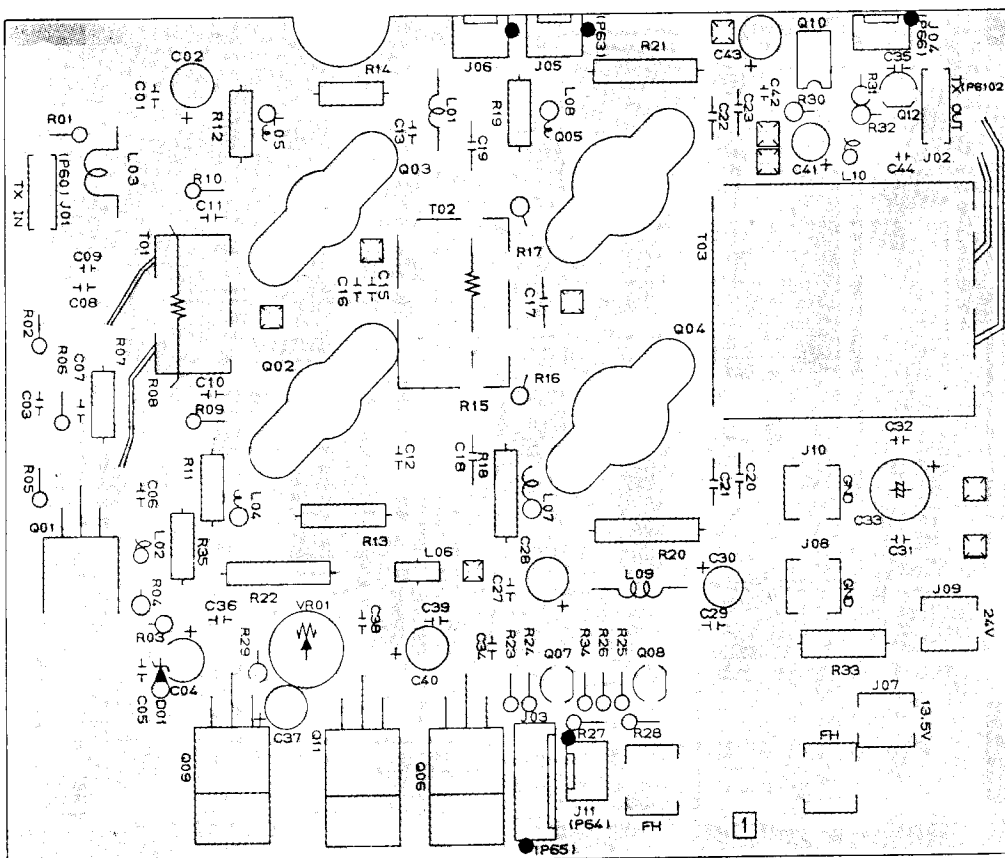

(Viewed from Solder side)

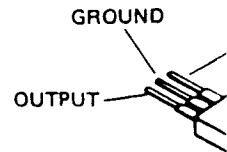

GR
μPC7808H (Q900)

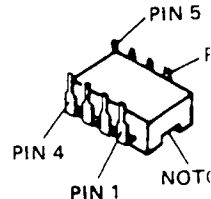

TL7705CPB (Q901)

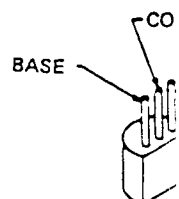

2SA952L (Q902)
2SC458B (Q903)

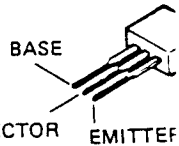

2SA1012Y (Q904)

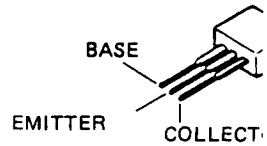

2SC1971 (Q905)

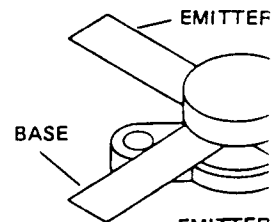

2SC2395 (Q906)
MRF422 (Q907)

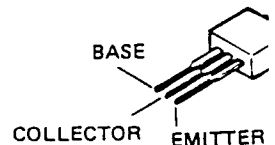

2SD8800 (Q908)

100W PA UNIT PARTS LAYOUT

100V

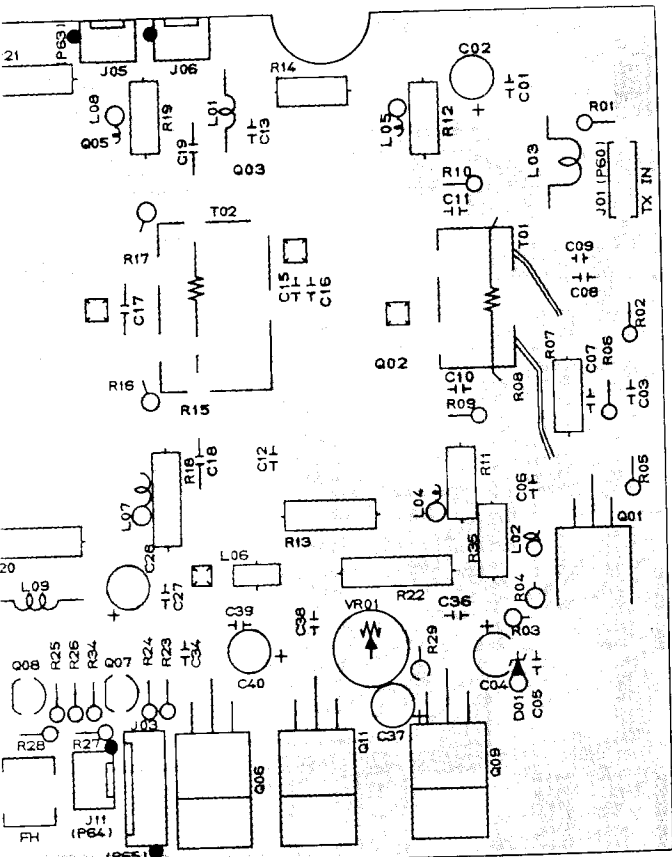

(Viewed from Component side)

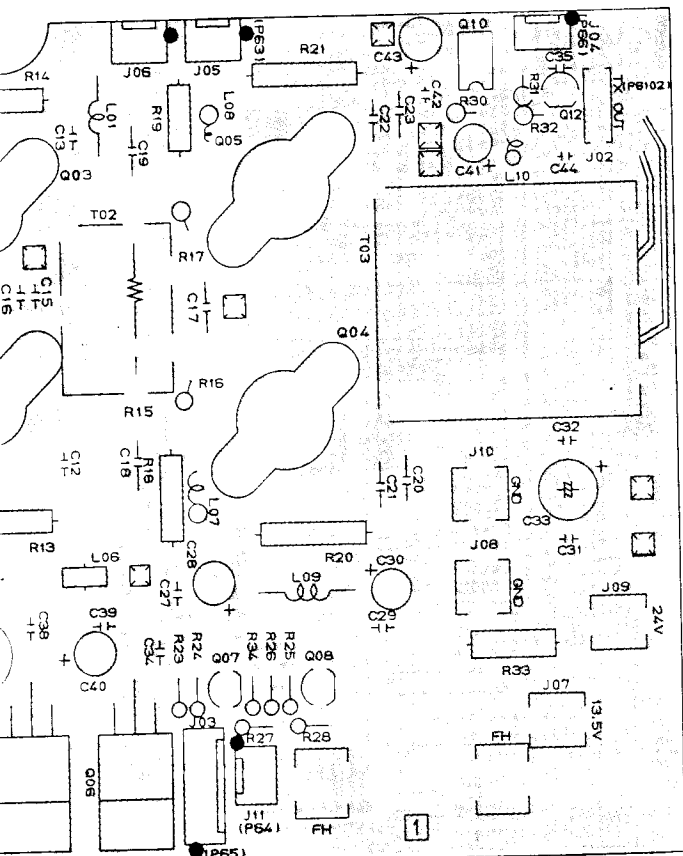

(Viewed from Solder side)

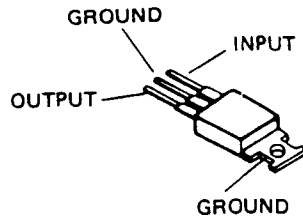

μPC7808H (Q9009)

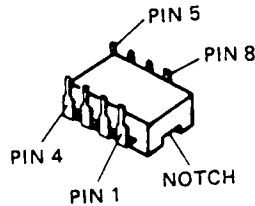

TL77050PB (Q9010)

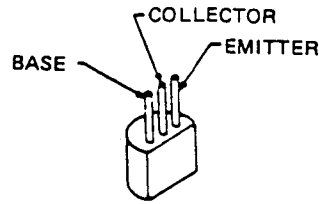

2SA952L (Q9012)
2SC458B (Q9007,9008)

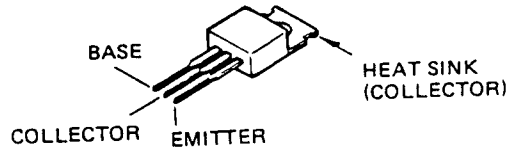

2SA1012Y (Q9006)

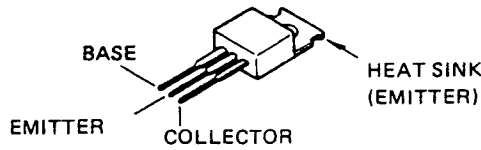

2SC1971 (Q9001)

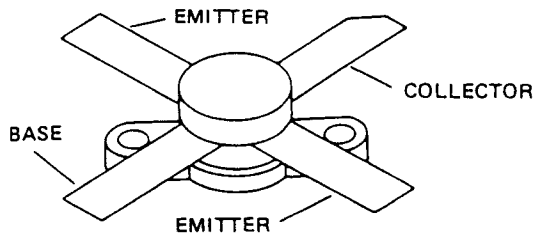

2SC2395 (Q9002,9003)
MRF422 (Q9004,9005)

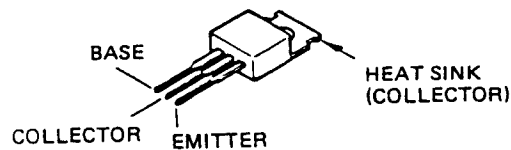

2SD880O (Q9011)

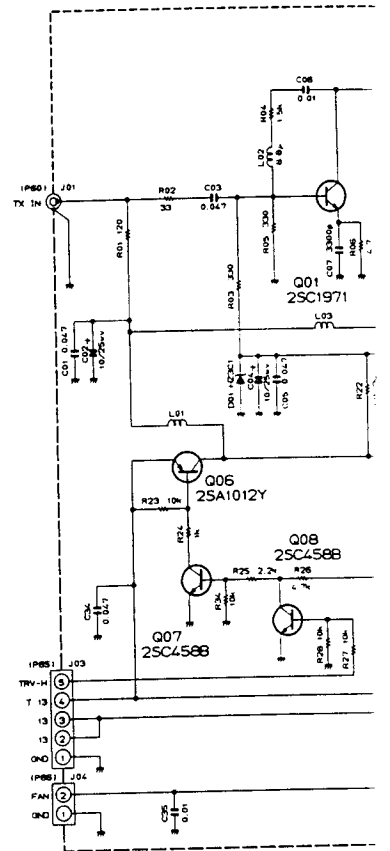

RESISTOR VALUES ARE IN Ω; CAPACITOR VAL AND INDUCTOR VALUES ARE μ; UNLESS OTHERWISE (M) CAPACITORS ARE POLYESTER FILM 50V. (S) CAPACITORS ARE SEMI-CONDUCTOR CERAMIC 25V.

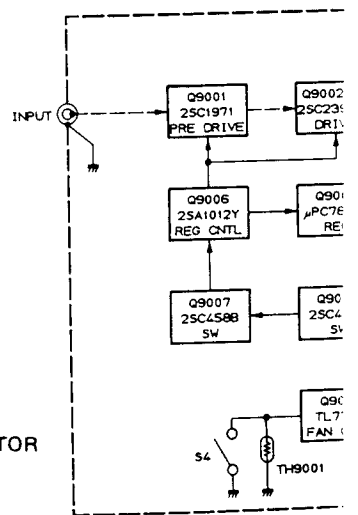

100W PA UNIT CIRCUIT DIAGRAM

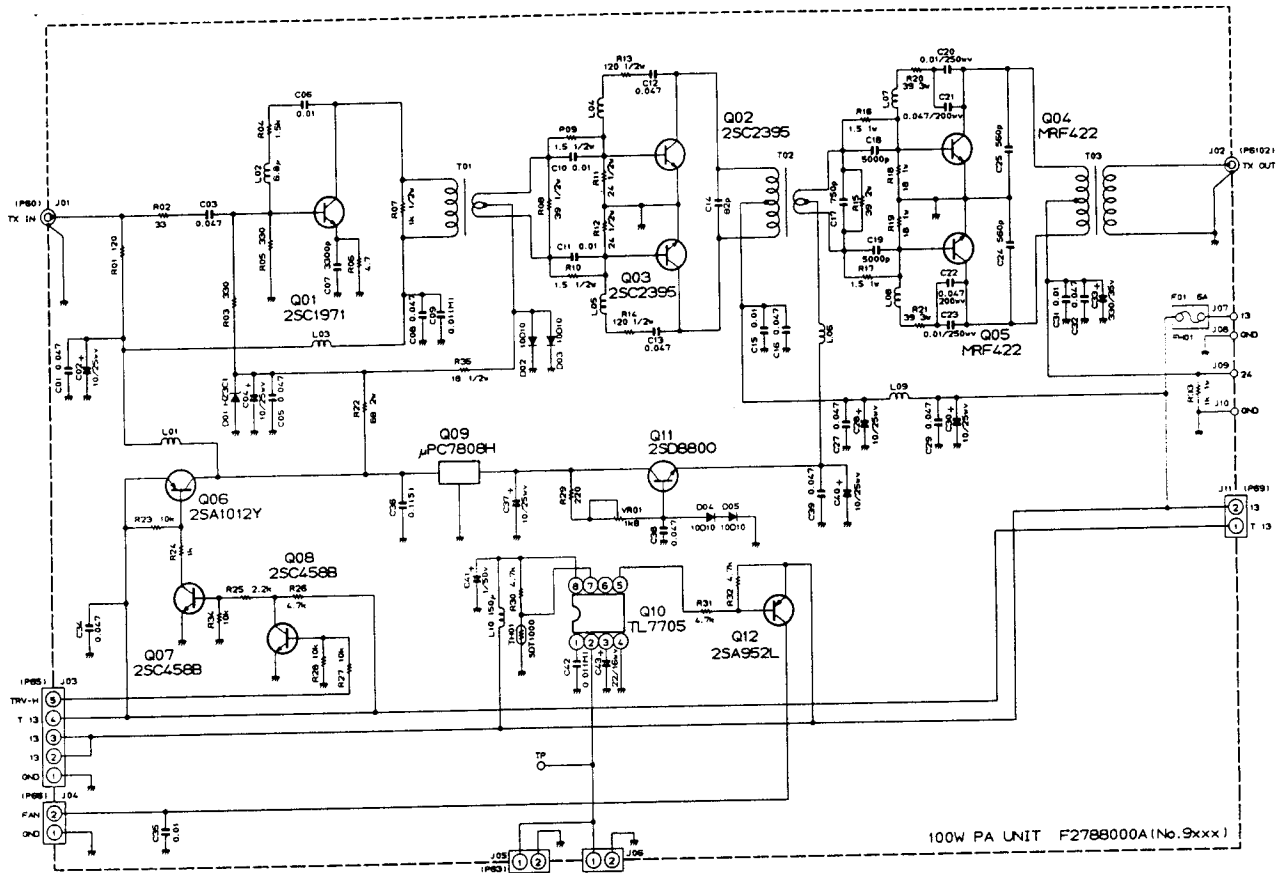

RESISTOR VALUES ARE IN Ω , μ , k , M ; CAPACITOR VALUES ARE IN μ , F , AND INDUCTOR VALUES ARE H; UNLESS OTHERWISE NOTED.
 (M) CAPACITORS ARE POLYESTER FILM, 50V.
 (S) CAPACITORS ARE SEMICONDUCTOR CERAMIC, 25V.

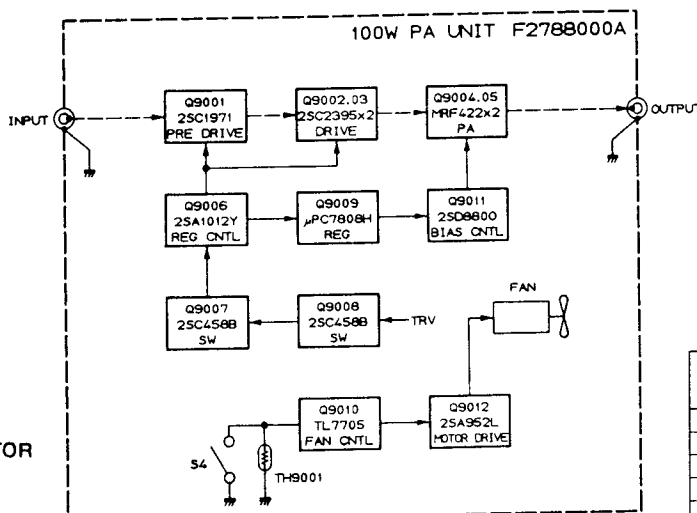

--- TRANSMIT
 — CONTROL

100W PA UNIT VOLTAGE CHART (DC VOLTS)

	E (S)		C (D)		B (G.)		REMARKS
	R	T	R	T	R	T	
Q9001	0	0.5	0	13.0	0	1.3	
Q9002	0	0	13.3	13.3	0	0.7	
Q9003	0	0	13.3	13.3	0	0.7	
Q9004	0	0	23.5	23.5	0	0.7	
Q9005	0	0	23.5	23.5	0	0.7	
Q9006	0	13.3	0	13.0	0	12.2	
Q9007	0	0	0	0	0.7	0.7	
Q9008	0	0	0	0	0.7	0.7	TRV
Q9009	IN 13.0	13.0	0	0	0	8.0	
Q9011	0	0.8	0	8.0	0	1.4	
Q9012	13.3	13.3	5.2	5.2	13.0	13.0	FAN SLOW

100W PA UNIT IC VOLTAGE CHART (DC VOLTS)

PIN No.	1	2	3	4	5	6	7	8
Q9010	—	—	—	0	—	—	—	13.0

TUNER UNIT PARTS LAYOUT

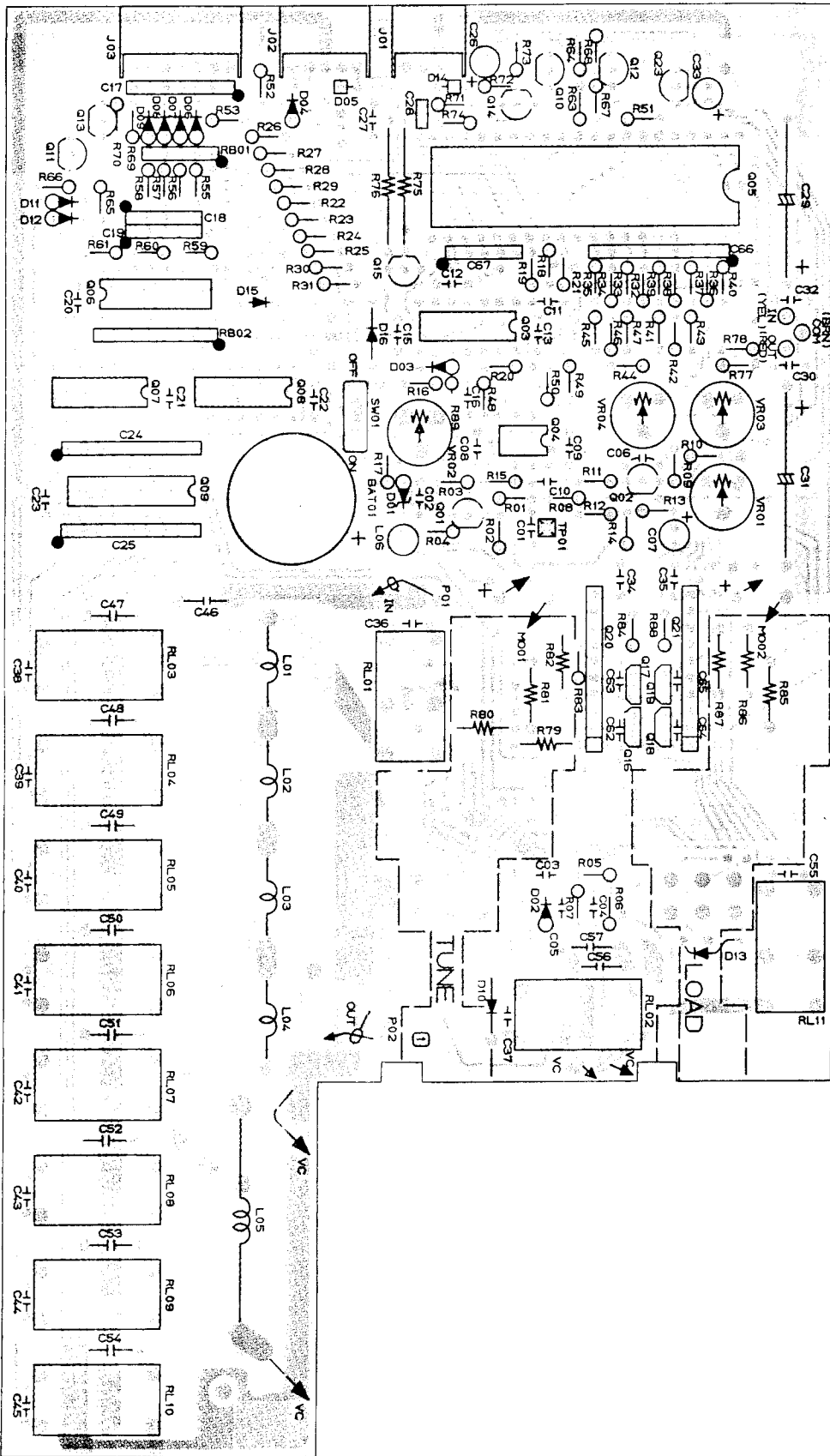

(Viewed from Component side)

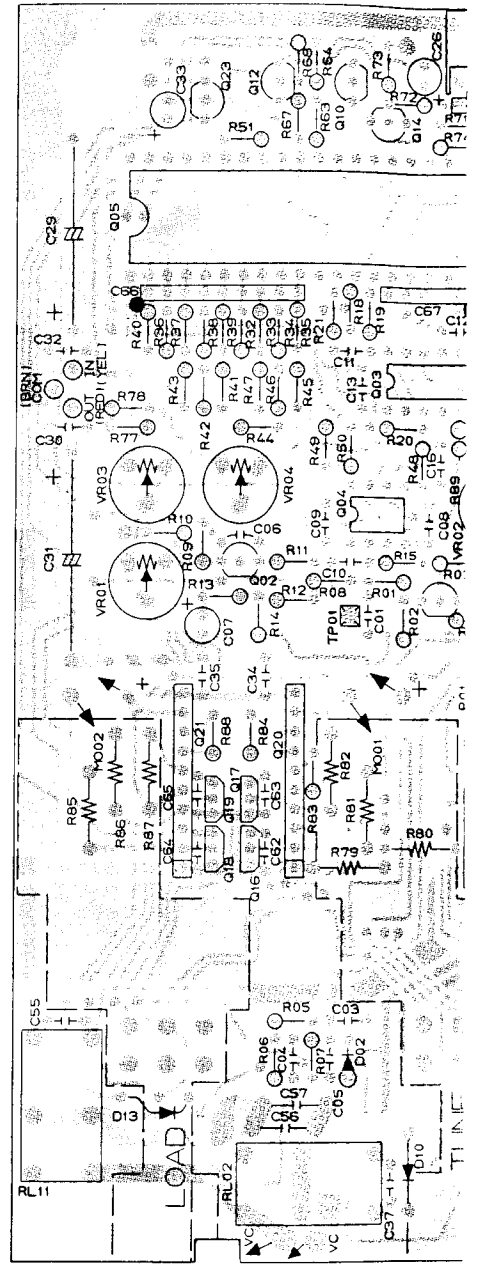

TUNER UNIT PARTS LAYOUT

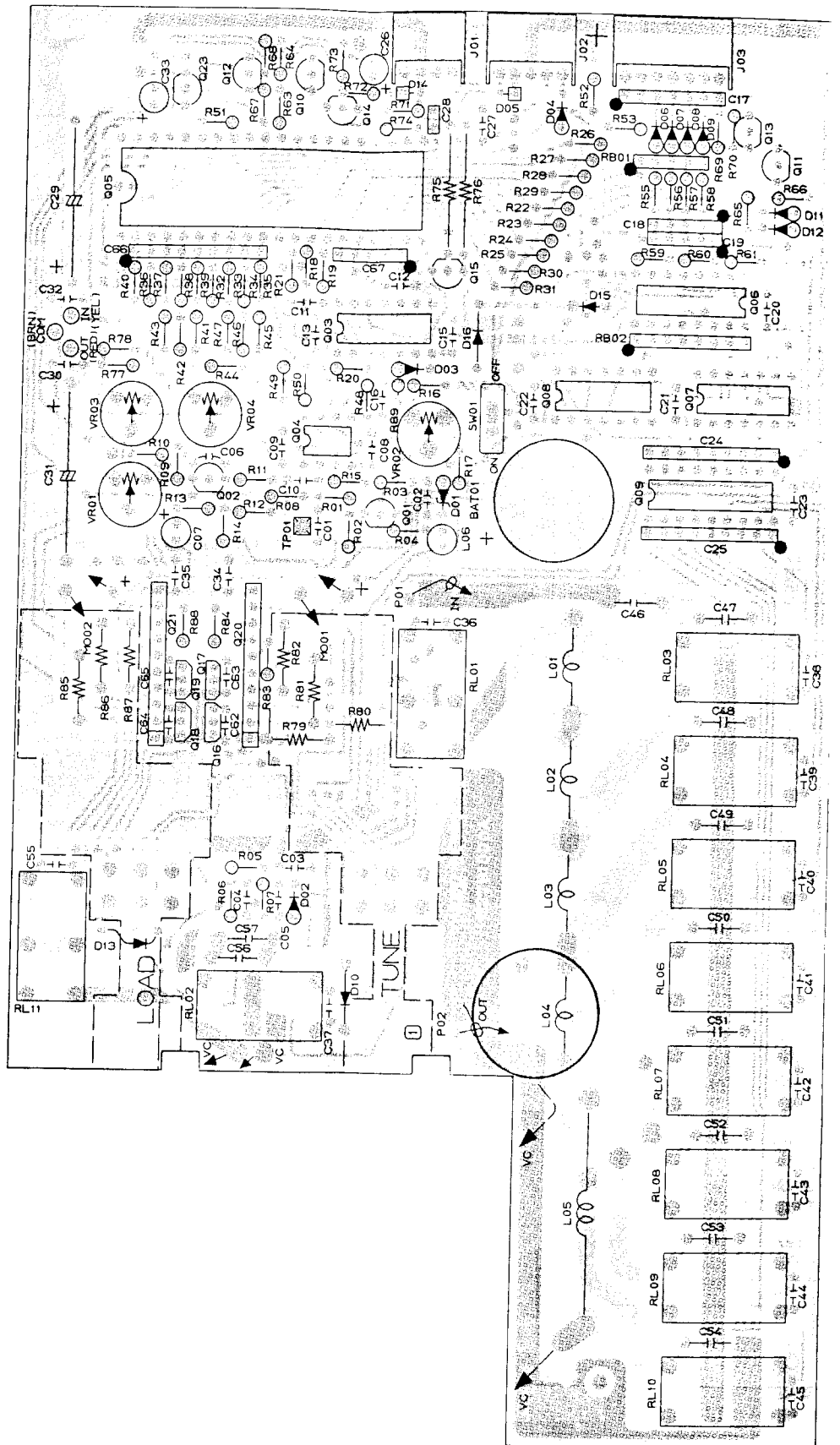
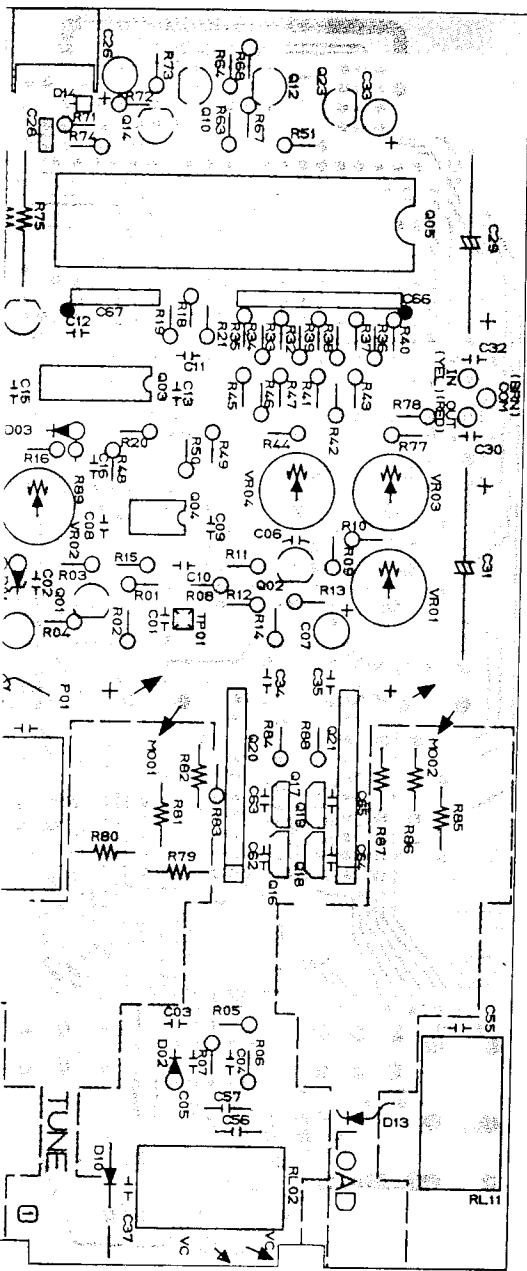

(Viewed from Solder side)

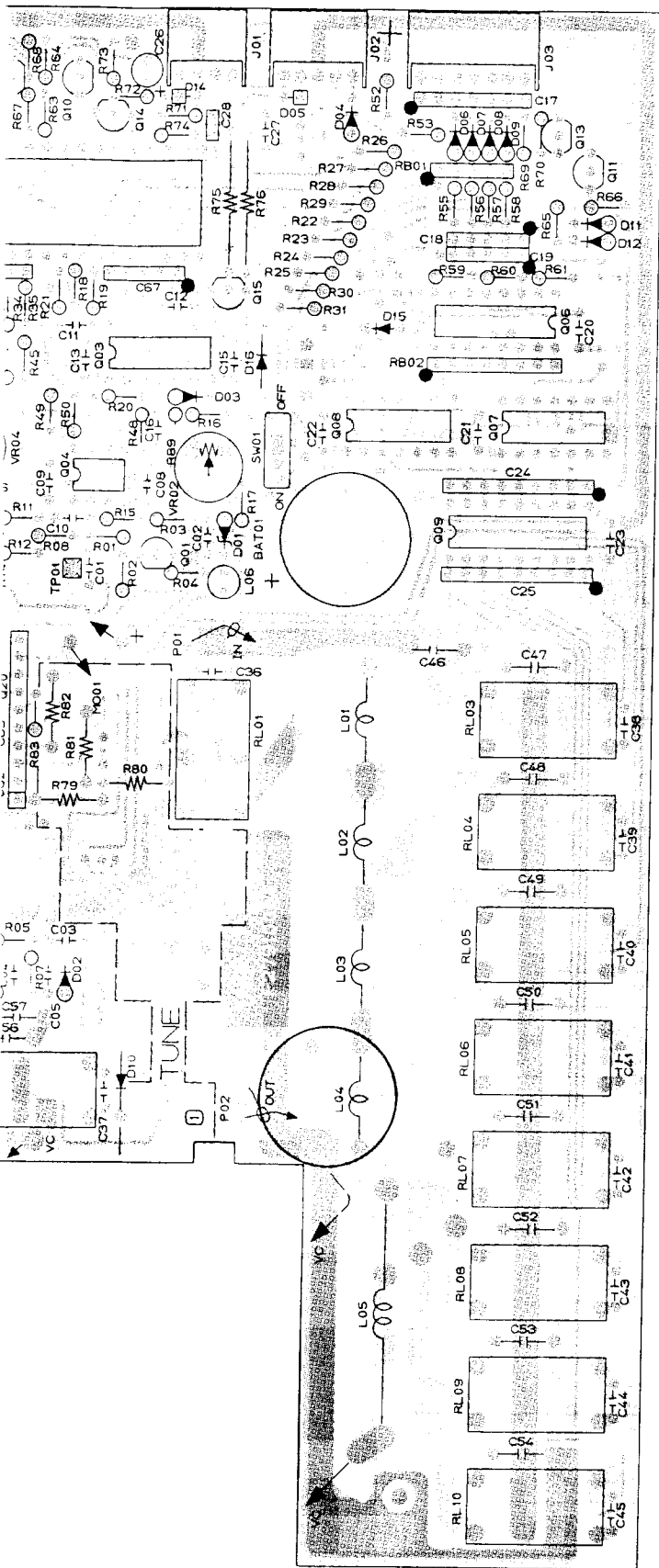

(Viewed from Solder side)

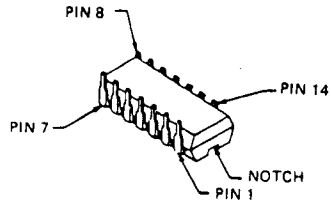

MC14066BCP (Q5003)
MC14071BCP (Q5007,Q5008)

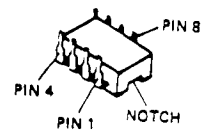

μPC277C (Q5004)

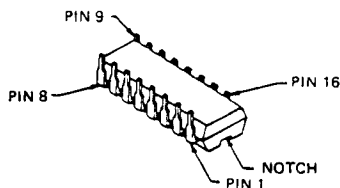

MC14028BCP (Q5006)

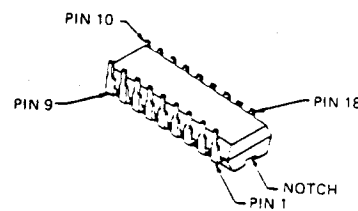

M54563P (Q5009)

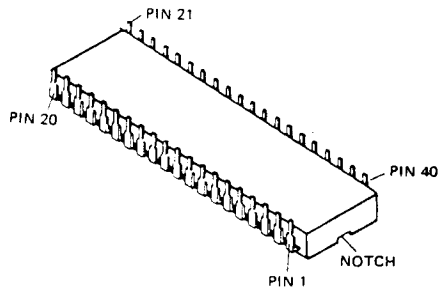

μPD7507C-070 (Q5005)

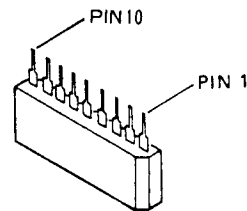

TH3C10 (Q5020,Q5021)

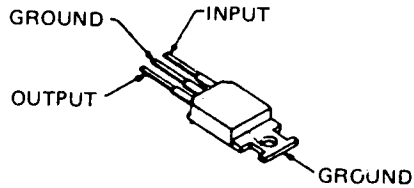

μPC7808H (Q5022)

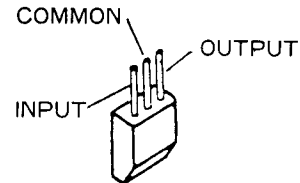

μPC78L05 (Q5023)

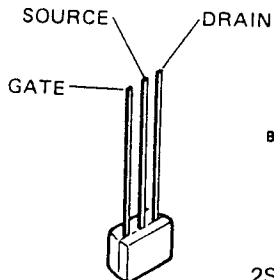

2SK152-3 (Q5001) (Q5002,Q5010,Q5015)

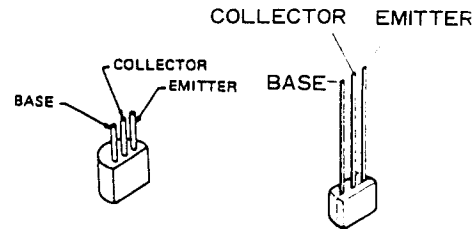

2SC458B

BA1A4M (Q5016-5019)

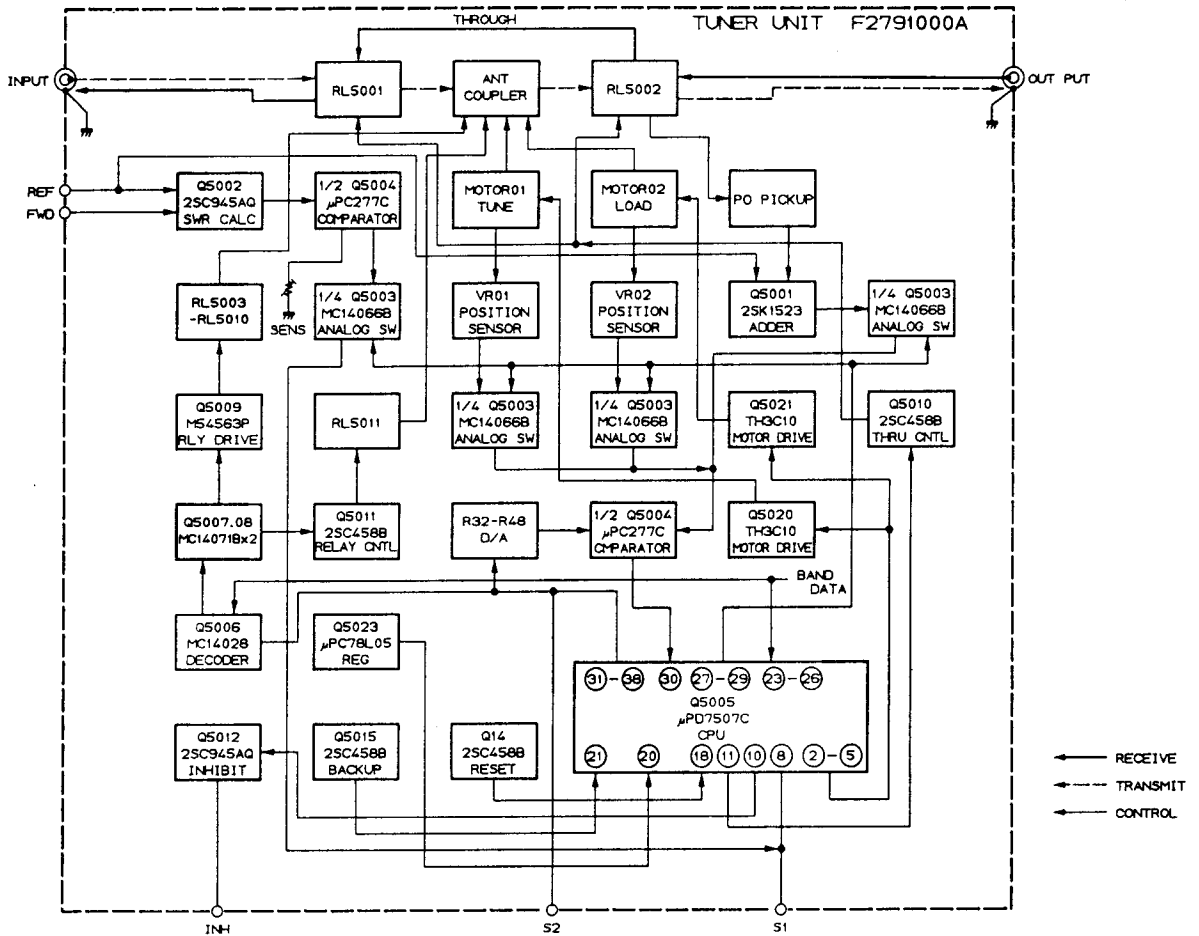

TUNER UNIT VOLTAGE CHART (DC VOLTS)

	E (S)		C (D)		B (G _i)		REMARKS
	R	T	R	T	R	T	
Q5001	0	0	0	0	0	0	
Q5002	0	0	0	0	0.3	0.3	
Q5010	0	0	0.2	0.2	0.8	0.8	TUNER ON
Q5011	0	0	0	0	0.8	0.8	3.5MHz
Q5012	0	0	4.5	4.5	0	0	
Q5013	0	0	0	0	0.7	0.7	1MHz(TRV)
Q5014	0	0	0	0	0.6	0.6	
Q5015	2.0	2.0	2.0	2.0	2.6	2.6	
Q5016	0	0	0	0	0	0	
Q5017	0	0	0	0	0	0	
Q5018	0	0	0	0	0	0	
Q5019	0	0	0	0	0	0	

TUNER UNIT IC VOLTAGE CHART (DC VOLTS)

PIN No.	1	2	3	4	5	6	7	8	9	10	11	12	13	14	15	16
Q5003	-	-	-	-	-	0	-	-	-	-	-	-	-	5.0		
Q5004	-	-	-	0	-	-	-	13.3								
Q5006	-	-	-	-	-	-	-	0	-	-	-	-	-	-	-	5.0
Q5007	-	-	-	-	-	-	0	-	-	-	-	-	-	5.0		
Q5008	-	-	-	-	-	-	0	-	-	-	-	-	-	5.0		
Q5009	-	-	-	-	-	-	-	-	11.4	0						
Q5020	0	-	-	-	-	-	-	-	-	8.0						
Q5021	0	-	-	-	-	-	-	-	-	8.0						

TUNER UNIT CIRCUIT DIAGRAM

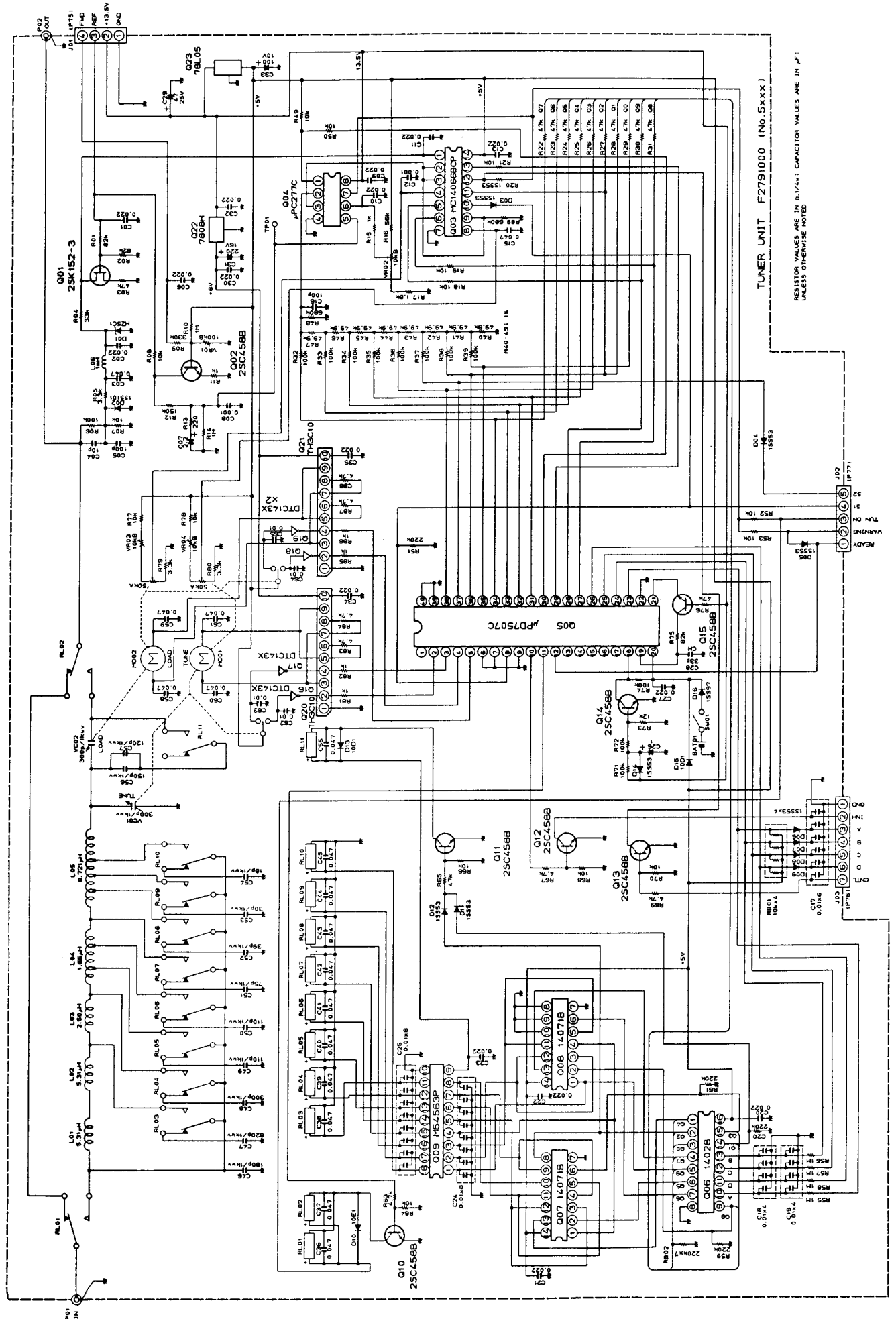

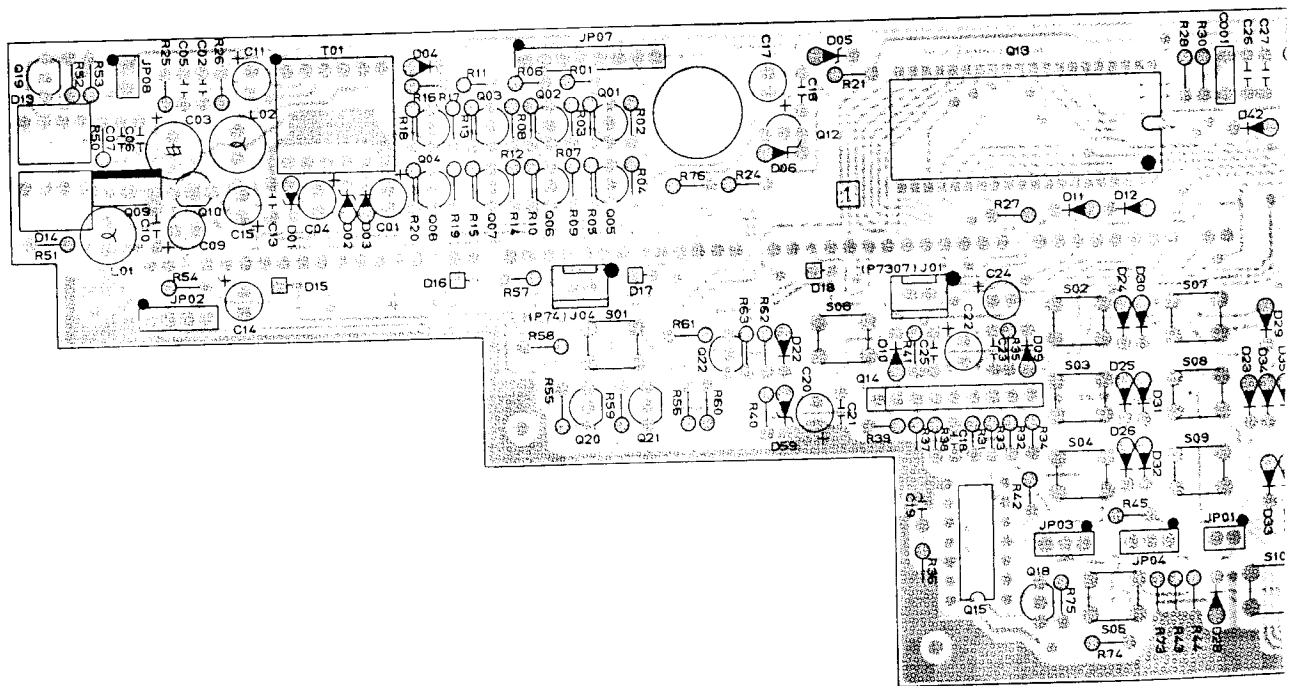
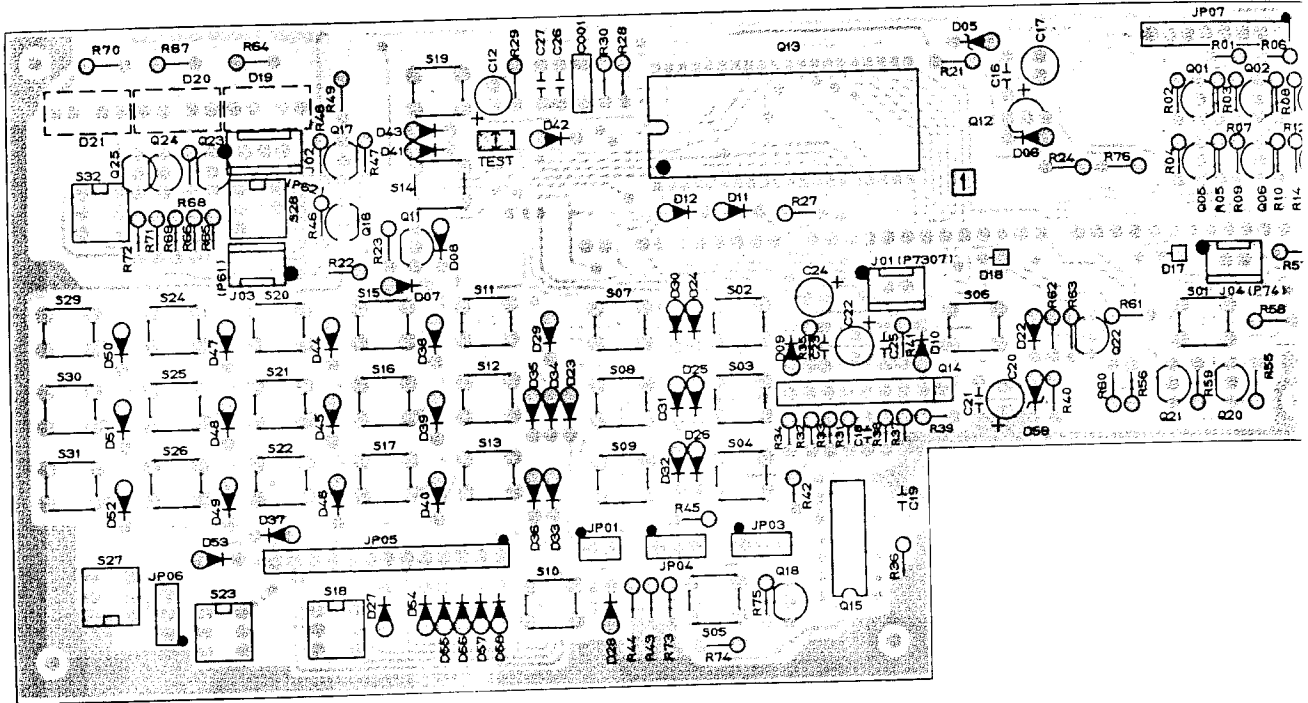

DISPLAY UNIT PARTS LAYOUT

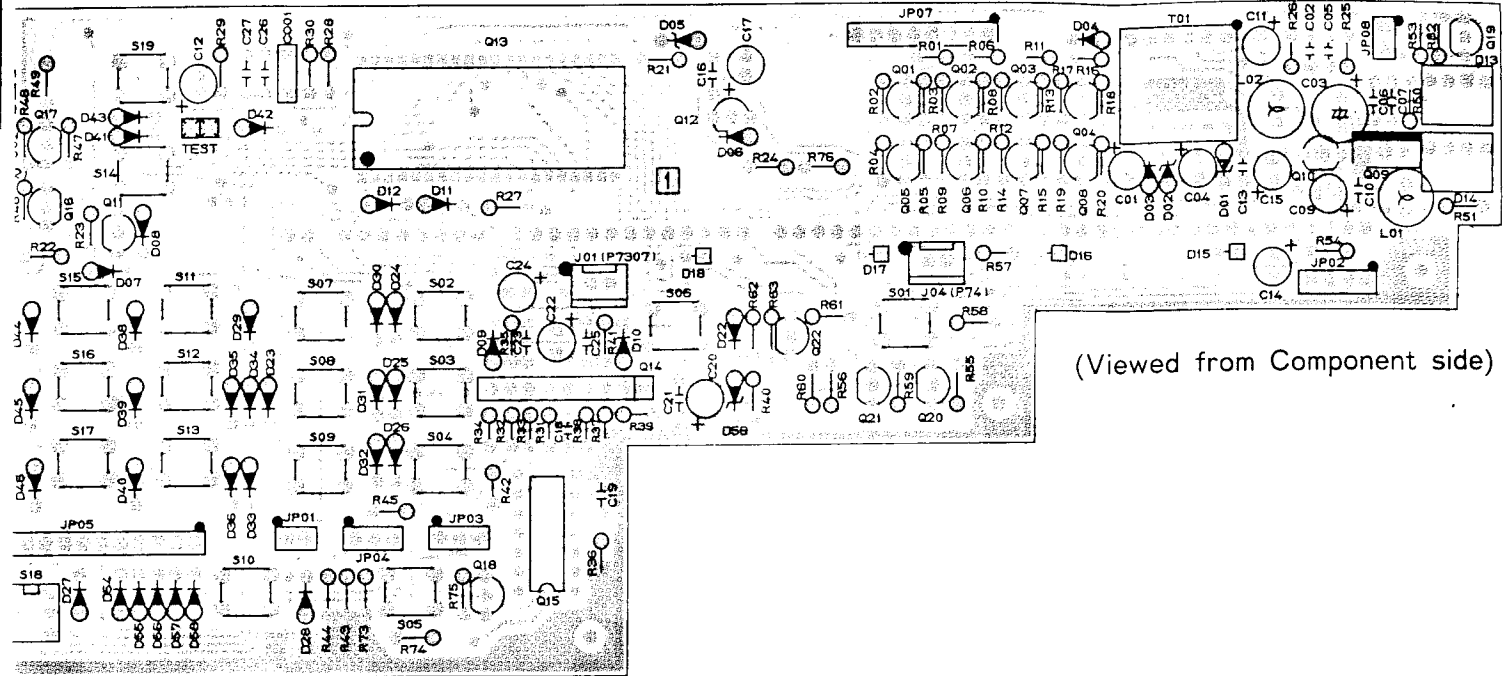

(Viewed from Component side)

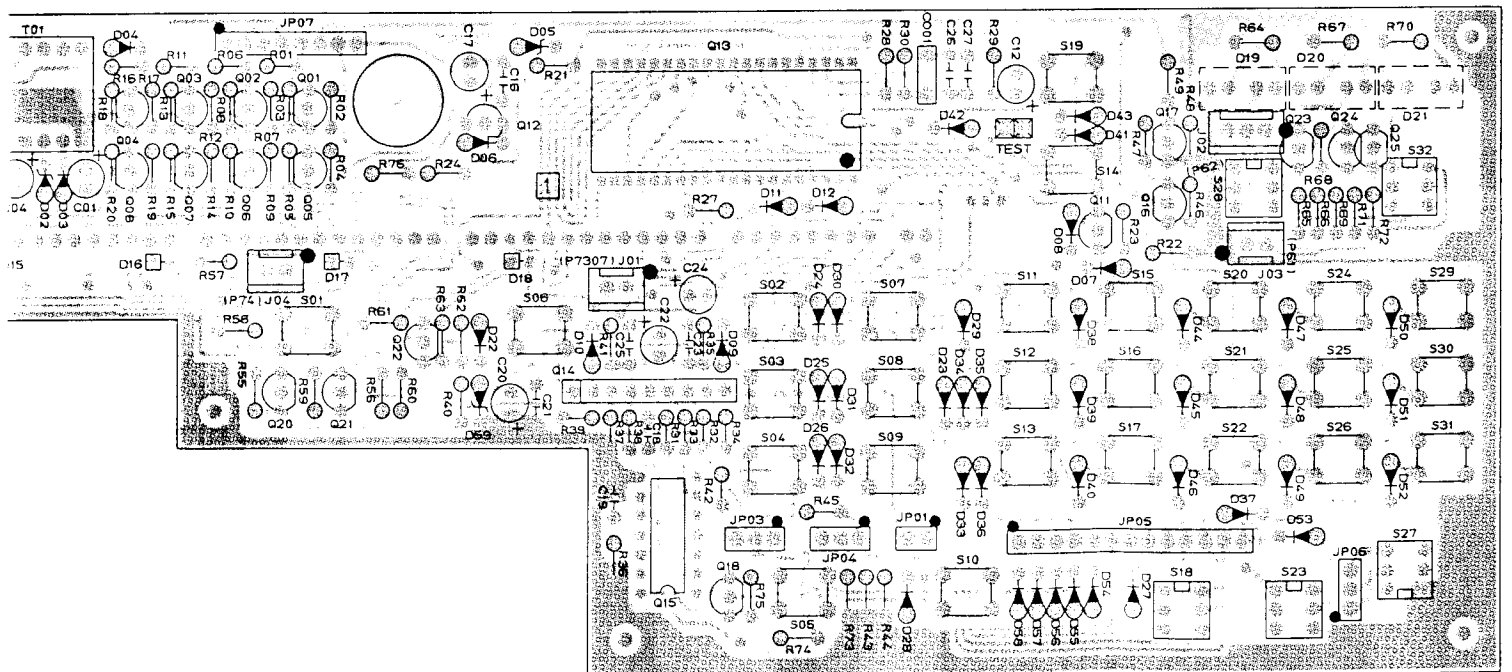

(Viewed from Solder side)

UNIT PARTS LAYOUT

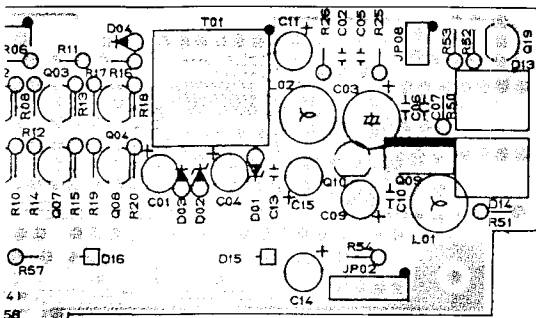

(Viewed from Component side)

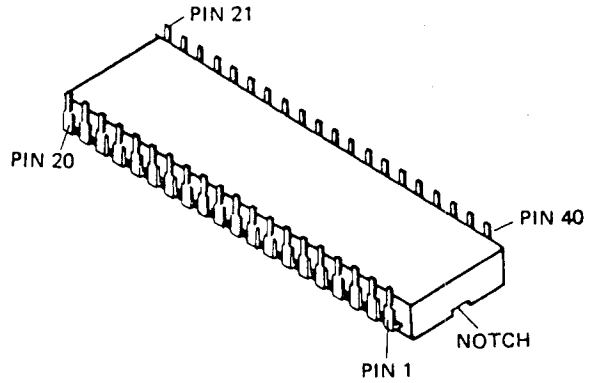

TMS2370 (Q7013)

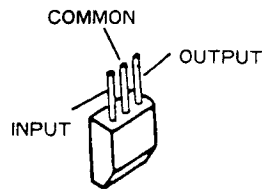

μPC78L05 (Q7010)

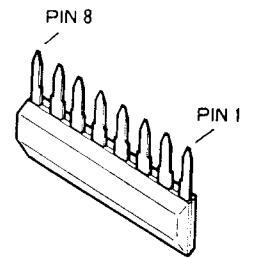

M5218L (Q7014)

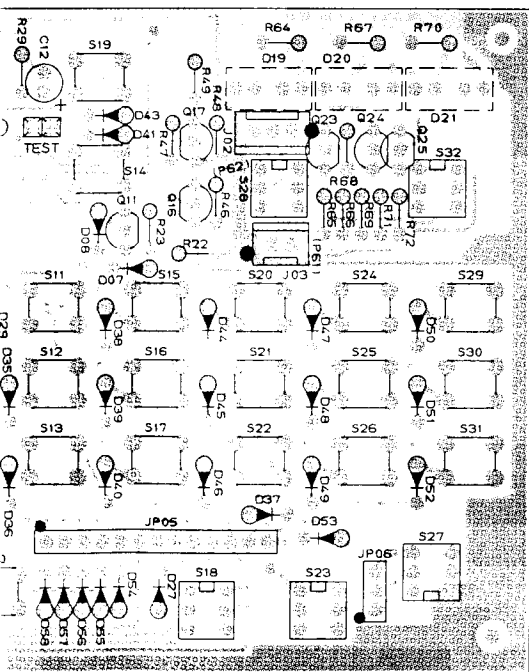

(Viewed from Solder side)

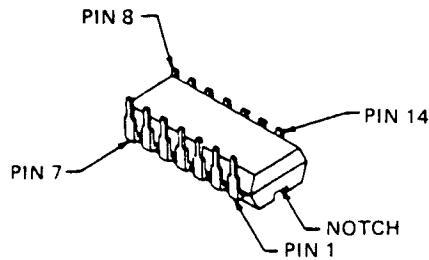

MC14066BCP (Q7015)

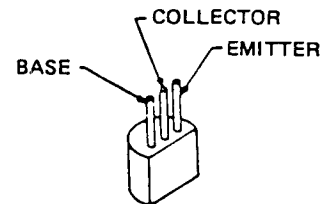

2SA733AP
(Q7005-7008,7011
7012,7016,7018)

2SC458B
(Q7001-7004,7017
7019-7025)

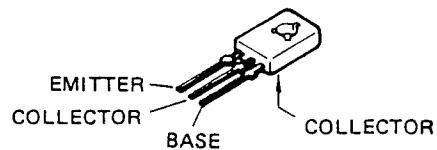

2SC496Y (Q7009)

DISPLAY UNIT VOLTAGE CHART (DC VOLTS)

	E (S)		C (D)		B (G _i)		REMARKS
	R	T	R	T	R	T	
Q7001	0	0	0	0	0.7	0.7	430MHz
Q7002	0	0	0	0	0.7	0.7	"050"MHz
Q7003	0	0	0	0	0.7	0.7	430MHz
Q7004	0	0	0	0	0.7	0.7	430MHz
Q7005	5.0	5.0	5.0	5.0	4.5	4.5	430MHz
Q7006	5.0	5.0	5.0	5.0	4.5	4.5	"050"MHz
Q7007	5.0	5.0	5.0	5.0	4.5	4.5	430MHz
Q7008	5.0	5.0	5.0	5.0	4.5	4.5	430MHz
Q7009	0	0	AC	AC	AC	AC	DC-DC
Q7011	0	0	-27.0	-27.0	0	0	
Q7012	5.0	5.0	-3.5	-3.5	5.0	5.0	
Q7016	5.0	5.0	5.0	5.0	4.4	4.4	TONE ON
Q7017	0	0	0	0	0.7	0.7	TONE ON
Q7018	5.0	5.0	5.0	5.0	4.4	4.4	TRV
Q7019	0	0	0	0	0.7	0.7	BUSY LED ON
Q7020	0	0	0	0	0.7	0.7	CAT LED ON
Q7021	0	0	0	0	0.7	0.7	TRACK LED ON
Q7022	0	0	0	0	0.7	0.7	GEN LED OFF
Q7023	0	0	0	0	0.7	0.7	READY LED ON
Q7024	0	0	0	0	0.7	0.7	WAIT LED ON
Q7025	0	0	0	0	0.7	0.7	WARN LED ON
Q01	0		0		0.8		VRC

DISPLAY UNIT IC VOLTAGE CHART (DC VOLTS)

PIN No.	1	2	3	4	5	6	7	8	9	10	11	12	13	14
Q7014	0	0	0	-4.9	0	0	0	5.0						
Q7015	0	0	0	0	0	0	0	0	0	0	0	2.3	2.3	5.0

DISPLAY UNIT CIRCUIT DIAGRAM

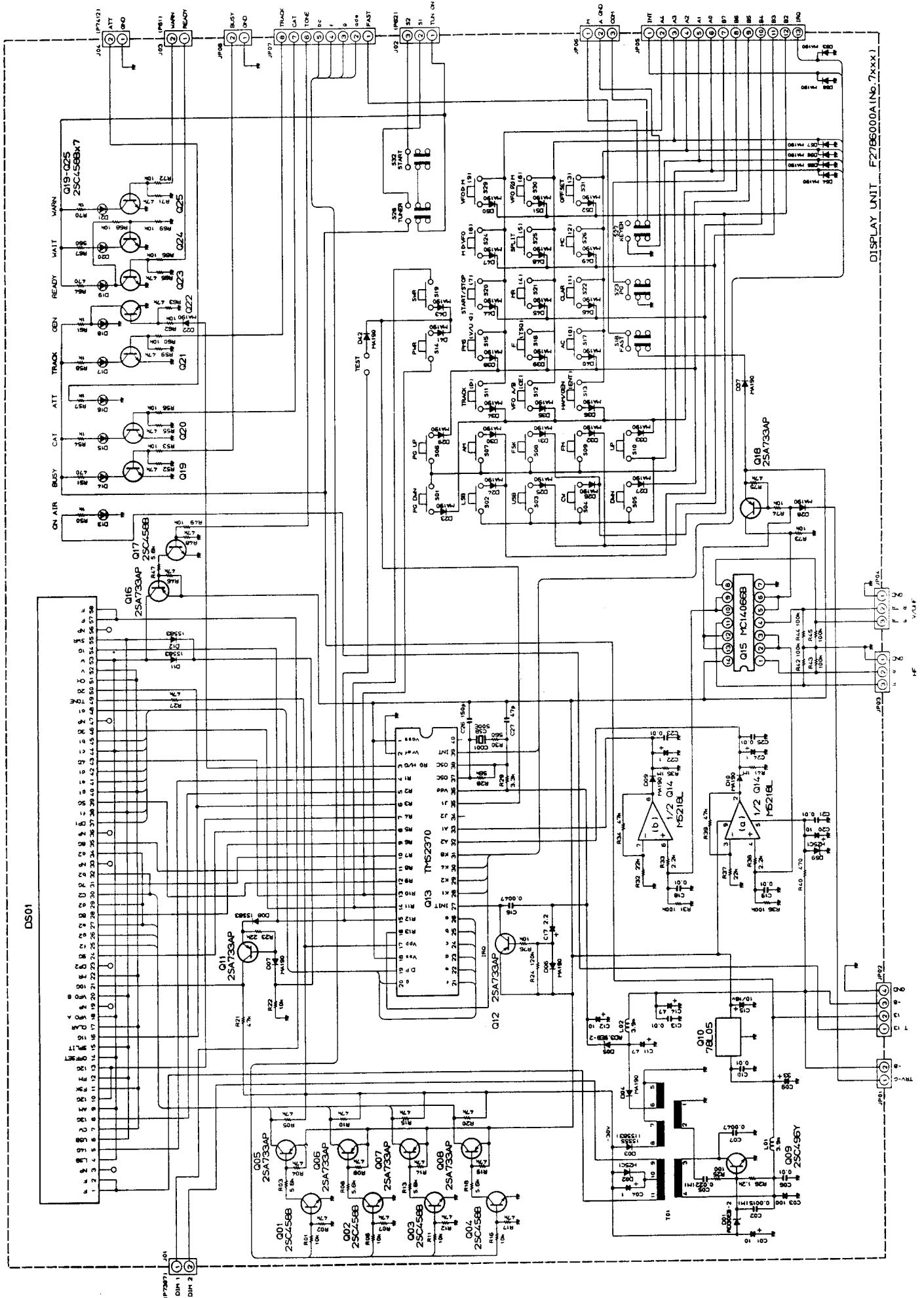

CONTROL UNIT PARTS LAYOUT

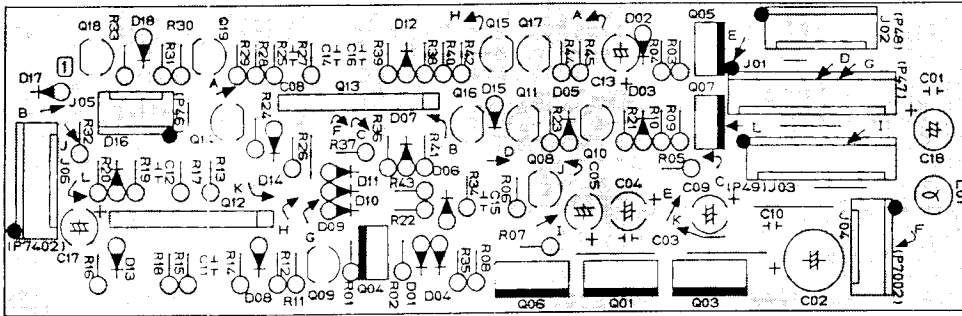

(Viewed from component side)

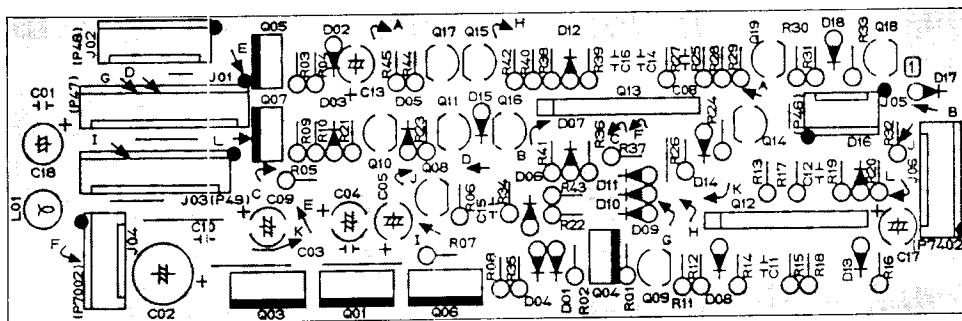

(Viewed from solder side)

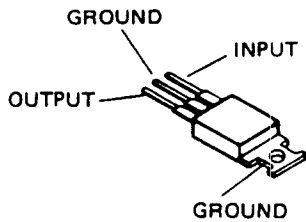

TA78009AP (Q4001)
 μ PC7808H (Q4003)

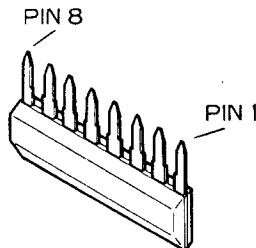

M5218L
 (Q4012,4013)

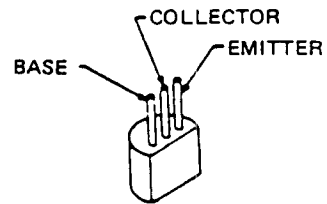

2SA733AP
 (Q4015,4019)
 2SC945AQ
 (Q4008-4011,4014)
 4016-4018

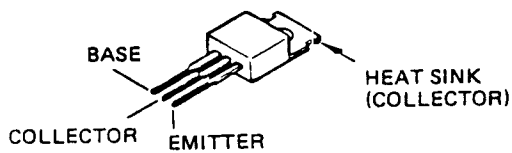

2SA1012Y (Q4006)

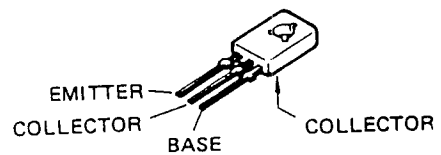

2SC496Y
 (Q4004,4005,4007)

CONTROL UNIT VOLTAGE CHART (DC VOLTS)

	E	(S)	C	(D)	B	(G ₁)	REMARKS
	R	T	R	T	R	T	
Q4004	8.0	8.0	0	8.0	8.0	7.3	
Q4005	8.0	8.0	8.0	0	7.3	8.0	
Q4006	13.2	13.2	0	13.0	13.2	12.4	
Q4007	13.2	13.0	0	13.0	13.2	12.4	
Q4008	0	0	0	0	0.6	0.6	TRV
Q4009	0	0	12.7	0	0	0.7	
Q4010	0.8	0	0	12.7	1.5	0	
Q4011	0	0	1.5	0	0	0.7	
Q4014	0	0	0	0.8	0	0	
Q4015	0	8.0	0	8.0	0	7.2	
Q4016	0	0.8	0	0.8	0	1.5	
Q4017	0	0	0	1.5	0	0	
Q4018	0	0.7	0	0.7	0	1.4	
Q4019	8.0	8.0	8.0	8.0	7.3	7.3	CW SEMI KEY DWN

CONTROL UNIT IC VOLTAGE CHART (DC VOLTS)

PIN No.		1	2	3	4	5	6	7	8	REMARKS
Q4012	RX	-6.0	7.5	4.0	-7.4	0	3.24	-6.0	8.0	
	TX	7.1	0	4.0	-7.4	6.3	3.24	7.1	8.0	
Q4013	RX	-6.0	4.0	0	-7.4	0	4.0	-6.0	8.0	CW SEMI KEY DWN
	TX	7.2	4.0	8.0	-7.4	7.6	4.0	7.5	8.0	

CONTROL UNIT CIRCUIT DIAGRAM

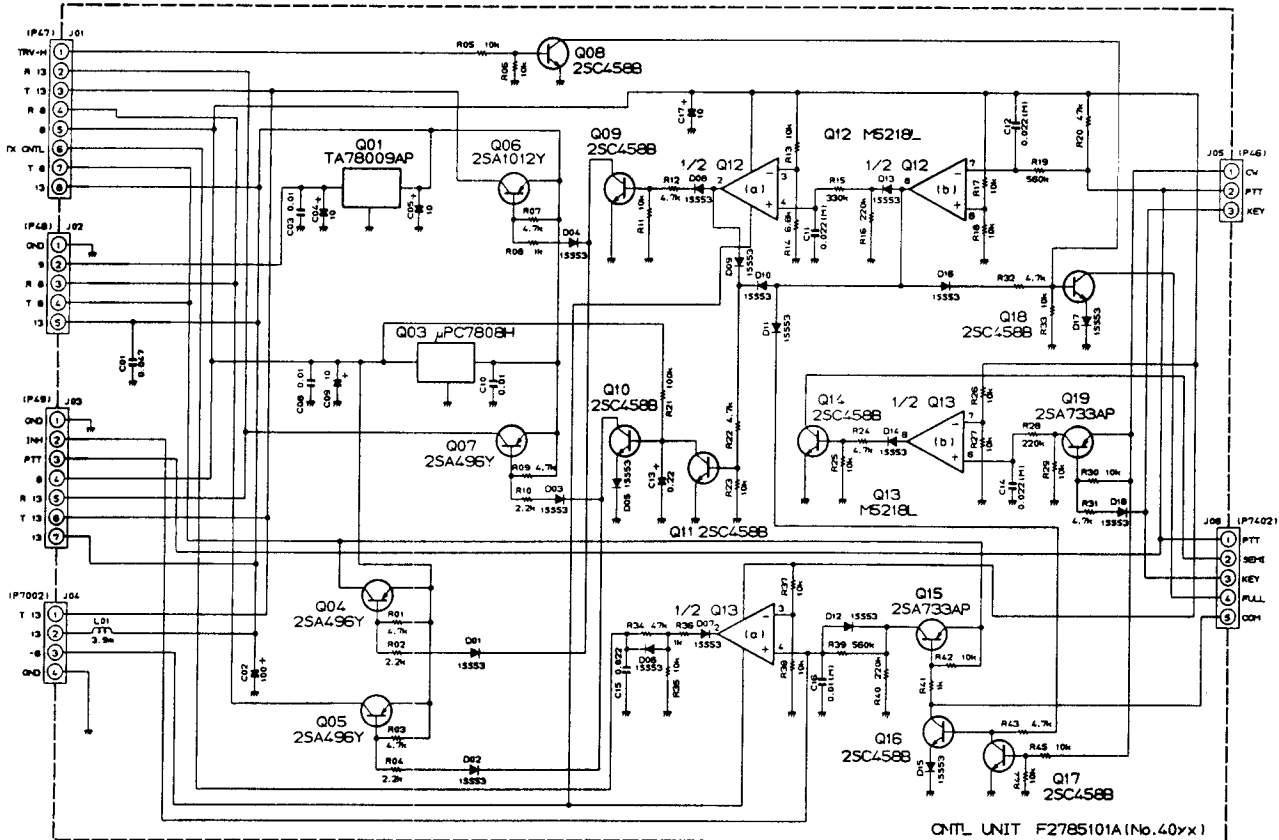

RESISTOR VALUES ARE IN Ω, 1/4W; CAPACITOR VALUES ARE IN μF;
AND INDUCTOR VALUES ARE IN mH UNLESS OTHERWISE NOTED.
1H1 CAPACITORS ARE POLYESTER FILM 50V.

SW A UNIT PARTS LAYOUT

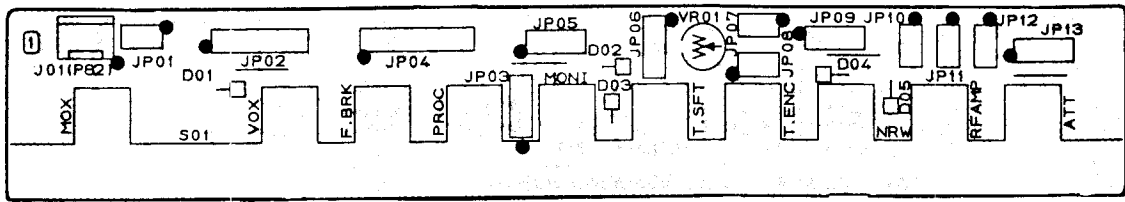

(Viewed from Component side)

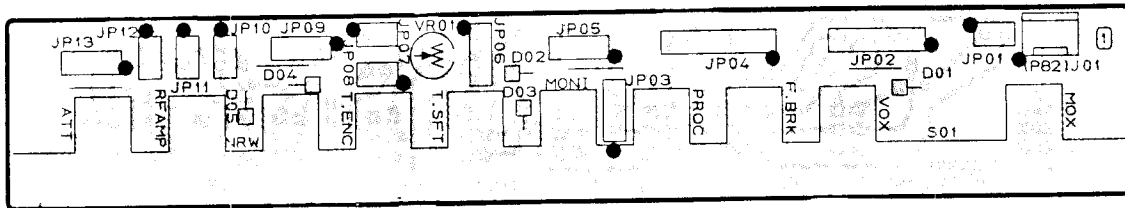

(Viewed from Solder side)

SW B UNIT PARTS LAYOUT

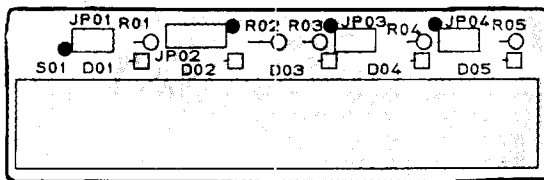

(Viewed from Component side)

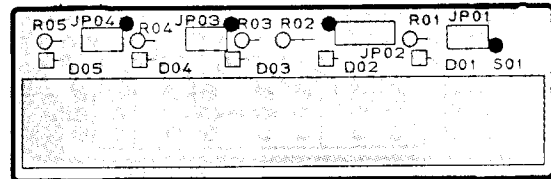

(Viewed from Solder side)

SW C UNIT PARTS LAYOUT

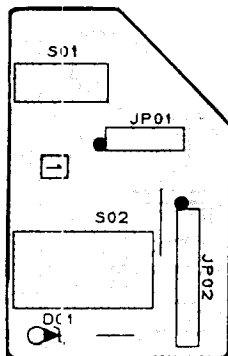

(Viewed from Component side)

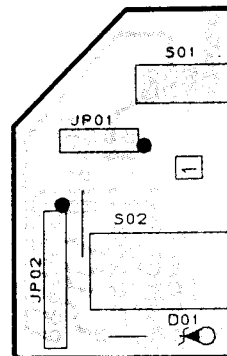

(Viewed from Solder side)

See page 19 for Schematic Diagrams of these Units.

SW A UNIT PARTS LAYOUT

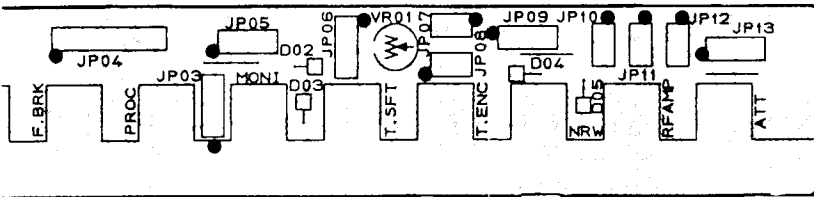

(Viewed from Component side)

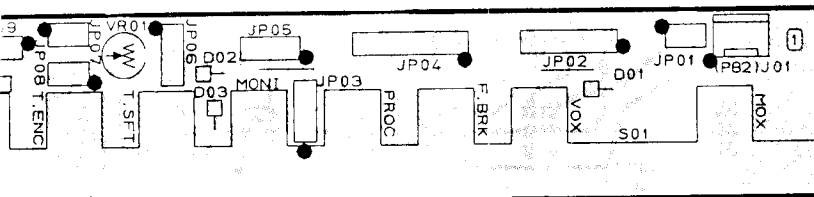

(Viewed from Solder side)

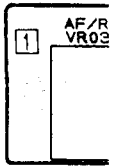

SW B UNIT PARTS LAYOUT

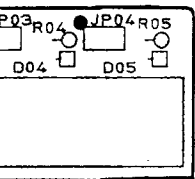

(Viewed from Component side)

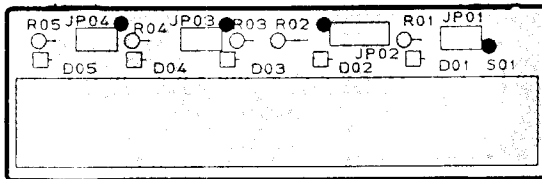

(Viewed from Solder side)

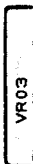

SW C UNIT PARTS LAYOUT



(Viewed from Component side)

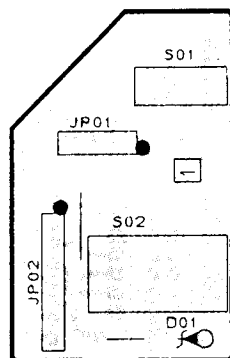

(Viewed from Solder side)

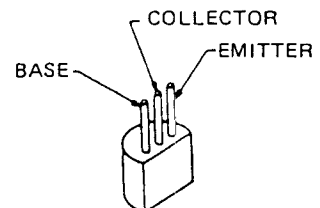

2SC1959Y (Q7301)

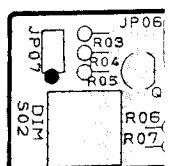
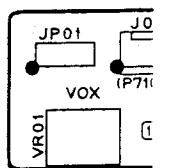

Schematic Diagrams of these Units.

VR A UNIT PARTS LAYOUT

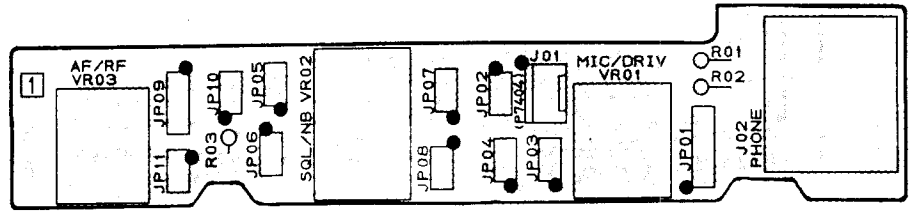

(Viewed from Component side)

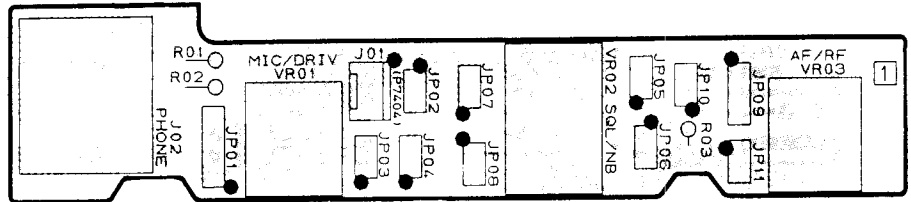

(Viewed from Solder side)

VR B UNIT PARTS LAYOUT

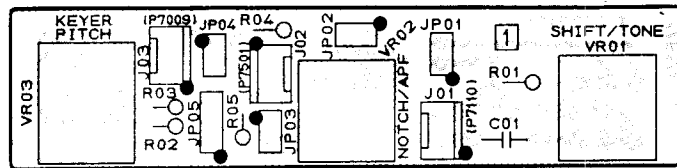

(Viewed from Component side)

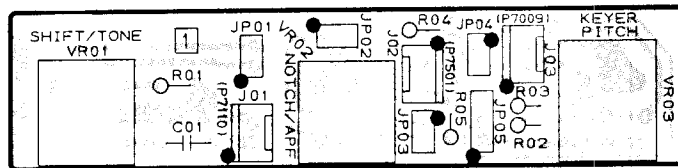

(Viewed from Solder side)

VR C UNIT PARTS LAYOUT

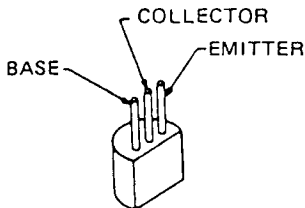

2SC1959Y (Q7301)

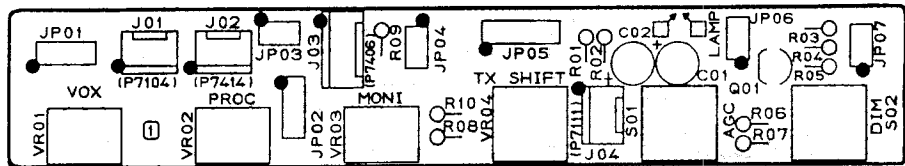

(Viewed from Component side)

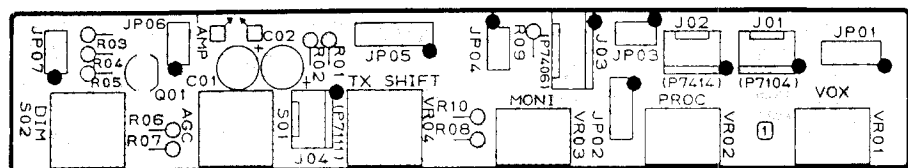

(Viewed from Solder side)

TRV CNTL UNIT PARTS LAYOUT

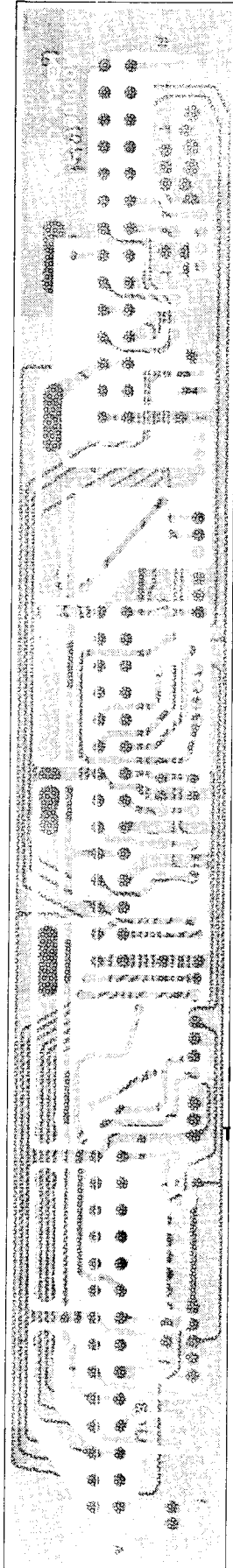

(Viewed from Component side)

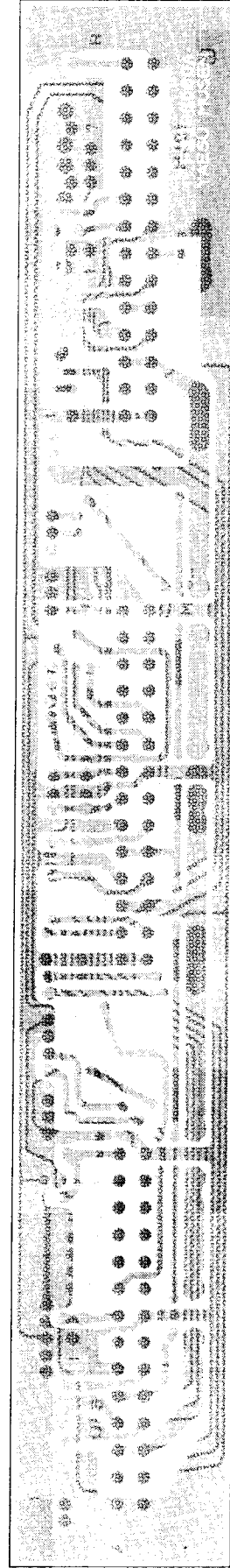

(Viewed from Solder side)

TRV CNTL UNIT CIRCUIT DIAGRAM

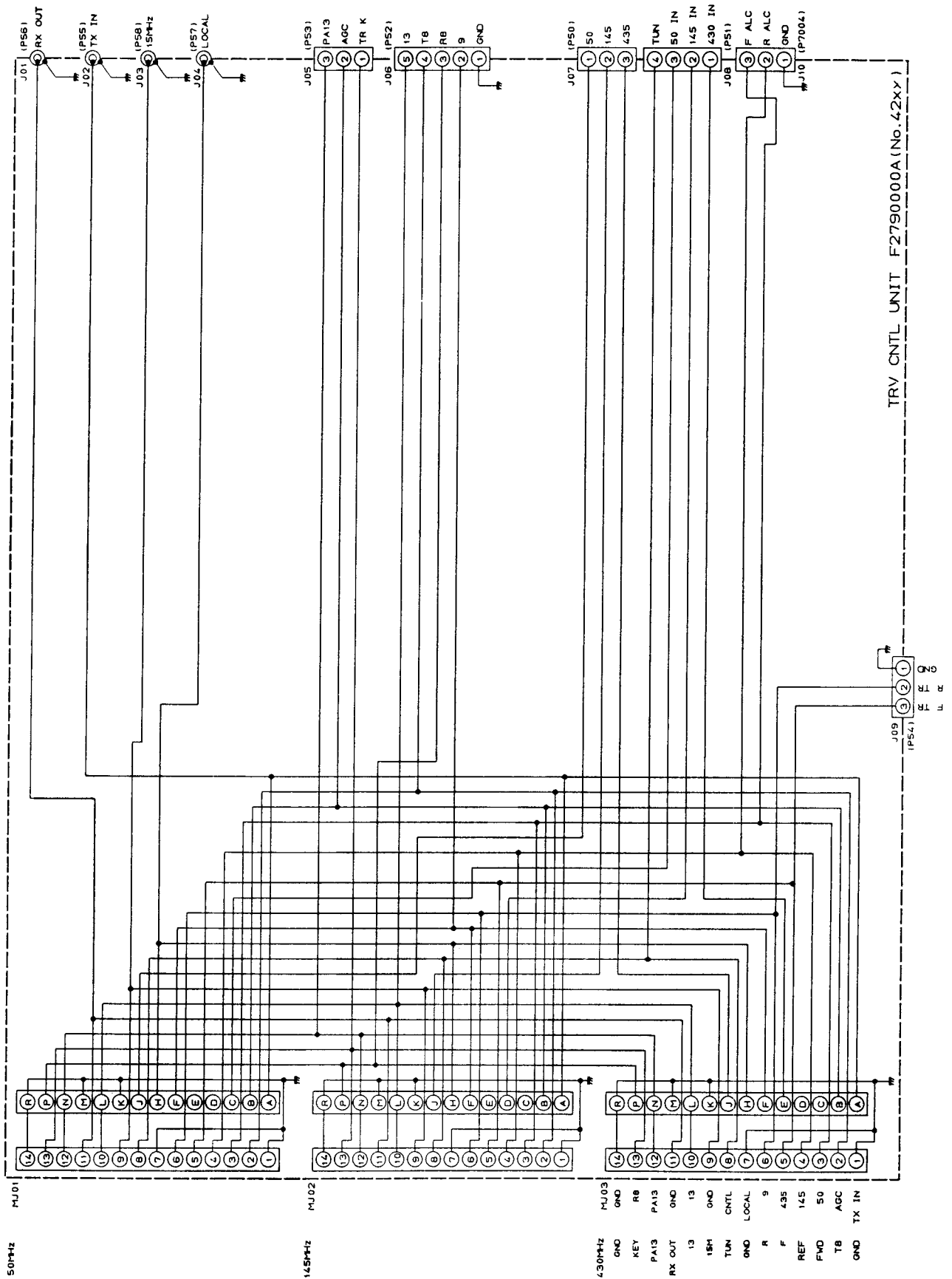

FEX-767-6 6m BAND MODULE

6m LOCAL UNIT

All measurements and adjustments are to be made while receiving unless otherwise stated.

(1) VCV (Varactor Control Voltage)

Tune to 50.5 MHz, and connect the high impedance DC voltmeter to TP2002. Adjust VR2001, if necessary, for $2.0 \pm 0.2V$.

(2) 30 MHz Doubler

Tune the transceiver to 52.0 MHz. Connect the RF voltmeter to TP2001 and adjust T2007 and T2006 for maximum RF (at least 80 mVrms).

(3) Local Output Filters

Tune the transceiver to 51.5 MHz. Connect the RF voltmeter to pin 3 of J2001 and adjust T2001 through T2005 for maximum RF (at least 600 mVrms).

6m RECEIVING CONVERTER

(1) 6m Front End

Tune the transceiver to 50.5 MHz, USB mode. Inject a 60 dBu carrier at the receiving frequency to the 6m ANT jack and adjust T1013, T1008, T1007, T1006 and T1005 for maximum S-meter deflection.

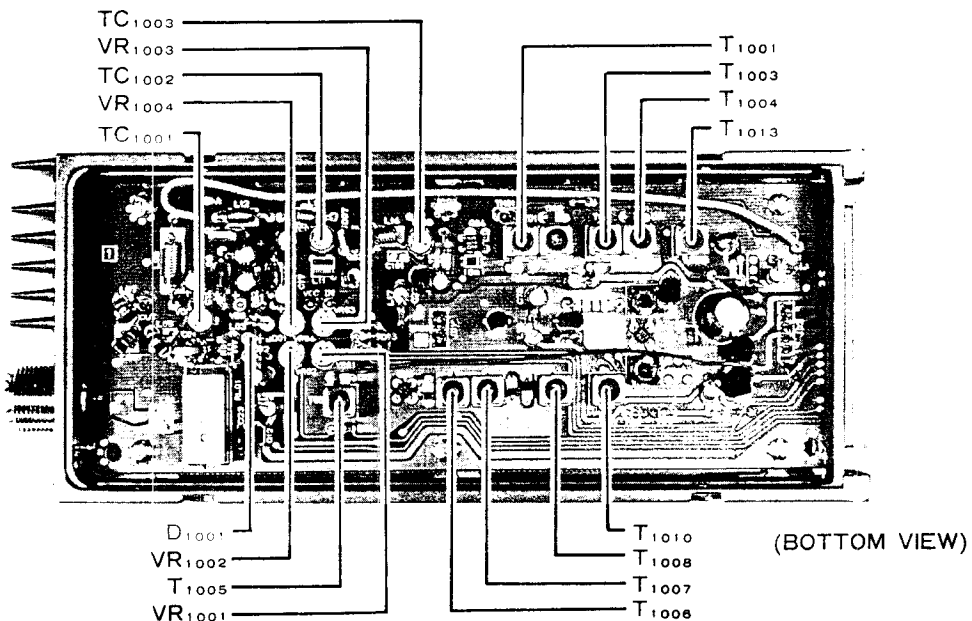
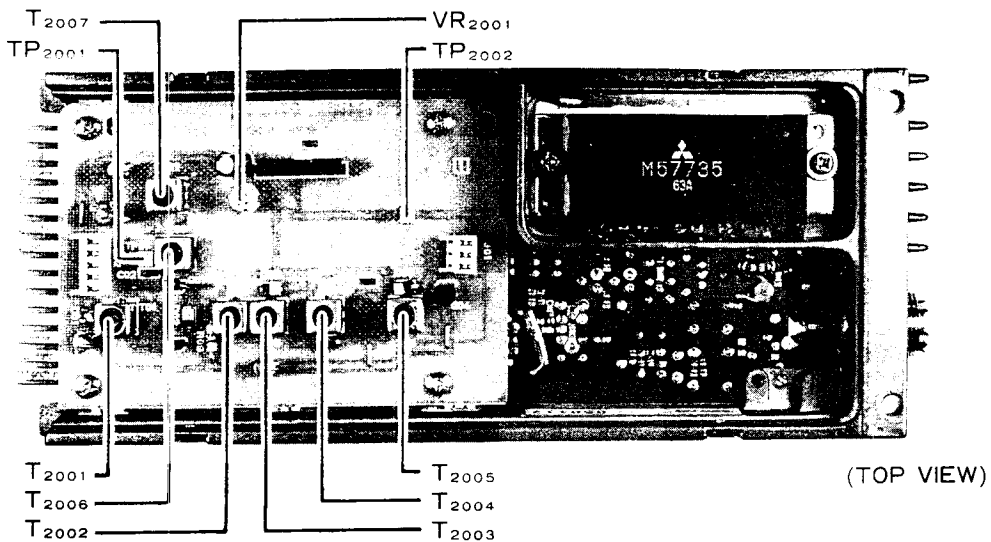

FEX-767-6 Alignment Points

(2) 45 MHz Trap Coil

After the above step, retune the RF signal generator to 45.03 MHz and inject 90 dBu to the 6m ANT jack. Adjust T1010 for minimum S-meter deflection, and then repeat the previous step to realign T1008.

6M TRANSMITTING CONVERTER

Connect a 50-ohm dummy load and in-line wattmeter to the 6m ANT jack for all steps, except where indicated otherwise. Press the MOX button for all measurements.

(1) 6m Resonant Circuits

Tune the transceiver to 50.5 MHz, FM mode, and set the METER selector to ALC and the DRIVE control to the center of its range. Press the MOX button and adjust T1001 and T1004 for maximum ALC indication.

Retune to 51.8 MHz, press the MOX button and adjust T1002 and T1003 for maximum ALC indication. Now retune to 51.5 MHz, press the MOX button and adjust TC1003 and TC1002 for maximum ALC indication.

(2) 6m Directional CM Coupler Balance

Connect the DC voltmeter to the cathode of D1001 (top end), press the MOX button and adjust TC1001 for minimum voltage.

(3) 6m ALC Level

Tune to 52.0 MHz, FM mode, and set the DRIVE control fully clockwise. Press the MOX button and adjust VR1001 for 12W on the wattmeter. Now remove the dummy load and wattmeter, press the MOX button, and adjust VR1003 for 5W on the transceiver's digital wattmeter.

(4) Digital Wattmeter and SWR Meter

Replace the dummy load and wattmeter at the 6m ANT jack. In the FM mode, press the MOX button and adjust the DRIVE control for 10W on the external wattmeter. Press the RF PWR button and MOX button adjust VR1002 for the same indication on the digital display.

Now connect a 150-ohm dummy load (3 50-ohm loads in series) to the 6m ANT jack. Press the SWR button and the MOX button, and adjust VR1004 for 3.0 on the digital display.

FEX-767-2 2m BAND MODULE

Band center for Version B is 145.0 MHz, and for Version A, 146.0 MHz. The high band edge for for Version B is 146.999 MHz, and for Version A, 147.999 MHz.

2m LOCAL UNIT

All measurements and adjustments are to be made while receiving unless otherwise stated.

(1) VCV (Varactor Control Voltage)

Tune to the high band edge, and connect the high-impedance DC voltmeter to TP2002. Adjust TC2001 for 6.5V (Version A), or 5V (Version B). Retune to 144.0 MHz and confirm 3 to 4V.

(2) 120 MHz Mixer, Loop Amplifier

Tune the transceiver to band center. Connect the oscilloscope or spectrum analyzer to TP2001 and adjust T2001 through T2005 for maximum RF (at least 250 mVrms). Caution: make

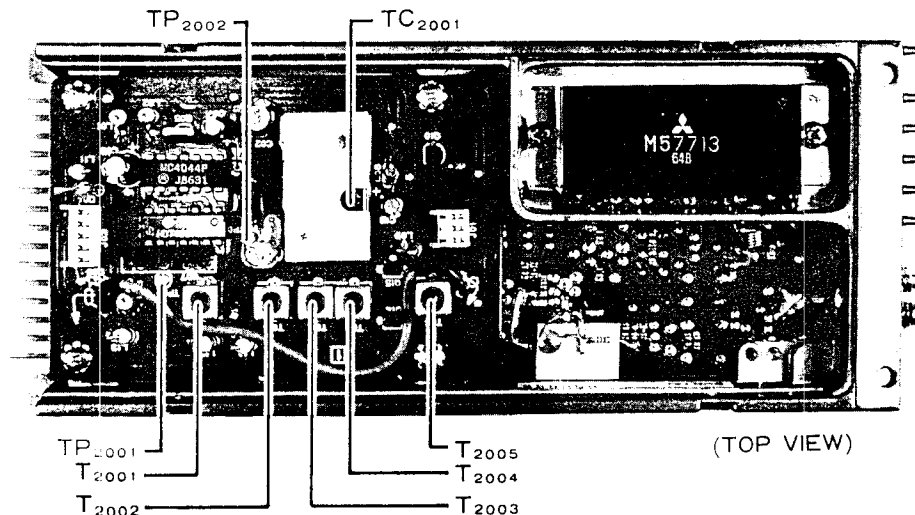

FEX-767-2 Alignment Points

sure that the signal tuned is at 120 MHz, and not a spurious mixer product.

2m RECEIVING CONVERTER

Tune the transceiver to band center, USB mode. Inject a 60 dBu carrier at the receiving frequency to the 2m ANT jack and adjust T1013, T1008, T1007, T1006 and T1005 for maximum S-meter deflection.

TRANSMITTING CONVERTER

Connect a 50-ohm dummy load and in-line wattmeter to the 2m ANT jack for all steps, except where indicated otherwise. Press the MOX button for all measurements.

(1) 2m Resonant Circuits

Tune the transceiver to band center, FM mode. Set the METER selector to ALC and DRIVE control to the center of its range. Preset VR1001 and VR1003 to mid-range. Press the MOX button and adjust T1004, T1003, T1002 and T1001 for maximum ALC indication. Perform the following two procedures to align VR1001 and VR1003.

(2) 2m Directional CM Coupler Balance

Connect the DC voltmeter to the cathode of D1001 (top end), press the MOX button and adjust TC1001 for minimum voltage.

(3) 2m ALC Level

Tune to band center, FM mode, and set the DRIVE control fully clockwise. Press the MOX button and adjust VR1001 for 12W on the wattmeter. Now replace the 50-ohm dummy load with 150 ohms. Press the MOX button and adjust VR1003 to the point where the wattmeter indication just begins to drop.

(4) Digital Wattmeter and SWR Meter

Return the 50-ohm dummy load to the 2m ANT jack. In the FM mode, press the MOX button and adjust the DRIVE control for 10W on the external wattmeter. Press the RF PWR button and adjust VR1002 for the same indication on the digital display.

Remove the dummy load and wattmeter from the 2m ANT jack. Press the SWR button and the MOX button, and adjust VR1004 for a 8 or more on the digital display. Then replace the 50-ohm load again and confirm 1.2 or less SWR on the digital display.

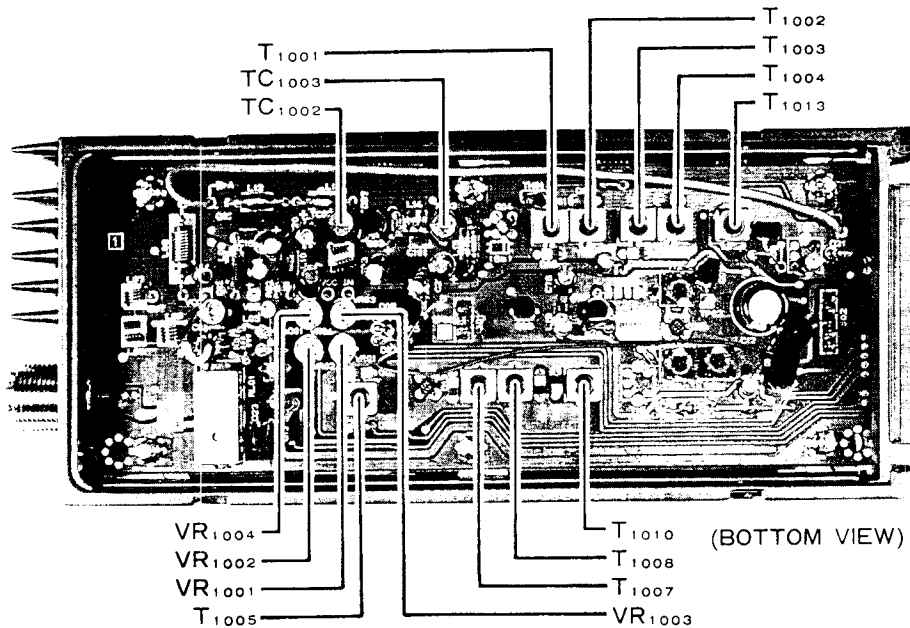

FEX-767-2 Alignment Points

FEX-767-7 70cm BAND MODULE

Band center for Version B is 435.0 MHz, and for Version A, 445.0 MHz. The high band edge for for Version B is 449.999 MHz, and for Version A, 439.999 MHz. The low band edge for Version B is 430.00 MHz, and for Version A, 440.00 MHz.

70cm PLL UNIT

All measurements and adjustments are to be made while receiving unless otherwise stated.

(1) VCV (Varactor Control Voltage)

Tune to the low band edge, and connect the high-impedance DC voltmeter to TP2001. Adjust TC2001 for 2.0V. Retune to the high band edge and confirm 4.5 to 5.5 V.

(2) Local Bandpass

Tune to band center. Connect the RF voltmeter to pin 2 of J01 and adjust both sides of CV2001 and CV2002 for maximum deflection (at least 280 mVrms).

(3) 410 MHz Loop Amplifier

Connect the RF voltmeter to the top end of R2017 and adjust both sides of CV2003 and CV2004 for maximum RF voltage. Now turn the cores 180° clockwise from the maximum position, and confirm at least 80 mVrms remains.

70cm RECEIVING CONVERTER

Tune the transceiver to band center, USB mode. Inject a 60 dBu carrier at the receiving frequency to the 70cm ANT jack and adjust TC1001 and TC1003 for maximum S-meter deflection.

Now tune the transceiver and signal generator to the high band edge and adjust CV1003(b) and CV1004(b) for maximum S-meter deflection.

Retune to 500 kHz above the low band edge and adjust CV1003(a) and CV1004(a) for maximum S-meter deflection.

Repeat adjustment of the helical resonators several times.

70cm TRANSMITTING CONVERTER

Connect a 50-ohm dummy load and in-line wattmeter to the 70cm ANT jack for all steps, except where indicated otherwise. Press the MOX button for all measurements.

(1) 70cm Resonant Circuits

Tune the transceiver to band center, FM mode, and set the METER selector to ALC and the DRIVE control to the center of its range. Pre-set VR1002 fully counterclockwise, and VR1004 to mid-range.

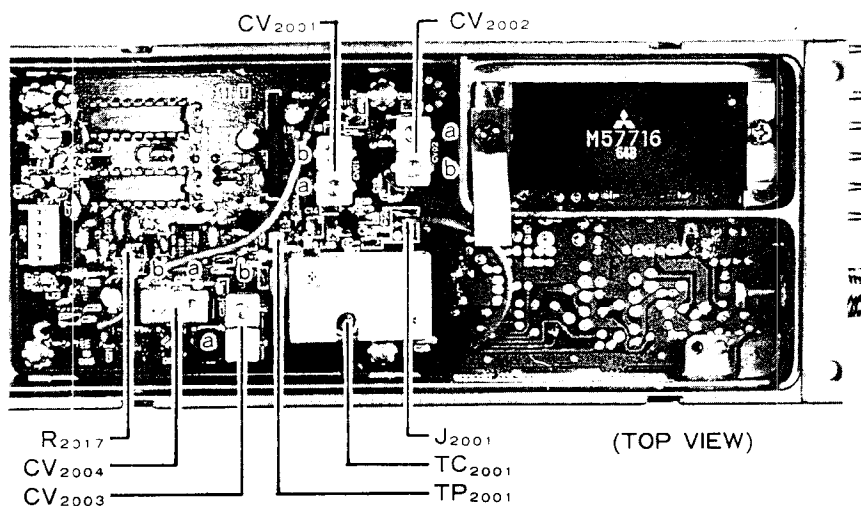

FEX-767-7 Alignment Points

Press the MOX button and adjust both sides of CV1002 and CV1001, and then TC1002 and TC1001 for maximum ALC indication.

Retune to the low band edge, press the MOX button and readjust CV1002(b) for maximum ALC. Then retune to the high band edge, press the MOX button and readjust CV1002(a) for maximum ALC. Repeat at the low and high band edges several times.

Perform the following two procedures to align VR1002 and VR1004.

(2) 70cm Directional CM Coupler Balance

Connect the DC voltmeter to the cathode of D1002 (top end), press the MOX button and adjust VR1001 for minimum voltage (less than 0.5V).

(3) 70cm ALC Level

Tune to band center, FM mode, and set the DRIVE control fully clockwise. Press the MOX button and adjust VR1004 for 12W on the wattmeter. Now replace the 50-ohm dummy load with 150 ohms. Press the MOX button and adjust VR1002 to the point where the wattmeter indication just begins to drop.

(4) Digital Wattmeter and SWR Meter

Return the 50-ohm dummy load to the 70cm ANT jack. In the FM mode, press the MOX button and adjust the DRIVE control for 10W on the external wattmeter. Press the RF PWR button and adjust VR1005 for the same indication on the digital display.

Connect the 150-ohm dummy load in place of the 50-ohm load to the 70cm ANT jack. Press the SWR button and the MOX button, and adjust VR1003 for 3.0 on the digital display.

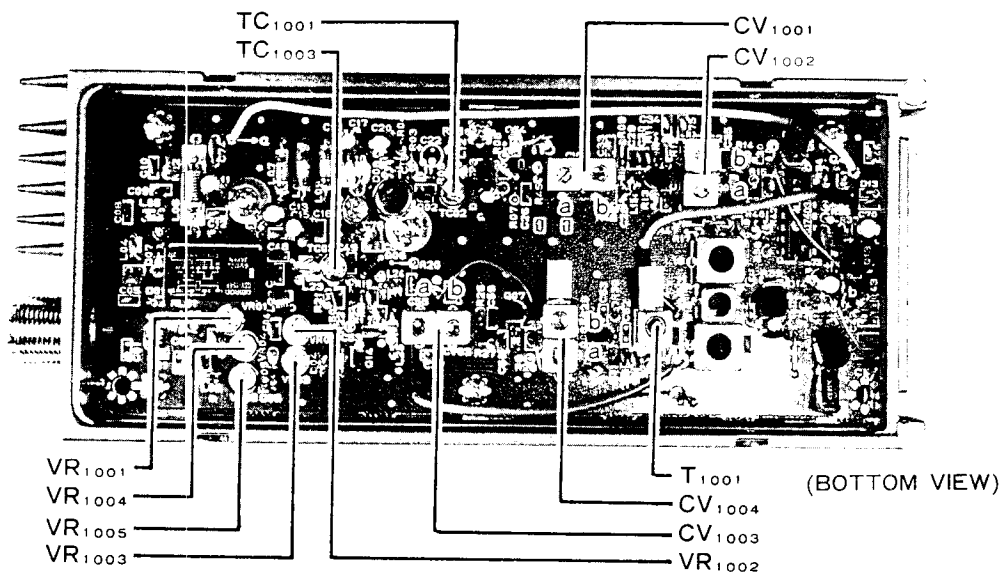

FEX-767-7 Alignment Points

MEMO

MAIN UNIT

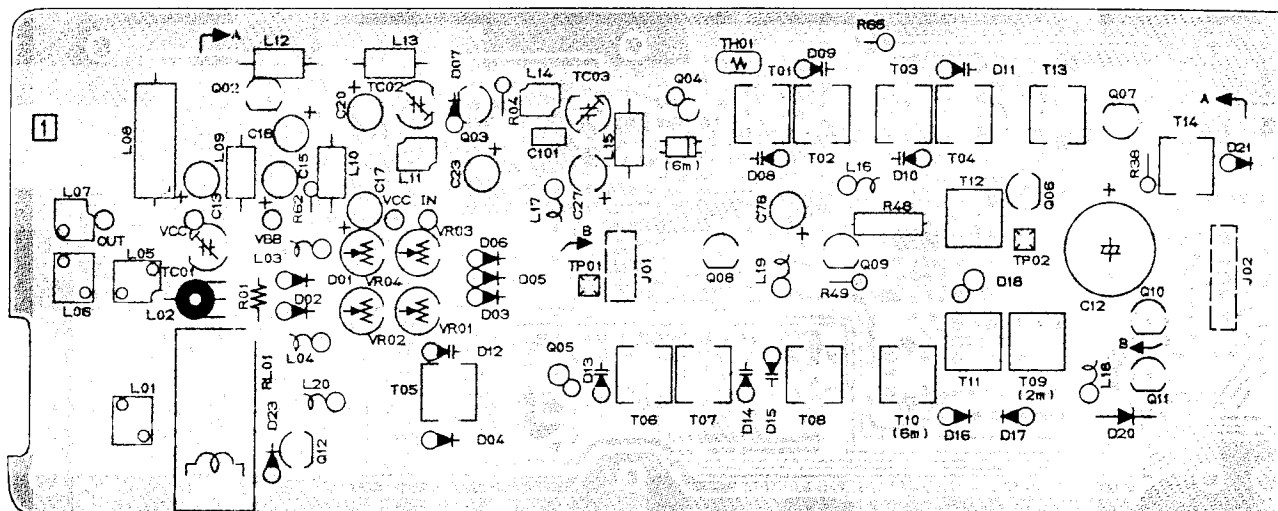

(Obverse view of "component" side)

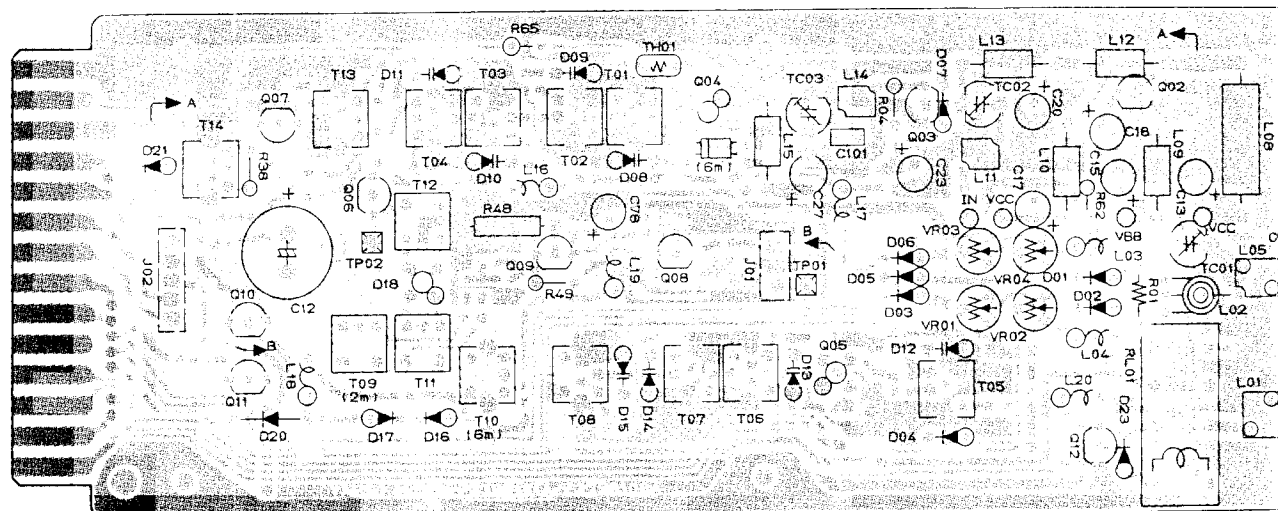

(Reverse view of "component" side)

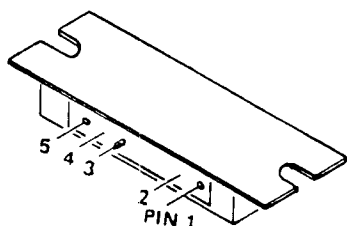

M57735 (Q1001)

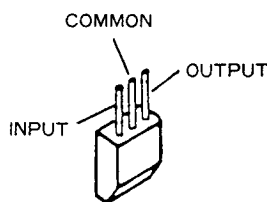

μPC78L08 (Q1002)

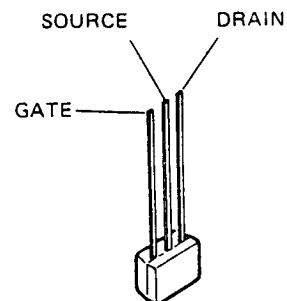

2SK241Y (Q2001,2002)

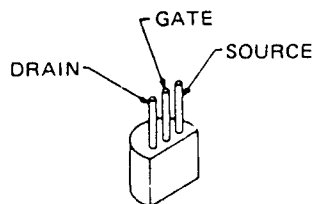

2SK125 (Q1006)

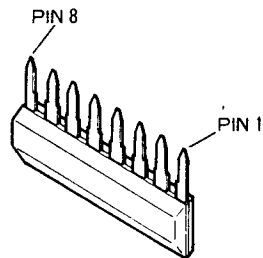

M5218L (Q2006)

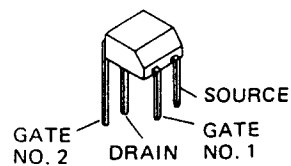

3SK73Y (Q1004)

FEX-767-6 PARTS LAYOUT

MAIN UNIT

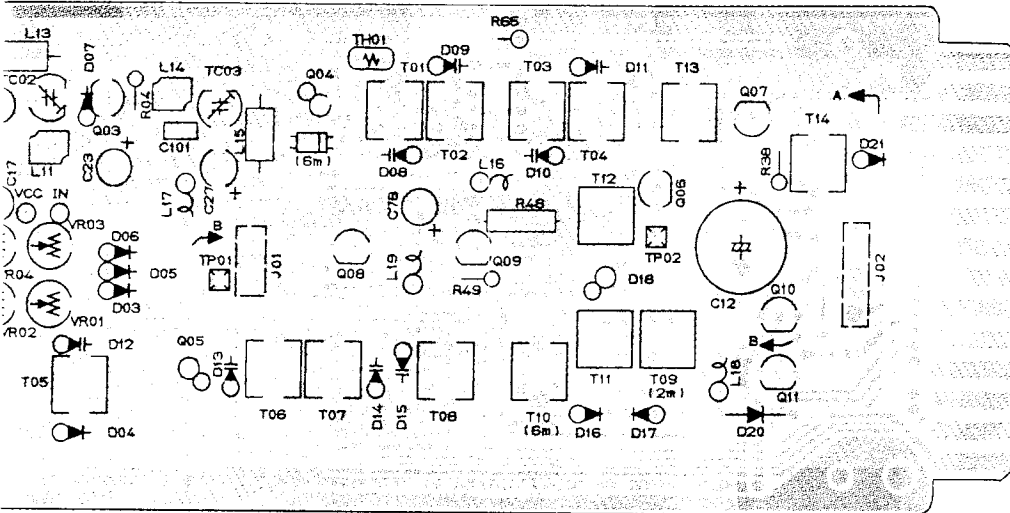

(Obverse view of "component" side)

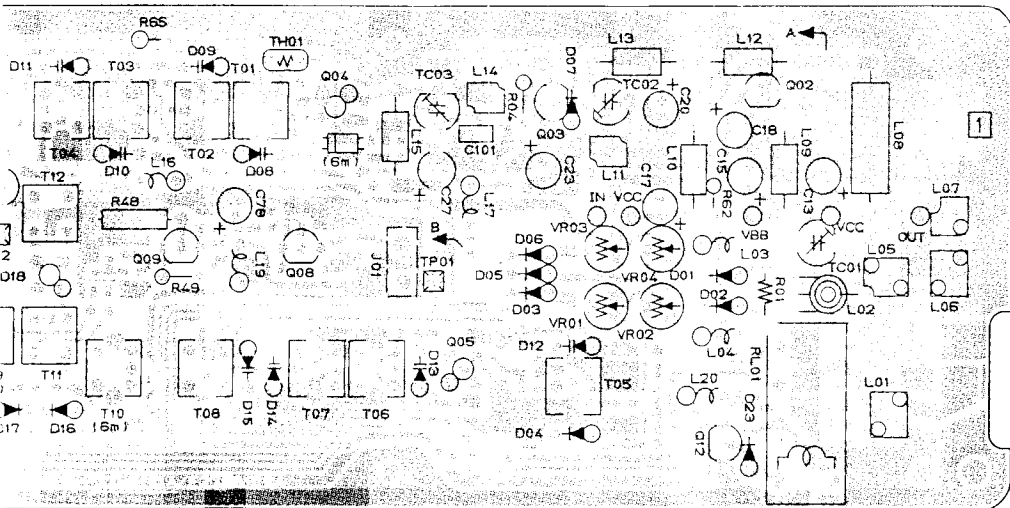
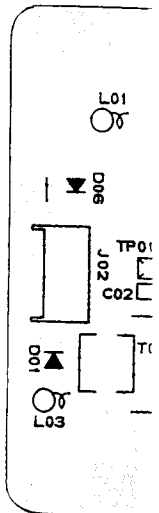

(Reverse view of "component" side)

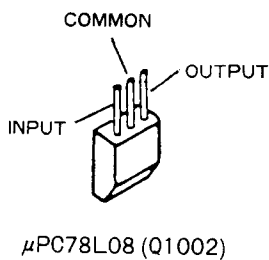
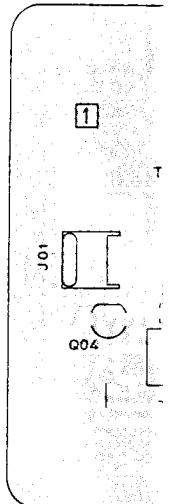

μPC78L08 (Q1002)

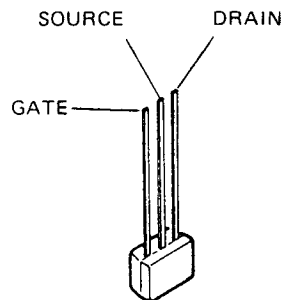

2SK241Y (Q2001,2002)

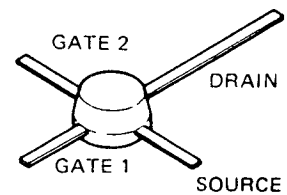

3SK74Y (Q1005)

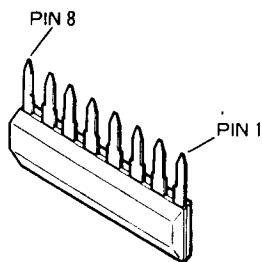

M5218L (Q2006)

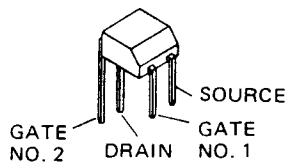

3SK73Y (Q1004)

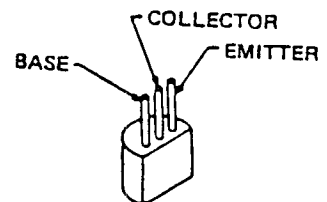

2SA684 (Q1010,Q1011)

6 PARTS LAYOUT

LOCAL UNIT

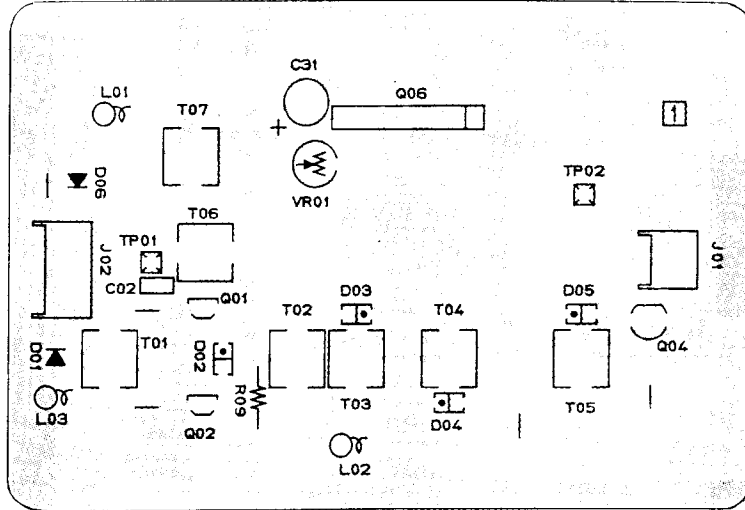

(Obverse view of "component" side)

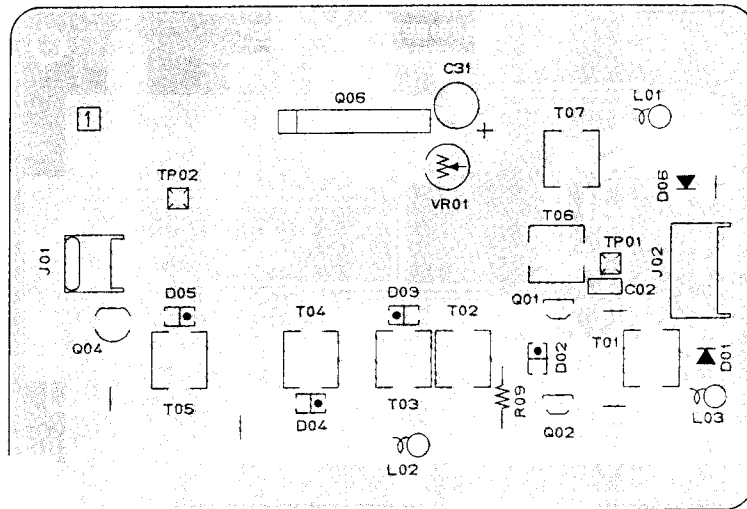

(Reverse view of "component" side)

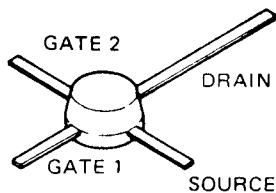

3SK74Y (Q1005)

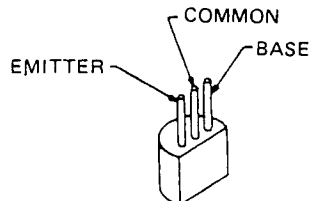

2SC2053 (Q1003)

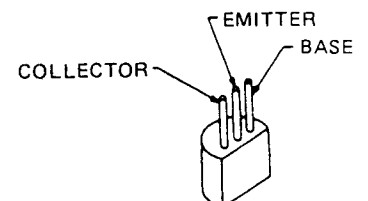

2SC2026 (Q1008)
2SC2407A (Q1009)

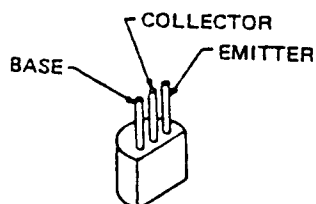

2SA684 (Q1010, Q1011)

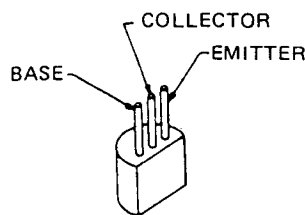

2SC535B (Q1007)
2SC19230 (Q2004)
2SC2001 (Q1012)

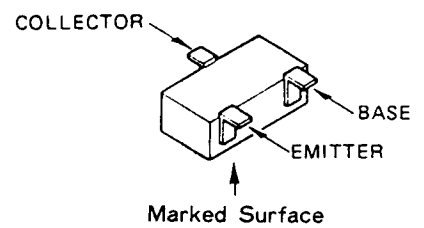

2SC2620QB (Q2003)
2SC1623 (Q2005)

FEX-767-6 PARTS LAYOUT

MAIN UNIT

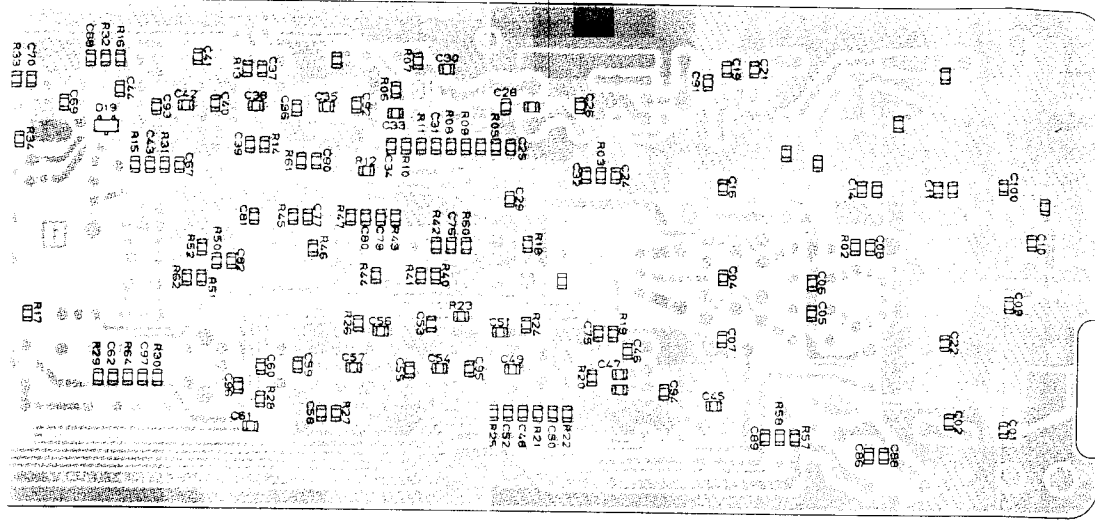

(Obverse view of "chip-only" side)

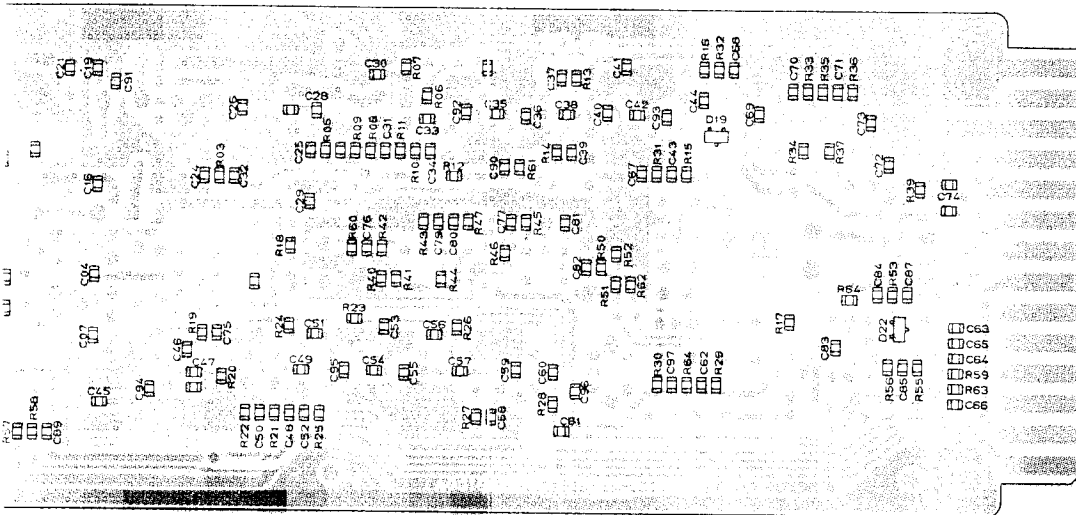

(Reverse view of "chip-only" side)

FEX-767-6 VOLTAGE CHART

(DC VOLTS)

	E		(S)		C		(D)		B		(G ₁)		(G ₂)		REMARKS
	R	T	R	T	R	T	R	T	R	T	R	T	R	T	
02	IN	0.4	11.3	GND	0	0	OUT	0	8.0						MODE USB
03	0	0	13.3	13.3	0.7	0.7									
04	0.4	1.1	0	12.2	1.6	1.6	2.5	2.5							
05	1.3	0	12.4	0	1.4	0	2.5	2.5							
06	1.6	1.6	11.5	11.3	0	0									
07	2.3	0	13.0	0	3.1	0									
08	6.5	6.5	11.6	11.6	7.2	7.2									
09	5.5	5.5	10.5	10.5	6.2	6.2									
10	13.1	13.1	13.0	13.0	12.3	12.3									
11	9.0	9.0	9.0	9.0	8.3	8.3									
12	0	0	13.0	0	0	0.7									
11	0.6		8.9		0										
12	0.6		8.9		0										
13	2.1		8.7		2.8										
14	2.1		6.4		2.8										
15	1.4		8.6		2.1										

PIN No.	
Q1001	RX
	TX
Q2006	

6 PARTS LAYOUT

LOCAL UNIT

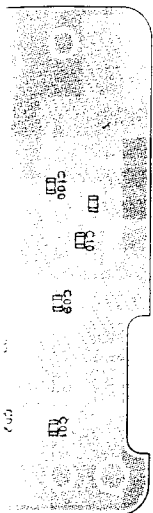

(de)

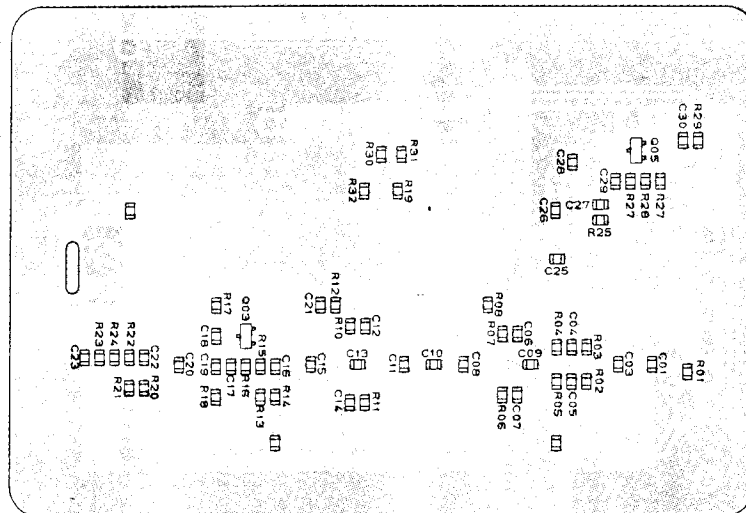

(Obverse view of "chip-only" side)

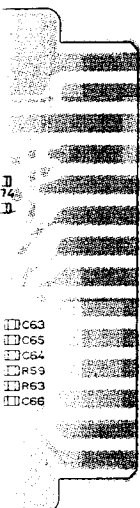

(de)

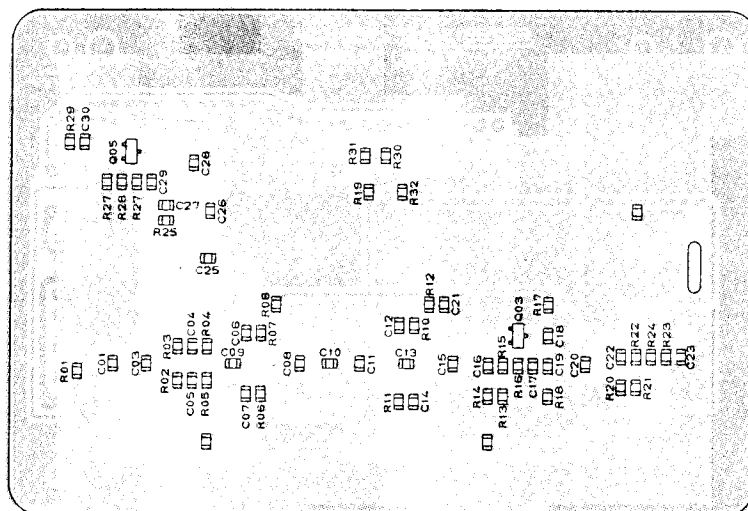

(Reverse view of "chip-only" side)

FEX-767-6 IC VOLTAGE CHART

(DC VOLTS)

PIN No.		1	2	3	4	5	6	7	8	REMARKS
Q1001	RX	—	13.3	0	13.3	—				MODE USB
	TX	—	13.3	8.0	13.3	—				
Q2006		—	—	—	0	—	—	—	9.0	

FEX-767-6 CIRCUIT DIAGRAM

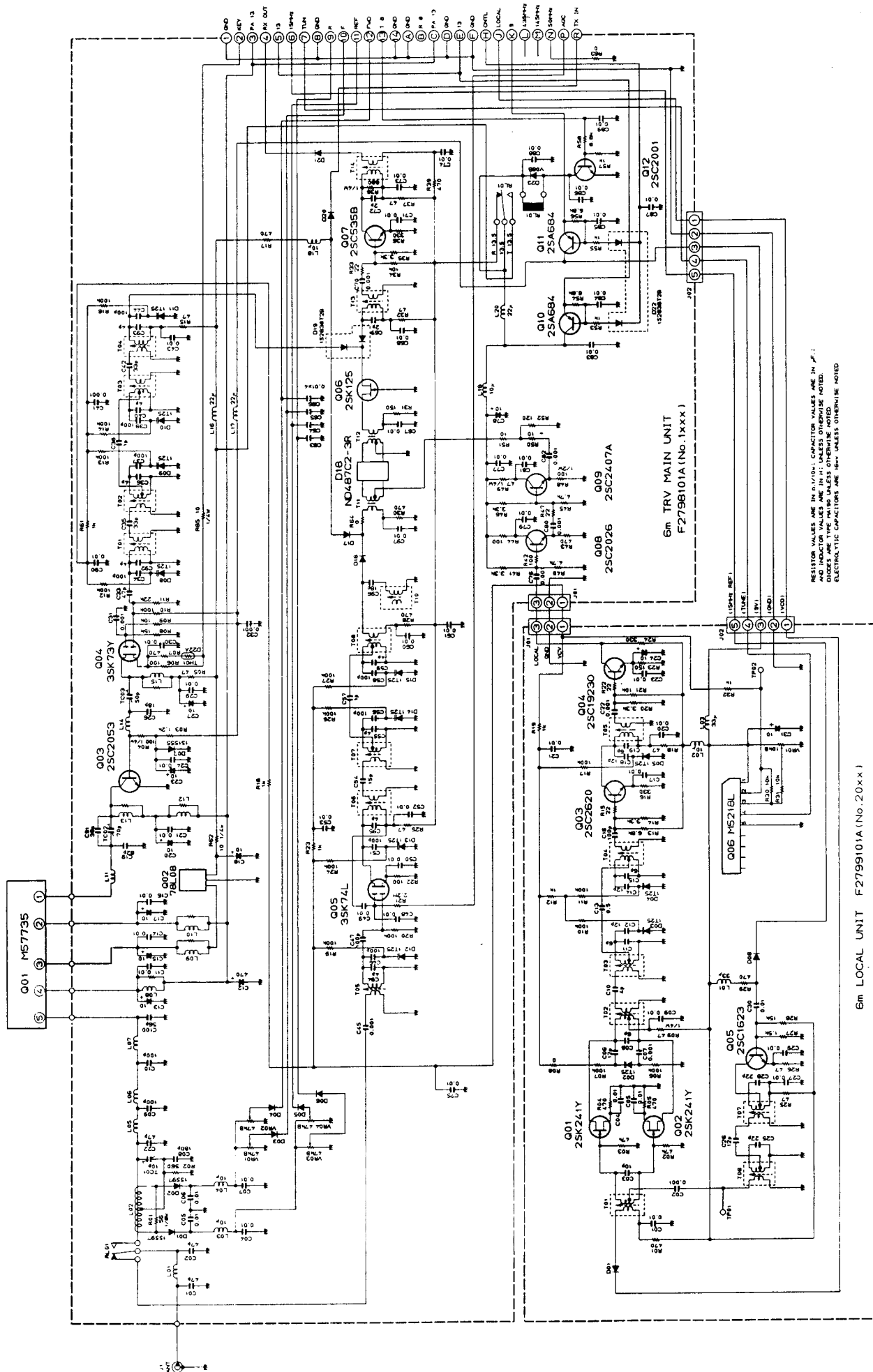

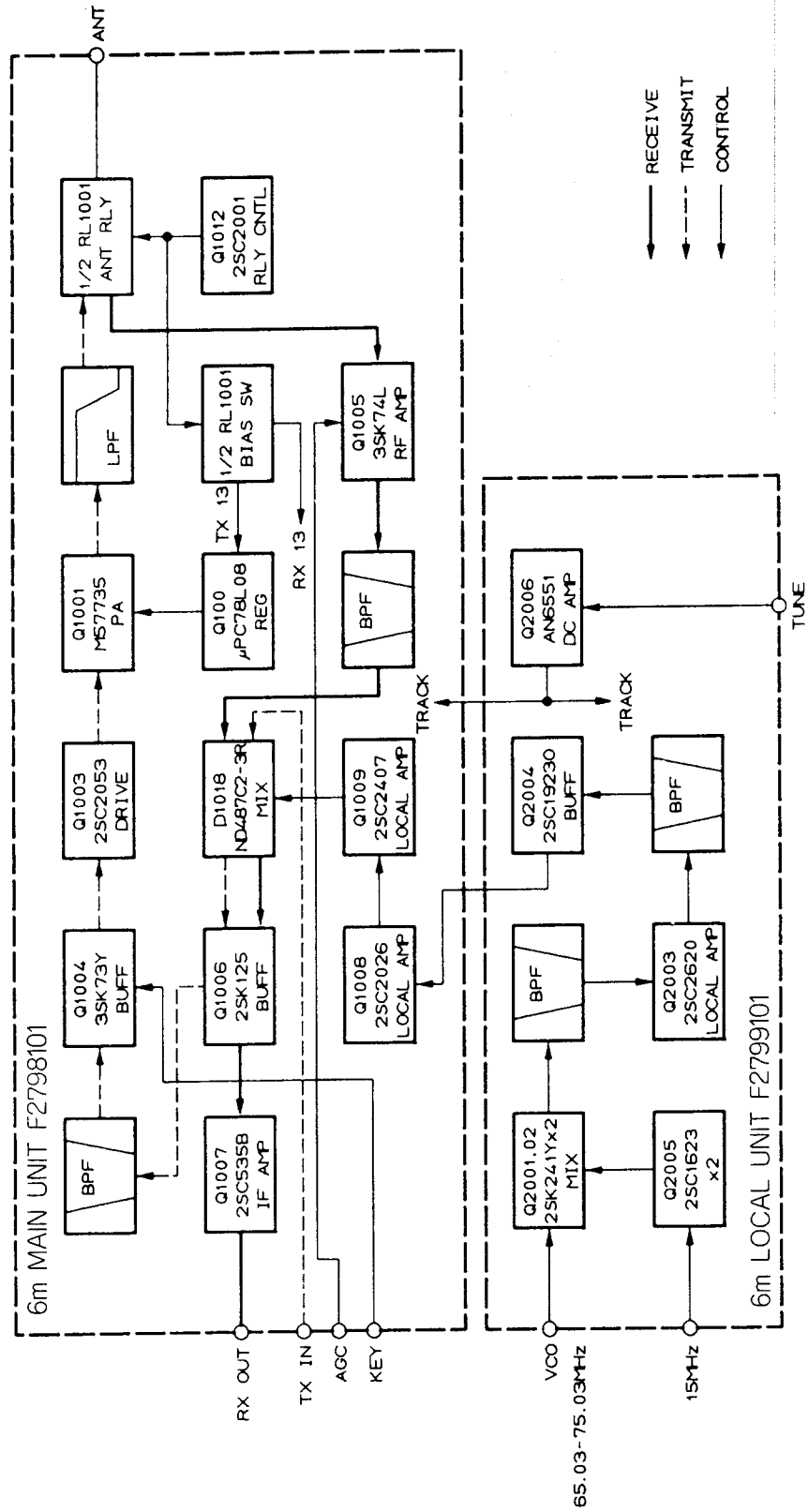

MAIN UNIT

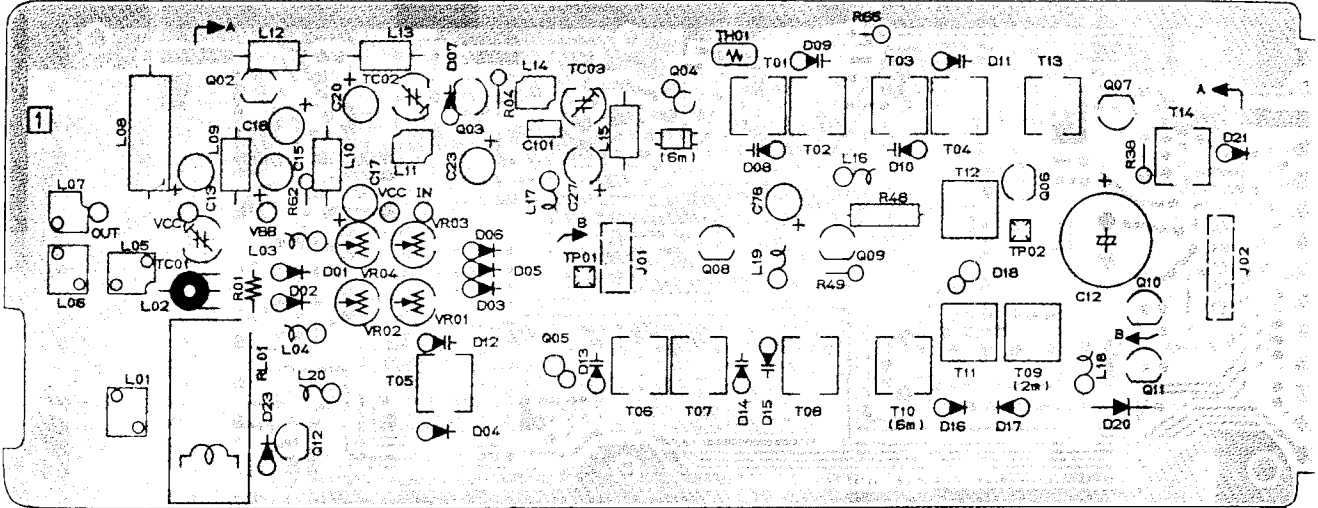

(Obverse view of "component" side)

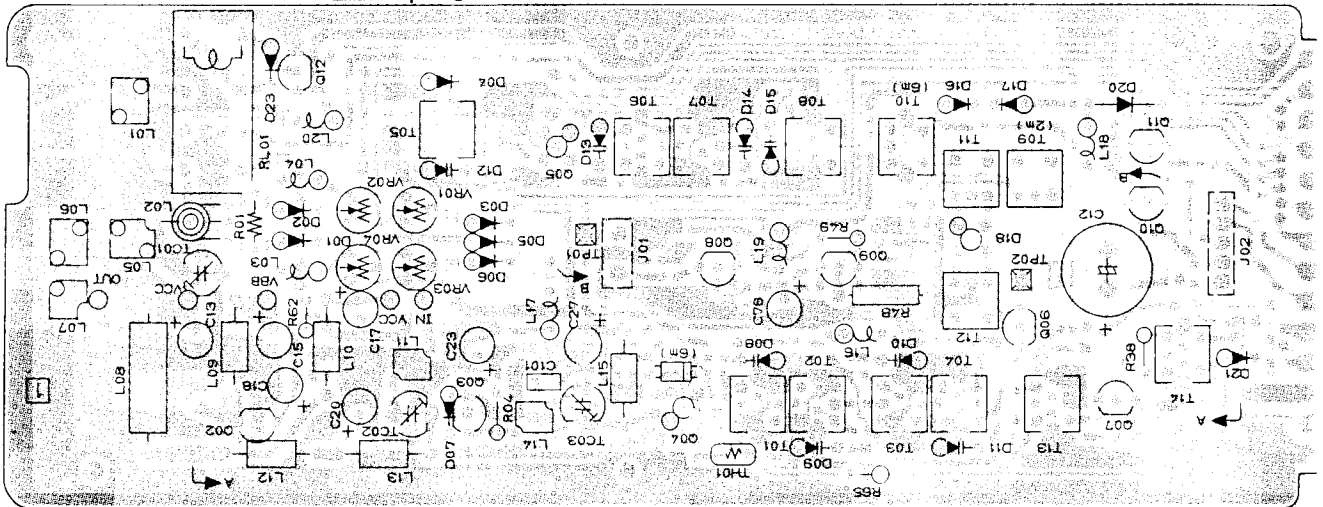

(Reverse view of "component" side)

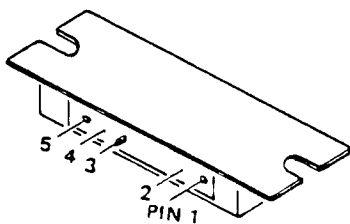

M57713 (Q1001)

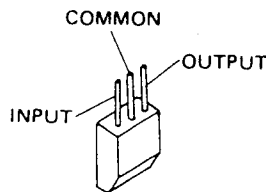

μPC78L05 (Q2005)

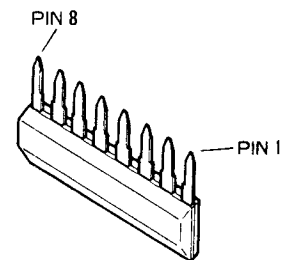

M54455L (Q2007)

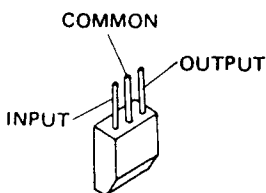

μPC78L08 (Q1002)

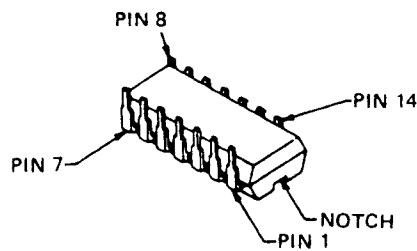

MC4044P (Q2004)
SN74LS73N (Q2006)

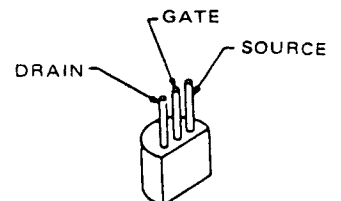

2SK125 (Q1006)

FEX-767-2 PARTS LAYOUT

MAIN UNIT

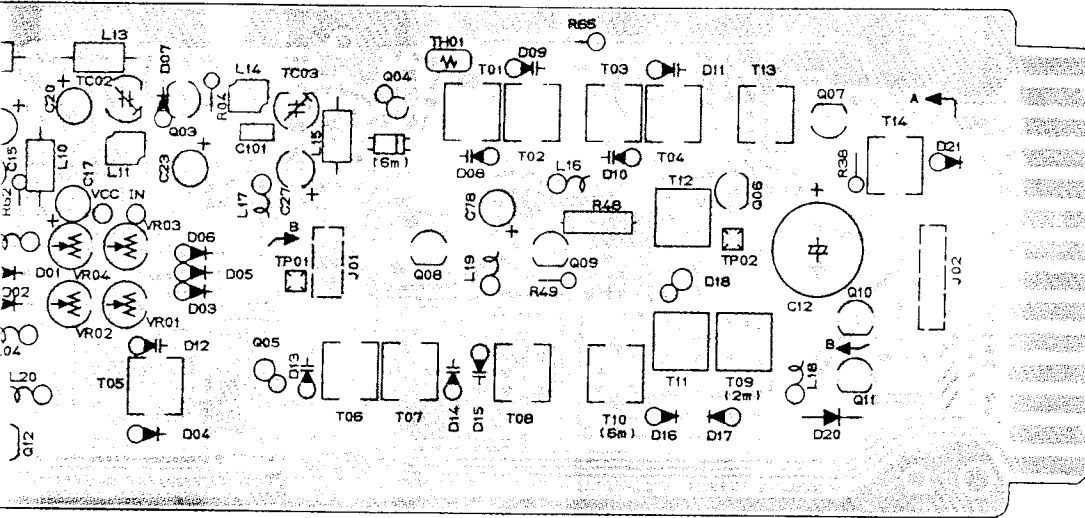

(Obverse view of "component" side)

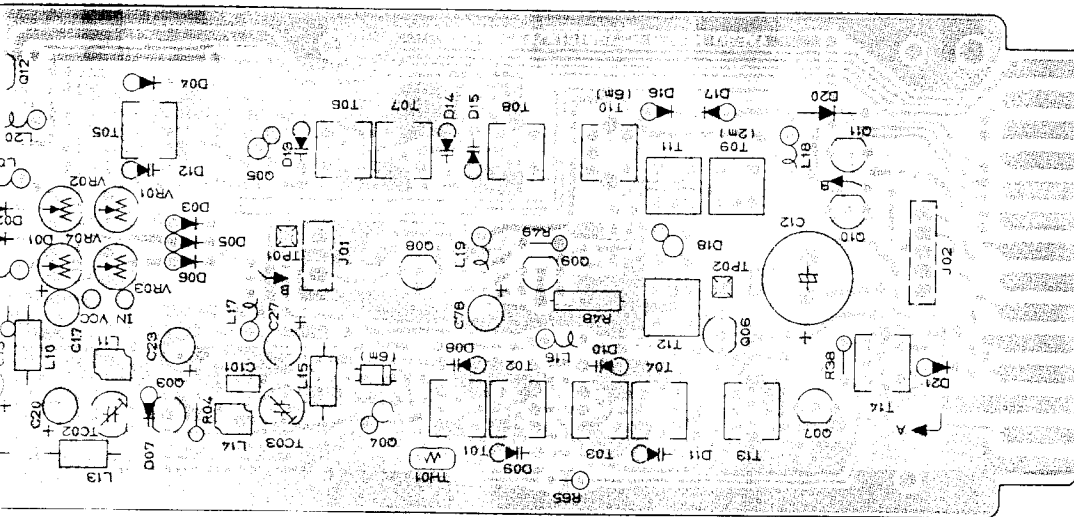

(Reverse view of "component" side)

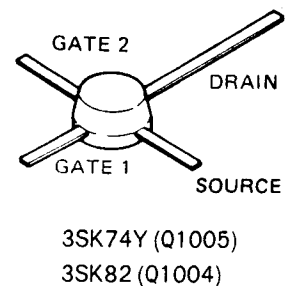
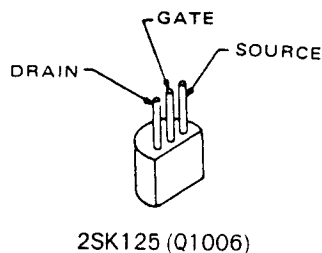
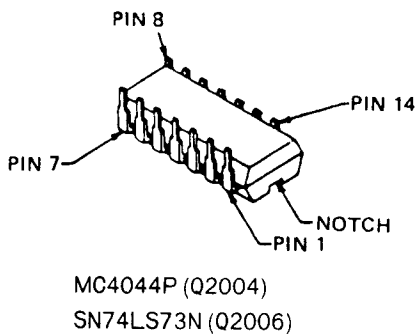
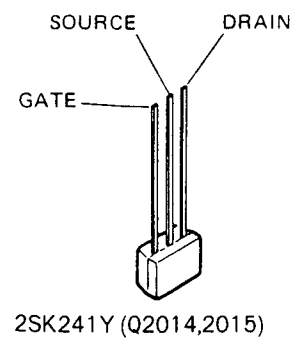
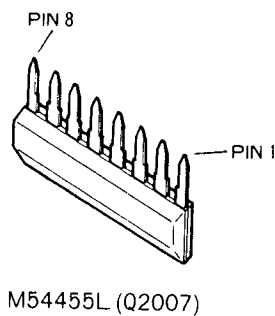
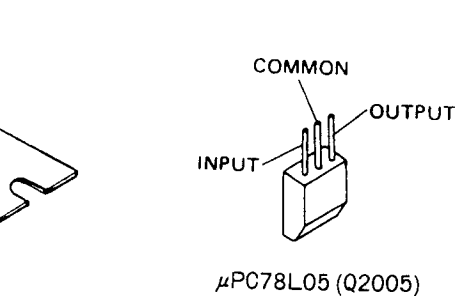

-2 PARTS LAYOUT

PLL LOCAL UNIT

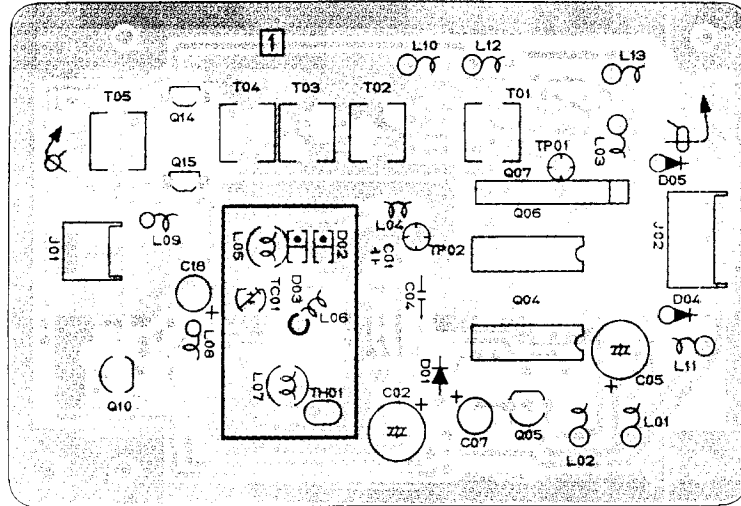

(Obverse view of "component" side)

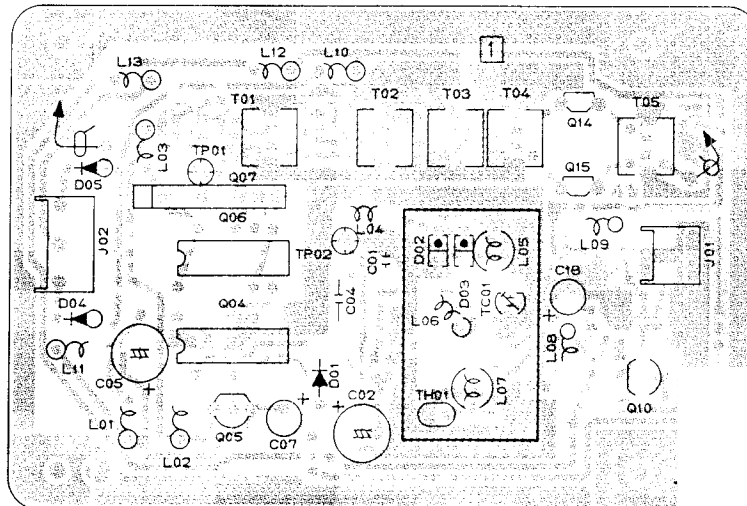

(Reverse view of "component" side)

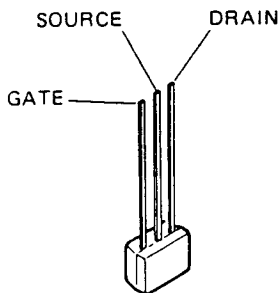

2SK241Y (Q2014,2015)

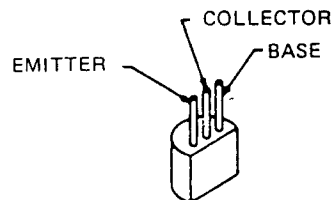

2SA684 (Q1010,1011)
 2SC535B (Q1007)
 2SC2001 (Q1012)
 2SC2407A (Q1009)

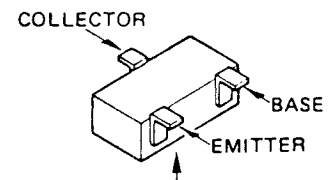

Marked Surface
 2SC2620QB (Q2012,2013,2016)
 2SC2712GR (Q2001-2003)

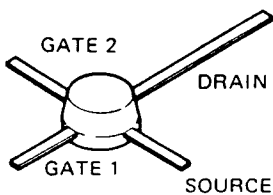

3SK74Y (Q1005)
 3SK82 (Q1004)

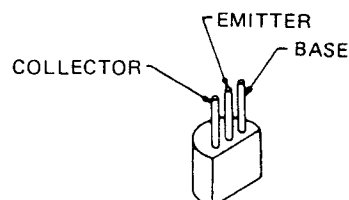

2SC2026 (Q1008)
 2SC2538 (Q1003)

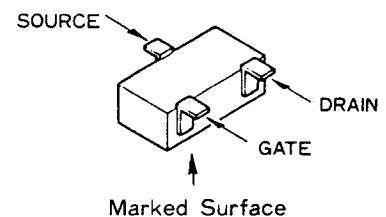

Marked Surface
 2SK302Y (Q2008,2009,2011)

MAIN UNIT

FEX-767-2 PARTS LAYOUT

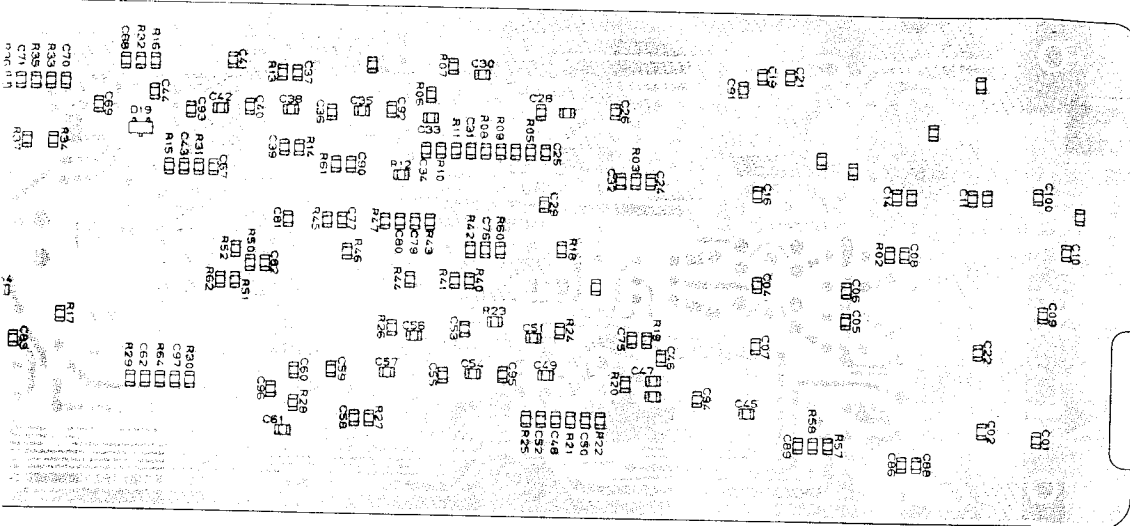

(Obverse view of "chip-only" side)

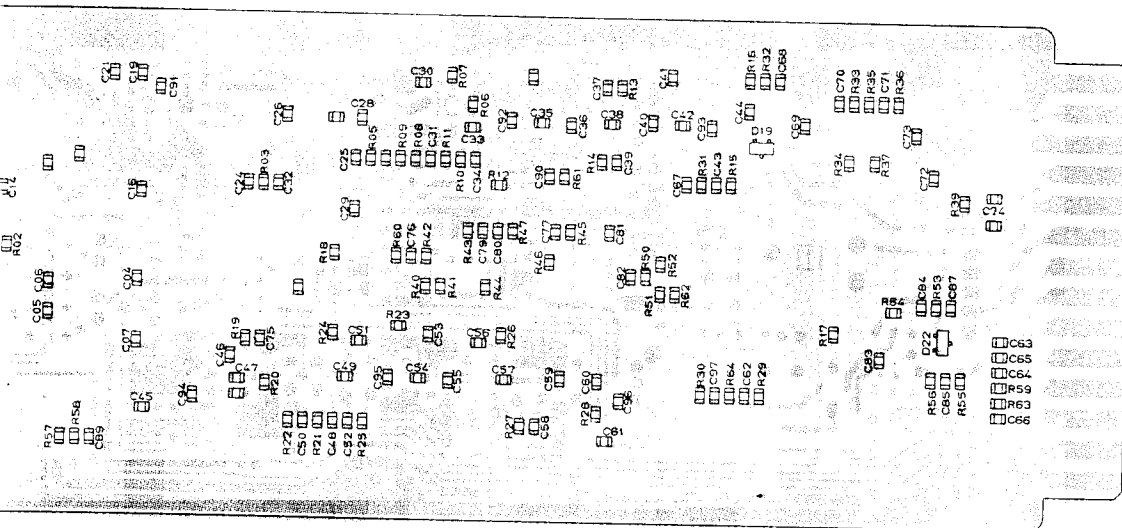

(Reverse view of "chip-only" side)

FEX-767-2 VOLTAGE CHART

(DC VOLTS)

	E		(S)		C		(D)		B		(G ₁)		(G ₂)		REMARKS
	IN	OUT	R	T	R	T	R	T	R	T	R	T	R	T	
002	0.4	11.8	GND	0	0	0	0	0	0	8.0					MODE USB
003	0	0	13.3	13.3	0.7	0.7									
004	0.4	1.2	0	10.0	1.6	1.6	4.5	4.5							
005	1.3	0	12.4	0	1.5	0	2.5	2.5							
006	1.6	1.6	11.5	11.3	0	0									
007	2.3	0	13.0	0	3.1	0									
008	6.5	6.5	11.6	11.6	7.2	7.2									
009	5.5	5.5	10.5	10.5	6.2	6.2									
010	13.1	13.1	13.0	13.0	12.3	12.3									
011	9.0	9.0	9.0	9.0	8.3	8.3									
012	0	0	13.0	0	0	0.7									
013	—	—	8.1	—	—	—									
014	0.3	—	8.4	—	0	—									
015	0.2	—	8.6	—	0	—									
016	1.4	—	5.6	—	1.9	—									
017	0	—	8.6	—	0	—									
018	2.7	—	8.5	—	3.4	—									
019	1.3	—	8.5	—	2.0	—									
020	0.6	—	8.7	—	0	—									
021	0.6	—	8.7	—	0	—									

FE

PIN No.		
Q1001	RX	—
	TX	—
Q2004		—
Q2006		—
Q2007		0

7-2 PARTS LAYOUT

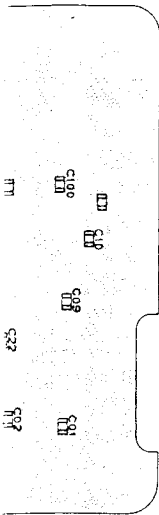

e)

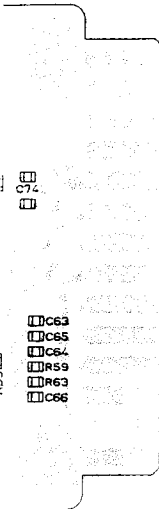

e)

PLL LOCAL UNIT

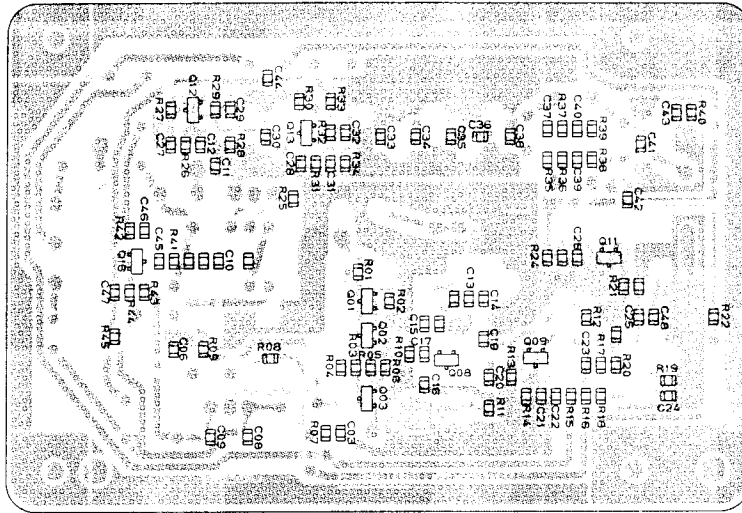

(Obverse view of "chip-only" side)

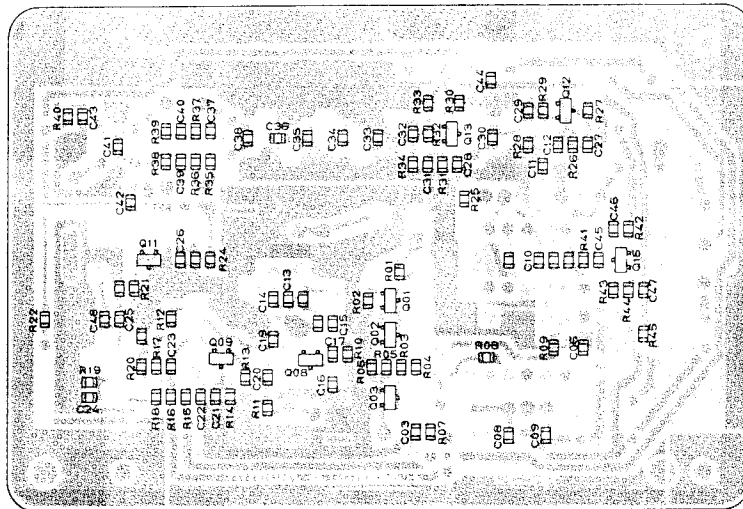

(Reverse view of "chip-only" side)

FEX-767-2 IC VOLTAGE CHART

(DC VOLTS)

PIN No.		1	2	3	4	5	6	7	8	9	10	11	12	13	14	REMARKS
Q1001	RX	—	13.3	0	13.3	—										MODE USB
	TX	—	13.3	8.0	13.3	—										
Q2004		—	—	—	0	0	—	0	—	—	—	—	—	—	5.0	
Q2006		—	—	—	—	—	—	—	—	—	—	0	—	—	5.0	
Q2007		0	—	0	—	0	—	5.0								

FEX-767-2 CIRCUIT DIAGRAM

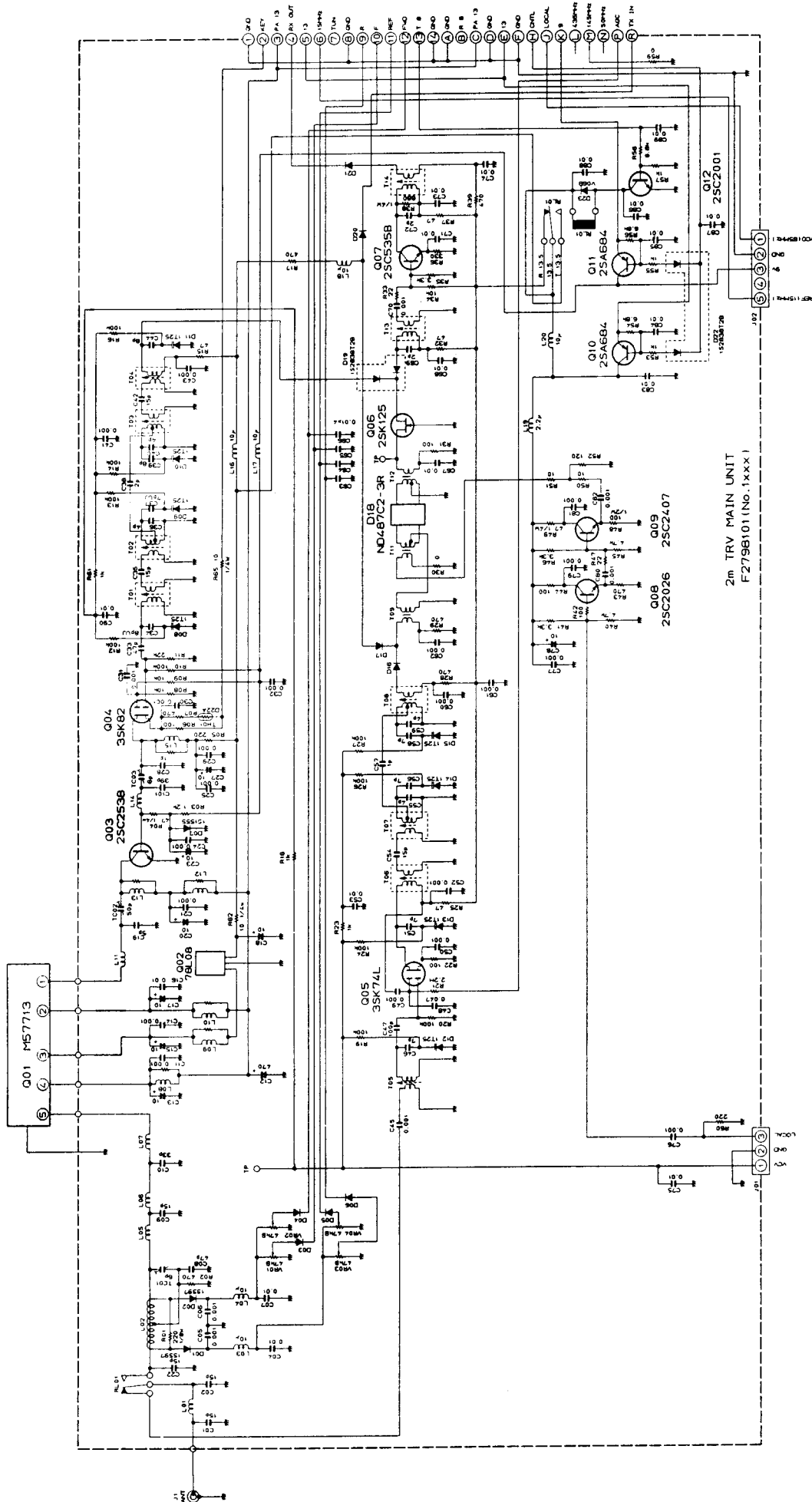

RESISTOR VALUES ARE IN OHMS; CAPACITOR VALUES ARE IN P.F.
 UNLESS OTHERWISE NOTED.
 DIMENSIONS ARE IN INCHES UNLESS OTHERWISE NOTED.
 ELECTROLYTIC CAPACITORS ARE 10% UNLESS OTHERWISE NOTED.

FEX-767-2 CIRCUIT DIAGRAM

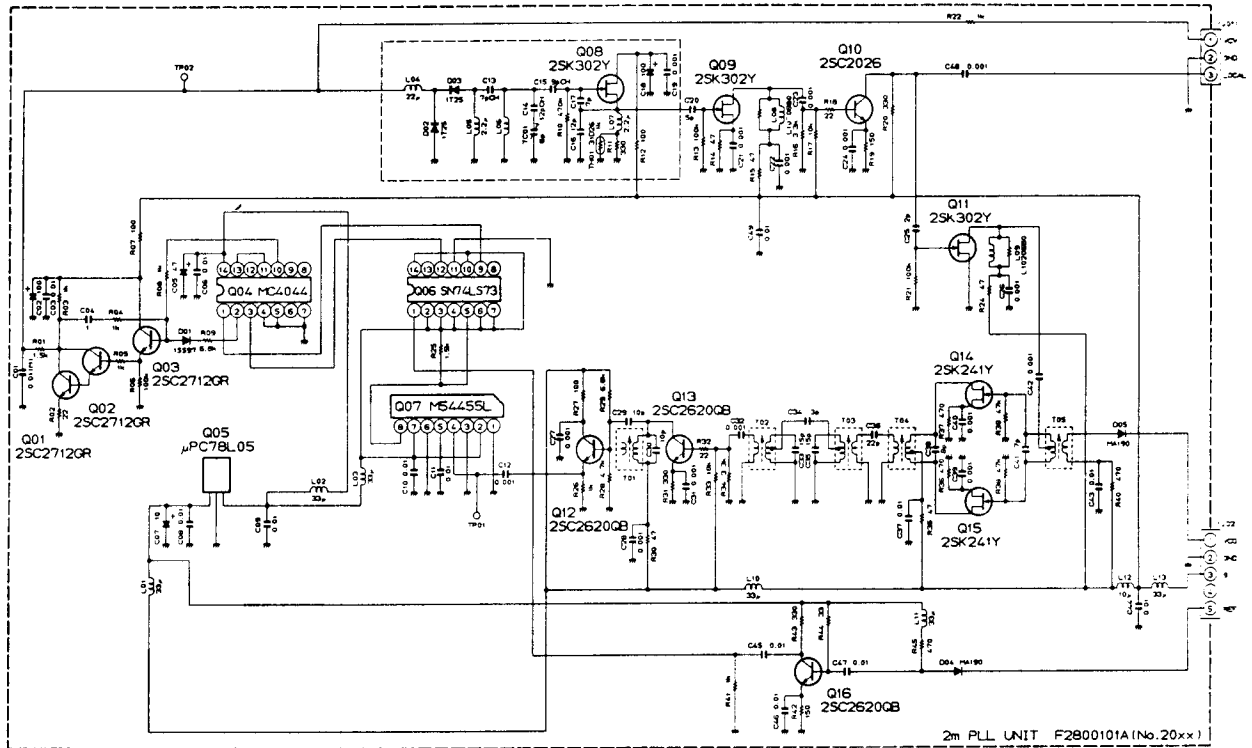

RESISTOR VALUES ARE IN OHMS; CAPACITOR VALUES ARE IN μ F;
AND INDUCTOR VALUES ARE IN H; UNLESS OTHERWISE NOTED.
PMI CAPACITORS ARE POLYESTER FILM 50V.

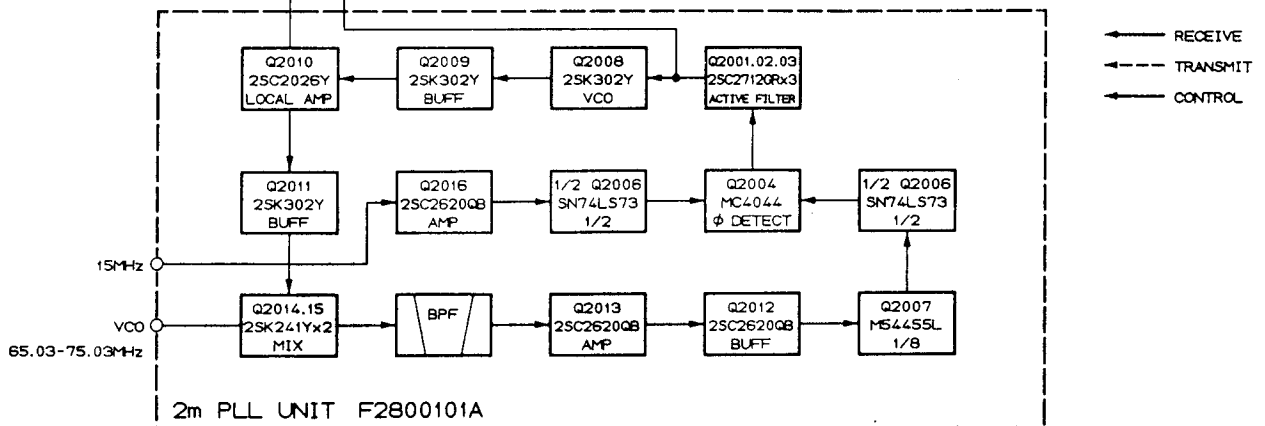
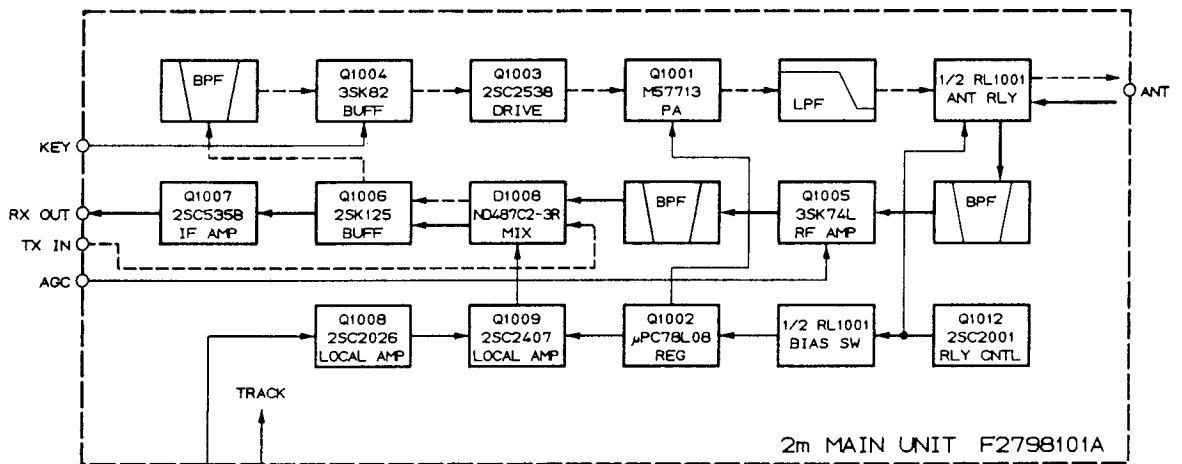

MAIN UNIT

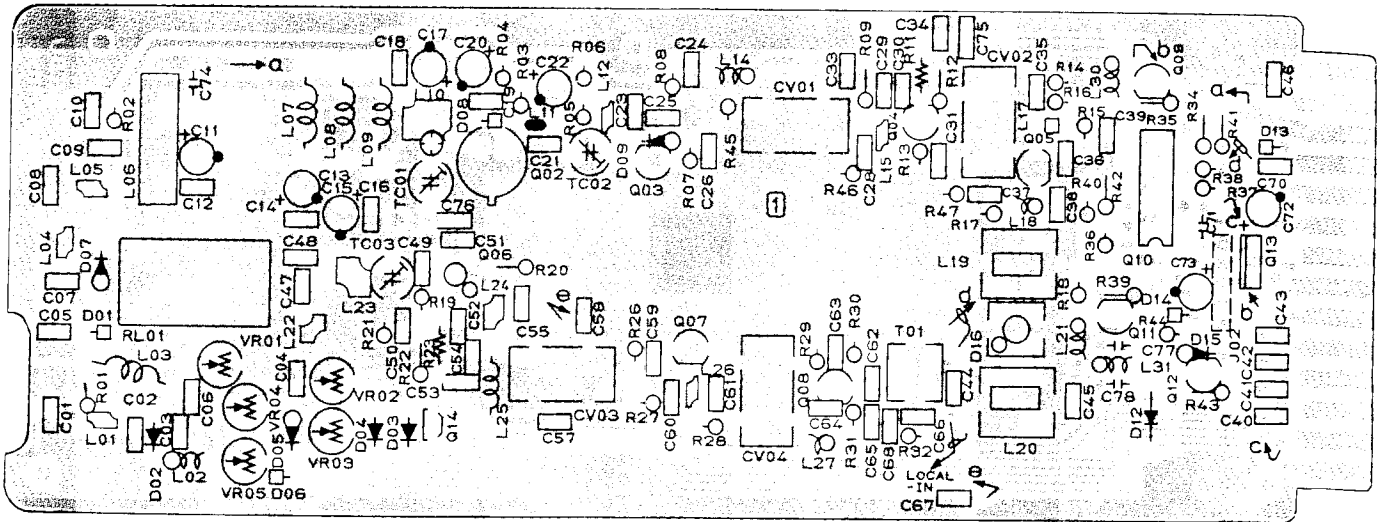

(Viewed from Component side)

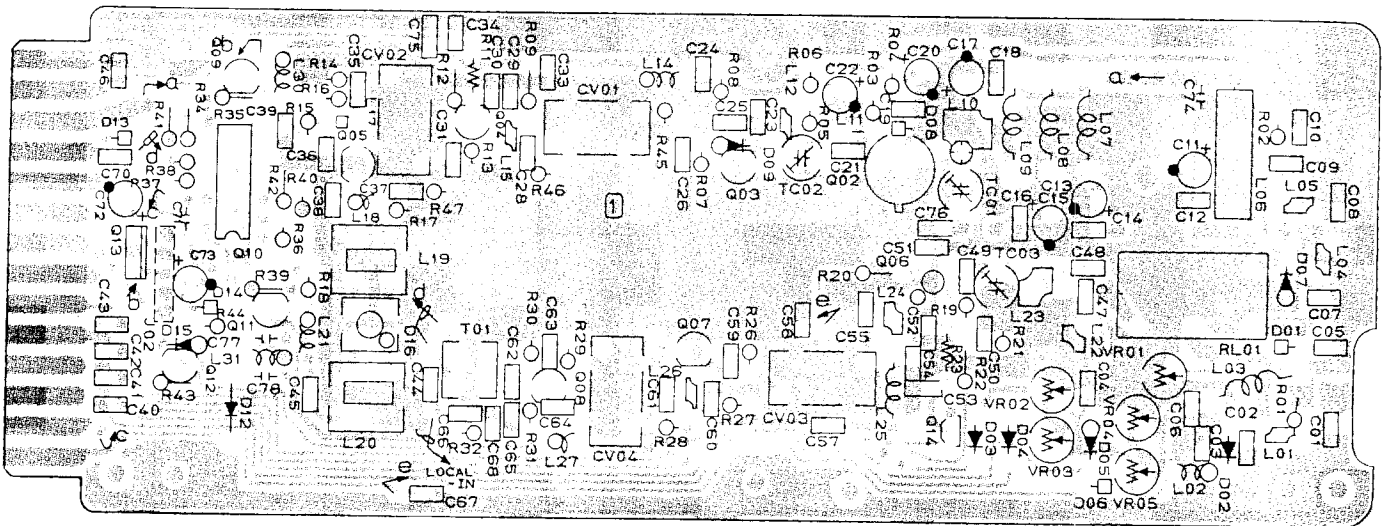

(Viewed from Solder side)

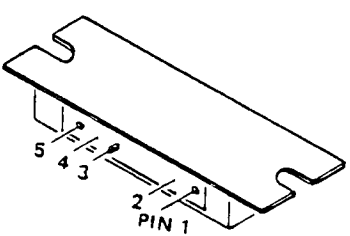

M57716 (Q1001)

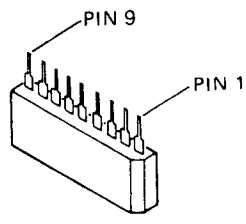

TC5081AP (Q2010)

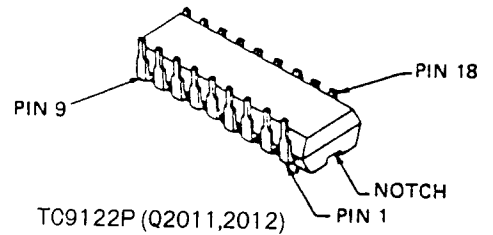

TC9122P (Q2011,2012)

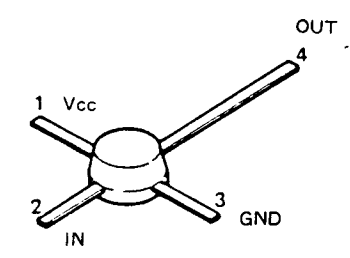

μPC1651G (Q2004-2006)

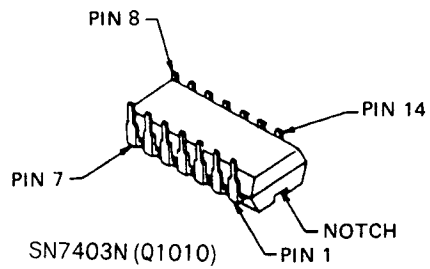

SN7403N (Q1010)

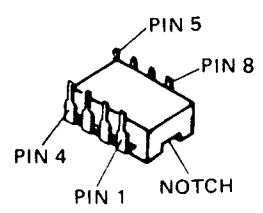

μPB571C (Q2008)

DF

FEX-767-7 PARTS LAYOUT

MAIN UNIT

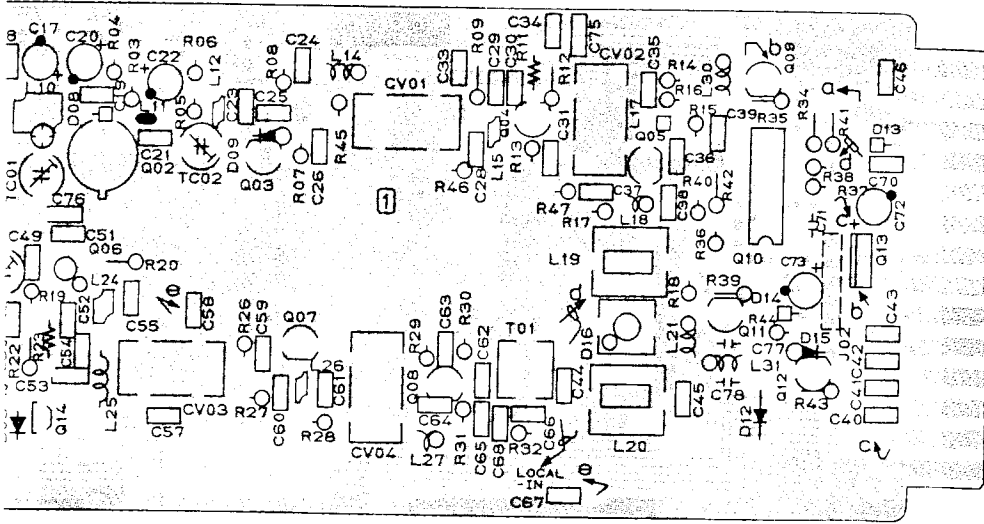

(Viewed from Component side)

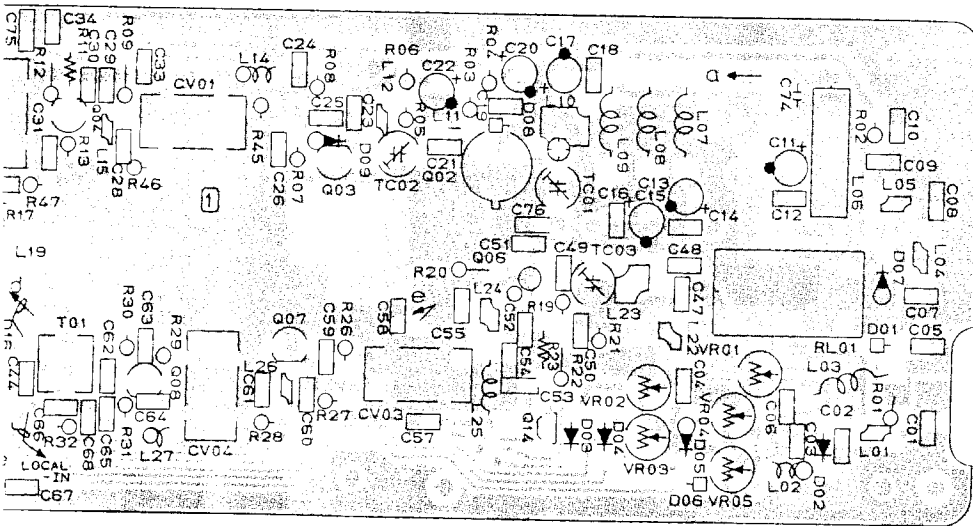
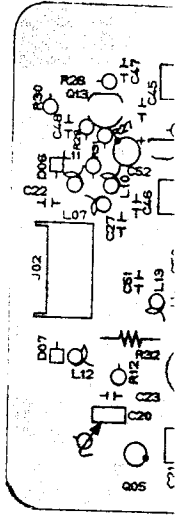

(Viewed from Solder side)

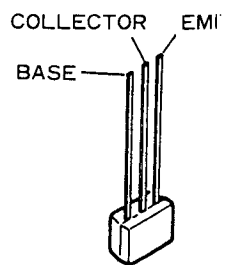
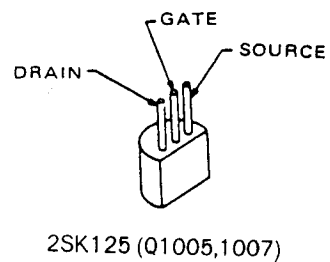
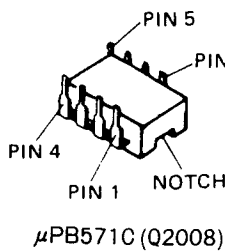
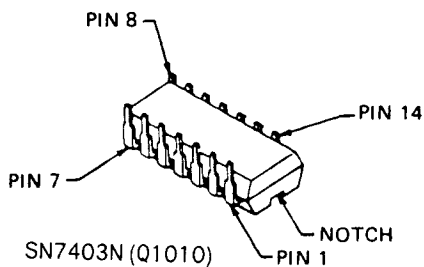
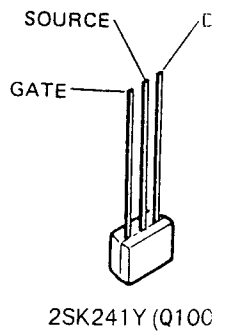
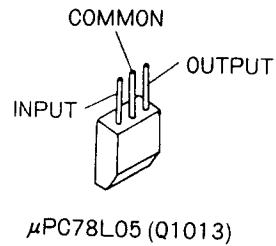
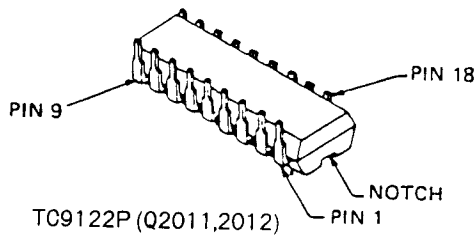
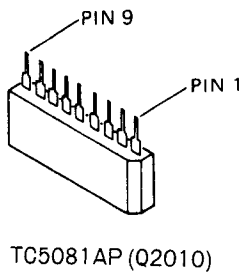
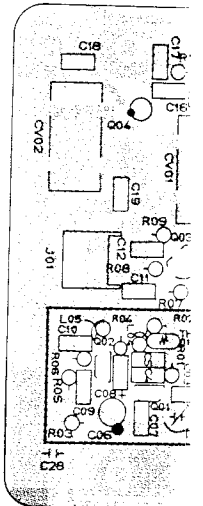

PLL LOCAL UNIT

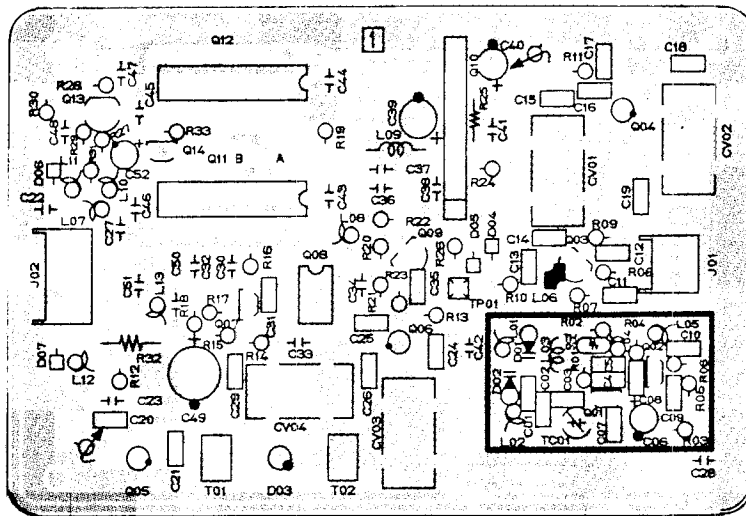
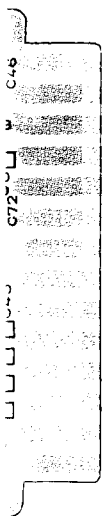

(Viewed from Component side)

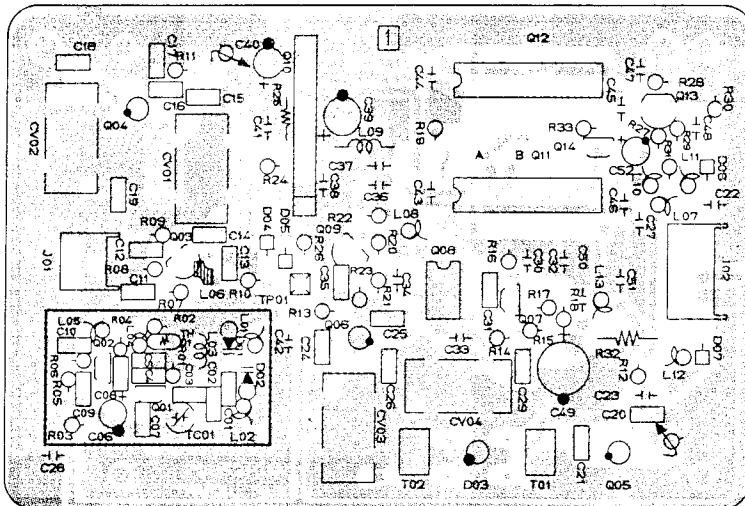
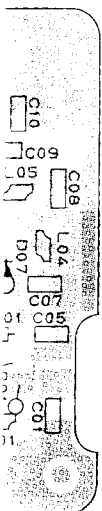

(Viewed from Solder side)

-PIN 18

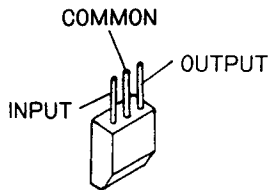

μPC78L05 (Q1013)

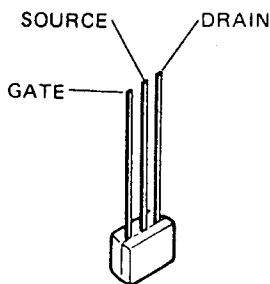

2SK241Y (Q1008)

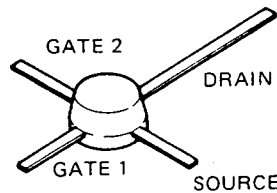

3SK121GR (Q1006)

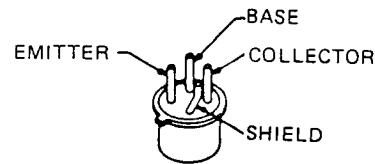

2SC1426 (Q1002)

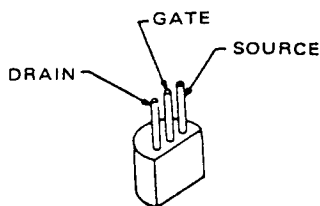

2SK125 (Q1005,1007)

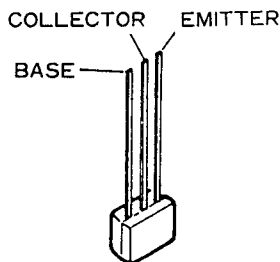

BA1L4L (Q1014)

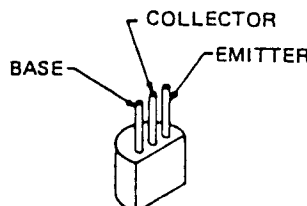

2SA684 (Q1009,1011,1012)
2SC945P (Q2009,2013)
2SC3354T (Q2007)

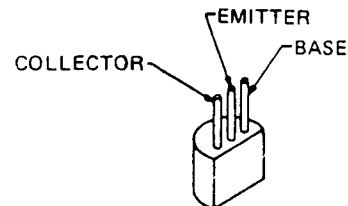

2SC2026 (Q2003)
2SC2407A (Q1003)
2SC3355 (Q1004)

FEX-767-7 VOLTAGE CHART

(DC VOLTS)

	E		(S)		C		(D)		B		(G ₁)		(G ₂)		REMARKS
	R	T	R	T	R	T	R	T	R	T	R	T	R	T	
Q1002	0	0	13.3	13.3	0	0.7									MODE USB
Q1003	0	0	0	8.3	0	0.8									
Q1004	0	1.9	0	7.9	0	2.6									
Q1005	0	1.6	0	8.1	0	0									
Q1006	2.9	4.7	9.0	9.0	1.6	1.6	3.0	3.0							
Q1007	1.5	0	11.5	0	0	0									
Q1008	0.9	0	13.0	0	0	0									
Q1009	9.0	9.0	0	8.8	9.0	8.2									
Q1011	13.1	13.1	13.0	0	12.3	13.1									
Q1012	9.1	9.1	9.0	9.0	8.3	8.3									
Q1013	IN 9.0	9.0	GND 0	0	OUT 5.0	5.0									
Q2001	1.0		8.4		0										
Q2002	0.1		8.8		0										
Q2003	0.9		8.8		1.5										
Q2007	0.8		7.7		1.3										
Q2009	0.9		3.0		1.5										
Q2013	0.9		3.1		1.5										
Q2014	8.0		0		8.0										

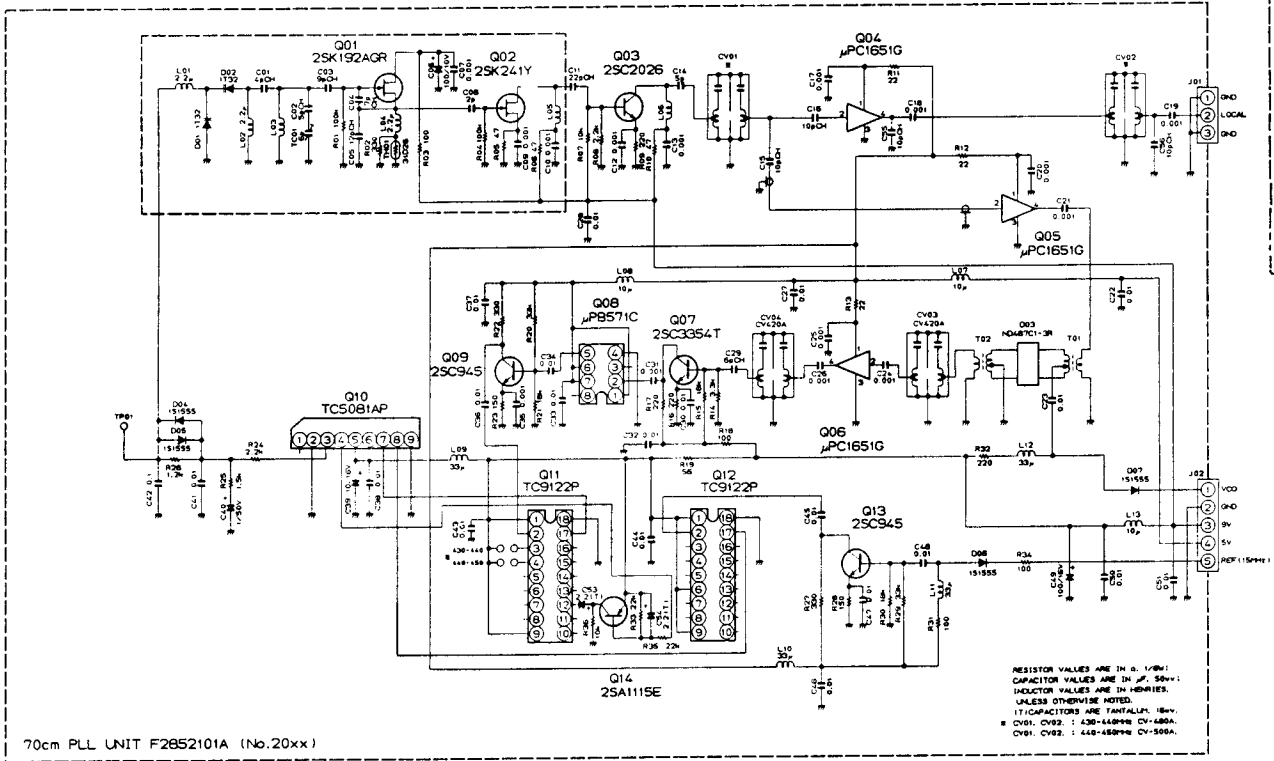
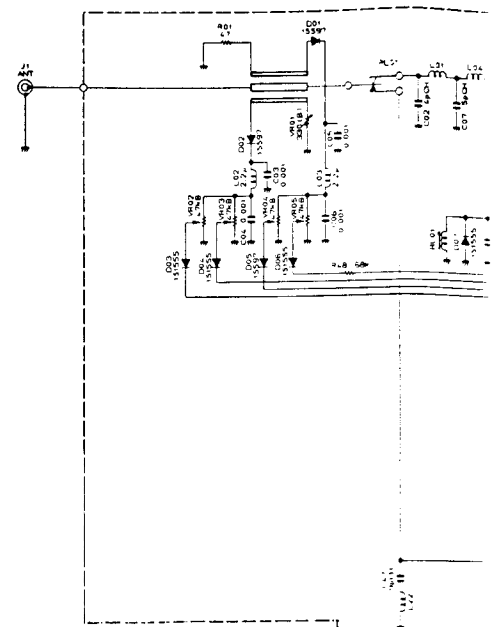

FEX-767-7 IC VOLTAGE CHART

(DC VOLTS)

PIN No.	1	2	3	4	5	6	7	8	9	10	11	12	13	14	15	16	17	18	REMARKS
Q1001	RX	-	0	0	0	-													MODE USB
	TX	-	8.6	13.3	13.3	-													
Q1010	-	-	-	-	-	-	0	-	-	-	-	-	-	5.0					
Q2004	4.6	0.9	0	3.1															
Q2005	4.6	0.9	0	3.4															
Q2006	4.6	0.9	0	3.0															
Q2008	5.0	-	-	0	-	5.0	5.0	-											
Q2010	-	0	-	-	8.0	-	-	-	0										
Q2011	8.0	-	-	-	-	-	-	-	-	-	-	-	-	-	-	-	-	0	
Q2012	8.0	-	-	-	-	-	-	-	-	-	-	-	-	-	-	-	-	0	

FEX-767-7 CIRCUIT

VOLTAGE CHART

(DC VOLTS)

P)	B		(G ₁)		(G ₂)		REMARKS
	R	T	R	T	R	T	
3.3	0	0.7					MODE USB
8.3	0	0.8					
7.9	0	2.6					
8.1	0	0					
9.0	1.6	1.6	3.0	3.0			
0	0	0					
0	0	0					
8.8	9.0	8.2					
0	12.3	13.1					
9.0	8.3	8.3					
0	OUT 5.0	5.0					
0							
0							
	1.5						
	1.3						
	1.5						
	1.5						
	8.0						

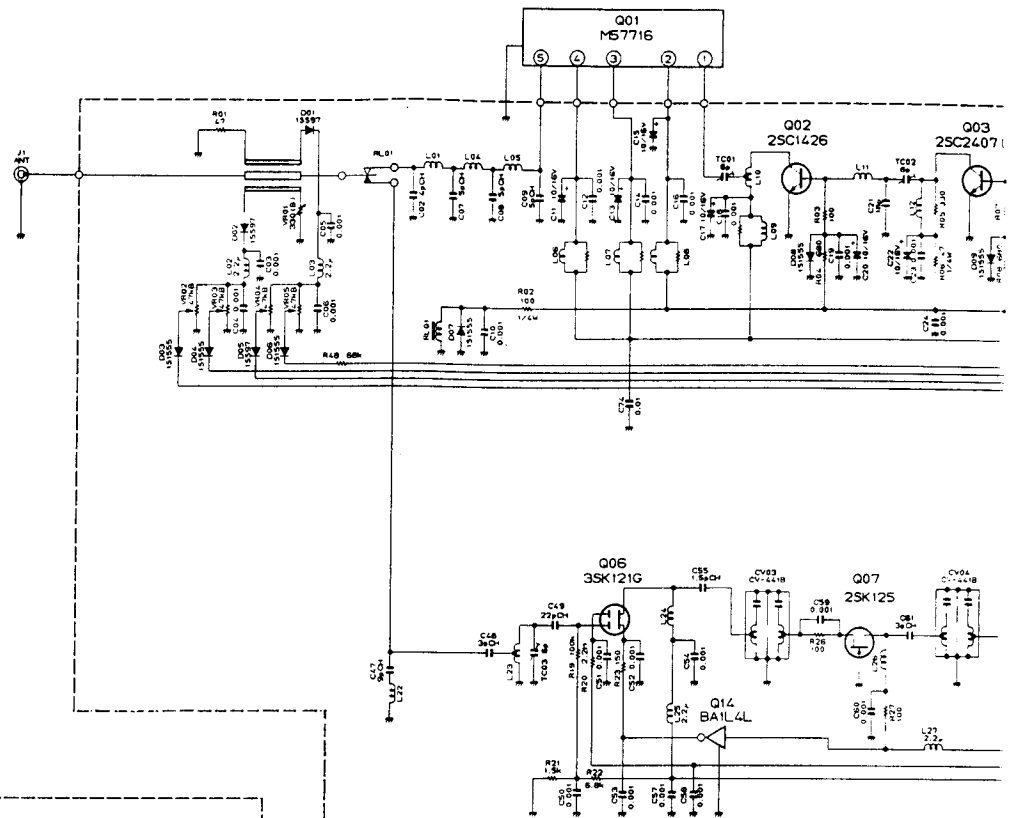

RESISTOR VALUES ARE IN Ω, 1/10Ω;
CAPACITOR VALUES ARE IN μF, 50nV;
INDUCTOR VALUES ARE IN HENRIES, UNLESS OTHERWISE NOTED.

70cm TRV MAIN UNIT F2851101 (No. 10x)

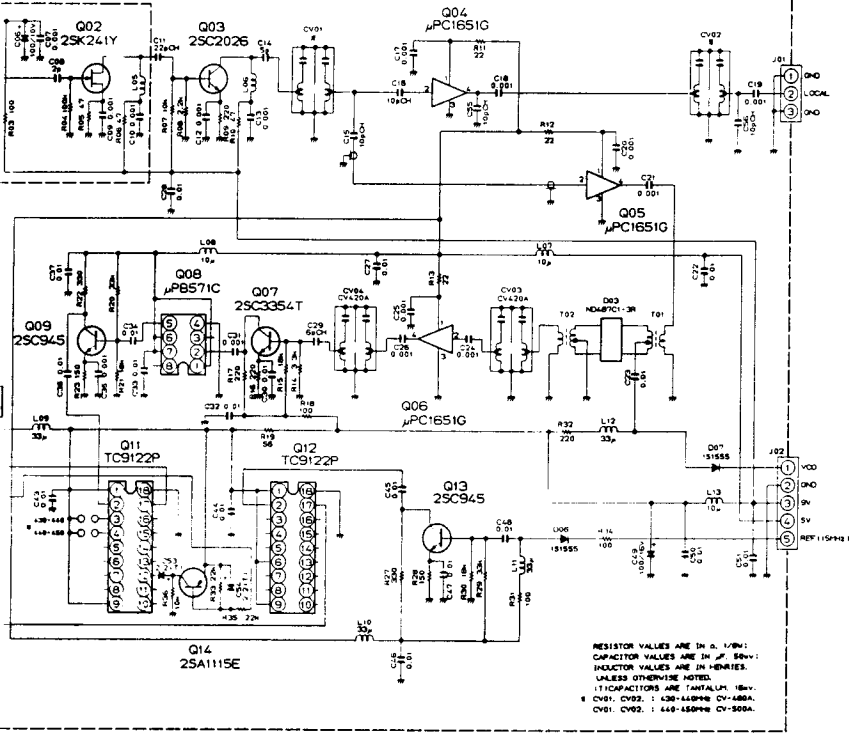

RESISTOR VALUES ARE IN Ω, 1/10Ω;
CAPACITOR VALUES ARE IN μF, 50nV;
INDUCTOR VALUES ARE IN HENRIES, UNLESS OTHERWISE NOTED.
† INDICATORS ARE TYPICALLY 15nV.
C1, C2, C3 : 100-150pF CV-480A.
C4, C5, C6 : 100-150pF CV-500A.

Q14
25A1115E

FEX-767-7 IC VOLTAGE CHART

(DC VOLTS)

6	7	8	9	10	11	12	13	14	15	16	17	18	REMARKS
0	0	0	0	0	0	0	0	5.0	0	0	0	0	MODE USB
0	5.0	0	0	0	0	0	0	0	0	0	0	0	
0	0	0	0	0	0	0	0	0	0	0	0	0	
0	0	0	0	0	0	0	0	0	0	0	0	0	

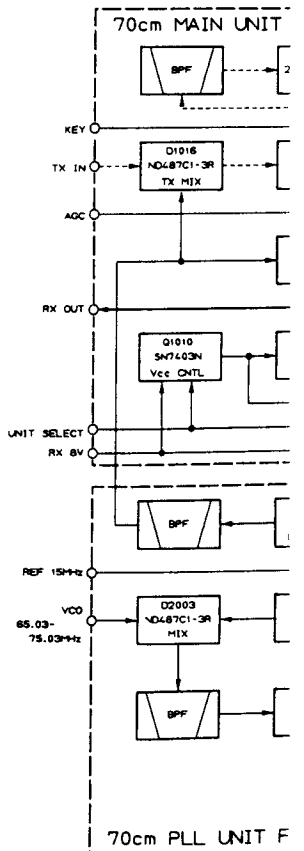

70cm PLL UNIT F

FEX-767-7 CIRCUIT DIAGRAM

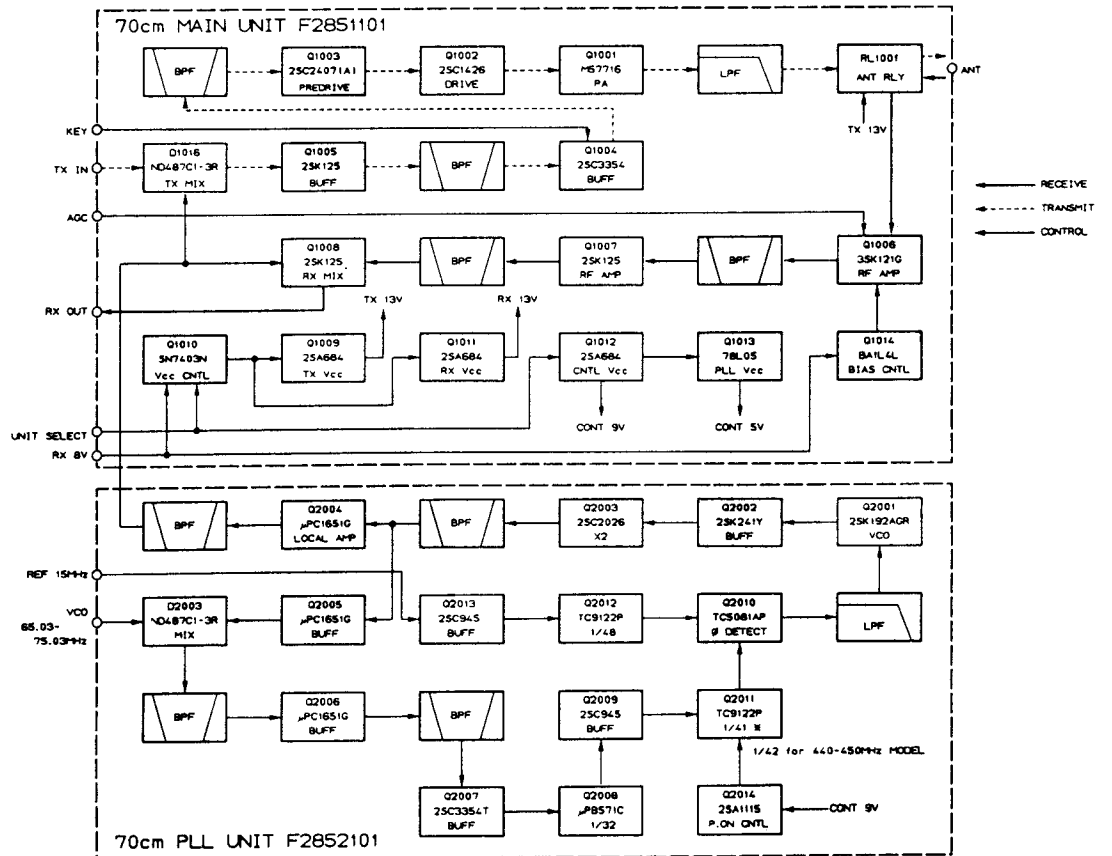
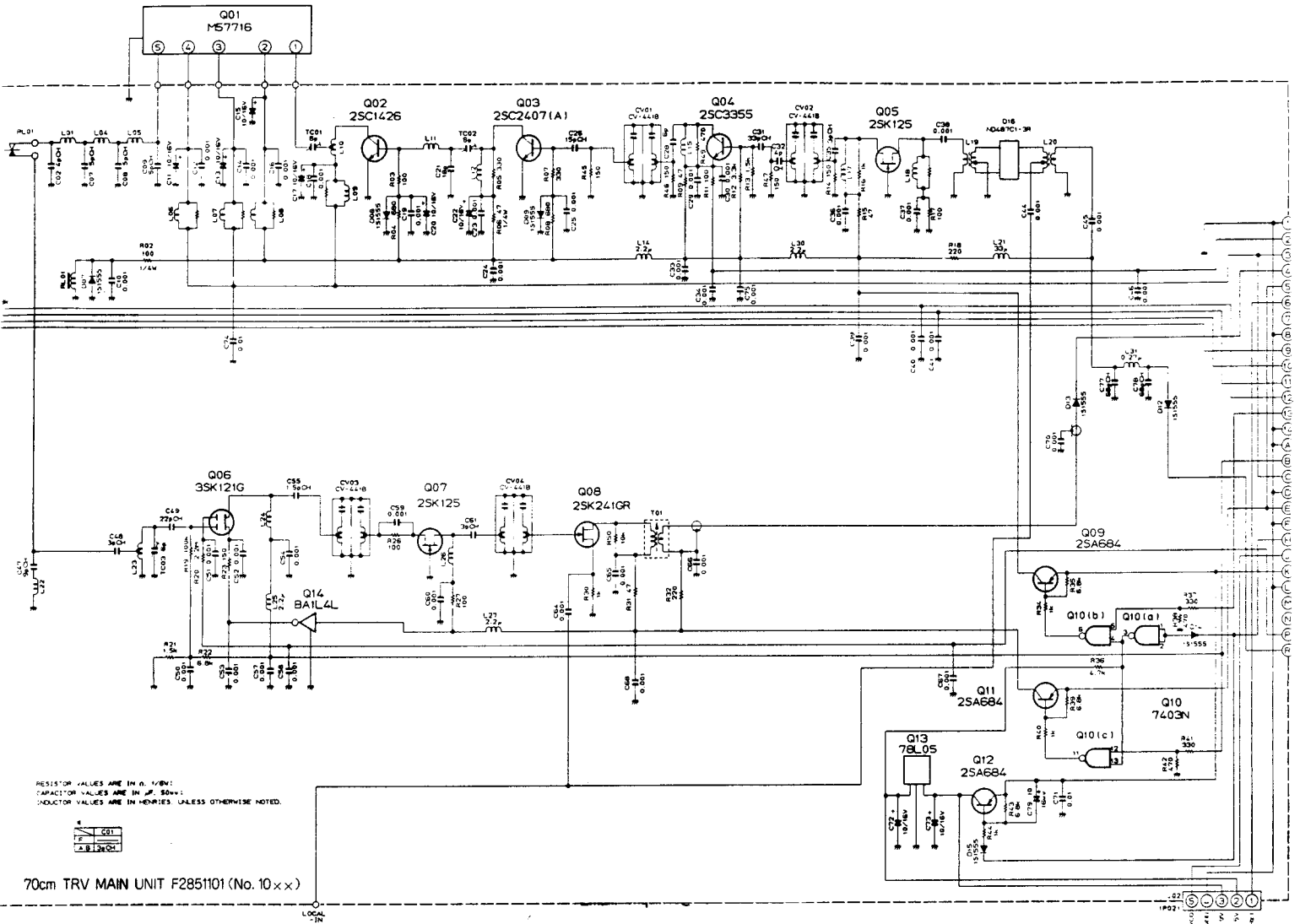

FT-767GX PARTS LIST

MAIN CHASSIS				R3100830C	Push knob E D LOCK
Symbol No.	Part No.	Name & Description		R3115320	Knob UP
		DIODES		R3115330	" DOWN
D1	G2090121	S25VB10		R3115340	" BAND UP
D2	G2090356	S10VB10		R3115350	" BAND DOWN
				R3116820	" LSB,USB,CW,AM,FSK, FM,SWR,RF,PWR
		CAPACITORS			
C1, 2	K12329001	Ceramic 1.4kV 0.01µF (ECK-DAL103PE)		R3115310	" POWER
C3	K13179008	" 50WV 0.01µF F (DD106F103Z50)		R3115390	" MOX
C4*	K13179009	" " 0.047µF " (DD110F473Z50)		R3115400B	" DISC,VOX,FULL BK-IN, PROC,MONI,TX SHIFT, T ENC,NOR,RF AMP, ATT,FAST,MIC U/D, KEYER
C5	K12171102	" " 0.001µF E (DD104E102P50)		R3115450	" AC 0
				R3115451	" CLAR 1
		POWER TRANSFORMER		R3115452	" MCK 2
PT1	L3030121			R3115453	" OFFSET 3
				R3115454	" MR 4
		METER		R3115455	" SPLIT 5
M1	M0290053			R3115456	" VFO M 6
				R3115457	" SCAN 7
		COOLING FAN & MOTOR		R3115458	" M VFO 8
MO1*	M2190004	MDN-7R1		R3115459	" VFO M 9
	R0115060A	Motor Holder		R3115460	" TRACK
	R3500250	Radial Fan		R3115461	" VFO A B CE
P66	T9205210	Wire Assy		R3115462	" H/G ENT
		ROTARY ENCODER		R3115463	" PMS V/U
	Q9000358A	REL-250		R3115464	" FUNC TSET
		SPEAKER		R3104081	Push knob RX ANT (NOR/SEP), BACKUP,MARK, LINEAR AMP
SP1	M4090061	SS-70T			
		SWITCHES			
S1	N4090107	SDL B			
S2	N7090042	HXW0113			
S3	N6090059	SDKGA4			
S4	N7090041	OHD2-60M			
			RF UNIT		
			Symbol No.	Part No.	Name & Description
				F2781000B	Printed Circuit Board
		CONNECTORS		C027810AA	PCB with Components
J1	T9205216				
J2					ICs
J3	P0090094	AP-300-3A1	Q2002	G1090108	MC14518BCP
J4	P1090352	FM-MDR-M1	Q2016	G1090686	LA6458S
J5	P0090158	FM-214-8SSA	Q2017	G1090649	M5218
			Q2026	G1090257	MC14066BCP
		FUSE			FETs
F1	Q0000007	10A 100-117V AC			
F1	Q0000005	5A 220-234V AC	Q2004-2008, 2011	G3801250	2SK125
			Q2009	G4800740L	3SK74L
		FUSE HOLDER	Q2019	G3801921G	2SK192A-GR
FH1	P2000012	S-N2059	Q2020, 2025	G3801040J	2SK104J
		LAMPS			TRANSISTORS
PL1, 2	Q1000047	BQ044-32514M 14V	Q2001, 2003, 2018, 2030, 2040	G3309451Q	2SC945AQ
		FERRITE BEADS	Q2010, 2012	G3090010	2N4427
FB1	L9190010	3A RI9.3x4.8-5	Q2013, 2028, 2029	G3090075	BN1A4P
			Q2031-2039	G3090078	DTA143ES
		KNOB	Q2014, 2015	G3090074	BA1A4M
	R3116100A	FT-50U Main Knob Assy	Q2021, 2024, 2027	G3107331P	2SA733AP
	R3108960A	Knob VOX GAIN PROC MONI			
	R6108980B	Cap TX SHIFT,AGC,DIM			DIODES
	R3101020B	FT-14VK METER	D2001, 2002, 2029- 2033, 2035-2039, 2042-2045, 2049- 2057, 2059-2067, 2069, 2070	G2090027	1SS53 Si
	R3100770B	FT-13WK MIC,SQL,AF,SHIFT NOTCH,KEYER			
	R6100760A	FT-18D DRIVE, NB, RF, TONE, APE, PITCH			

* 100W Type

D2003-2028, 2034, 2047	G2090340	1SS83 Si	R2108, 2111, 2150	J02245473	" " " 47kΩ "
			R2135	J02245683	" " " 68kΩ "
D2040, 2041, 2046	G2090229	HZ7B1 Zener	R2039, 2045, 2048,	J02245104	" " " 100kΩ "
D2058	G2090217	HZ3C1 "	2101, 2103, 2106,		
D2068	G2090135	ND487C2-3R Quad (Ring)	2114, 2116, 2124,		
D2071, 2072	G2090118	1SS97 Schottky	2180		
			R2054	J02245124	" " " 120kΩ "
		CRYSTAL FILTER	R2187	J01215224	" " 1/8W 220kΩ TJ
XF2001	H1102107	XF45M-203-01	R2110	J02245474	" " 1/4W 470kΩ SJ
			R2130	J02245824	" " " 820kΩ "
		RESISTORS	R2117	J02245105	" " " 1MΩ "
R2145	J30376019	Cement 5W 0.1Ω	R2037	J02245225	" " " 2.2MΩ "
R2063	J02245689	Carbon Film 1/4W 6.8Ω SJ			
R2081	J02245569	" " " 5.6Ω "			POTENTIOMETERS
R2083, 2086, 2153	J02245100	" " " 10Ω "	VR2001, 2012	J51745102	H0651A 007-1KB 1kΩB
R2181	J01245220	" " " 22Ω TJ	VR2002, 2011	J51745473	H0651A 017-47KB 47kΩB
R2041, 2064	J02245470	" " " 47Ω SJ	VR2003-2005,	J51745103	H0651A 013-10KB 10kΩB
R2070	J01245470	" " " 47Ω TJ	2007, 2009		
R2007	J02245560	" " " 56Ω SJ	VR2008	J51745105	H0651A 025-1MB 1MΩB
R2044, 2047, 2057, 2068, 2082	J02245680	" " " 68Ω "	VR2010	J60800124	RK09K 1110-10KB 10kΩB
					CAPACITORS
R2019-2029, 2031, 2033, 2035, 2046, 2067, 2069, 2073-2075, 2077, 2091, 2112, 2125, 2128, 2142, 2152, 2177, 2179, 2190	J02245101	" " " 100Ω "	C2019, 2028, 2030, 2169	K00172050	Ceramic Disc 50WV 5pF SL (DD104SL050C50)
			C2020, 2021	K00173060	" " " 6pF "
					(DD104SL060D50)
			C2026, 2027	K00173090	" " " 9pF "
					(DD104SL090D50)
			C2034, 2035	K00175120	" " " 12pF "
					(DD104SL120J50)
R2030, 2032, 2034, 2036, 2050, 2058, 2060	J01245101	" " " 100Ω TJ	C2178	K02175150	" " " 15pF CH (DD104CH150J50)
R2191	J00215101	" " 1/8W 100Ω VJ	C2044, 2046	K00175180	" " " 18pF SL (DD104SL180J50)
R2052, 2092	J02245221	" " 1/4W 220Ω SJ			
R2056	J02245331	" " " 330Ω "	C2036, 2038, 2042, 2043	K00179005	" " " 20pF "
R2008, 2017, 2018, 2051, 2061, 2076, 2176, 2178, 2183, 2185	J02245471	" " " 470Ω "	C2008, 2052, 2054	K00175220	" " " 22pF "
					(DD104SL220J50)
R2053	J01245471	" " " 470Ω TJ	C2113, 2115	K00175330	" " " 33pF "
					(DD104SL330J50)
R2042, 2043, 2065, 2080	J02245681	" " " 680Ω SJ	C2022	K00175390	" " " 39pF "
					(DD104SL390J50)
R2011, 2014-2016, 2040, 2078, 2079, 2089, 2090, 2093, 2094, 2131, 2140, 2143, 2173	J02245102	" " " 1kΩ "	C2001, 2029	K00175470	" " " 47pF "
					(DD104SL470J50)
			C2050, 2051	K00179010	" " " 51pF "
					(DD104SL510J50)
R2189	J01215102	" " 1/8W 1kΩ TJ	C2114	K00175680	" " " 68pF "
					(DD104SL680J50)
R2062	J02245122	" " 1/4W 1.2kΩ SJ	C2010, 2060, 2062	K00175620	" " " 62pF "
					(DD104SL620J50)
R2132	J02245152	" " " 1.5kΩ "			
R2009, 2049, 2126	J02245222	" " " 2.2kΩ "	C2007	K00175750	" " " 75pF "
					(DD104SL750J50)
R2118	J02245332	" " " 3.3kΩ "			
R2059	J00215332	" " 1/8W 3.3kΩ VJ	C2006, 2037, 2098, 2099, 2149, 2150	K00175820	" " " 82pF "
					(DD104SL820J50)
R2002, 2010, 2149, 2154	J02245472	" " " 4.7kΩ SJ	C2045	K00179013	" " " 91pF "
					(DD105SL910J50)
R2175, 2188	J02245682	" " " 6.8kΩ "			
			C2058, 2059	K00175101	" " " 100pF "
					(DD105SL101J50)
R2004, 2012, 2013, 2038, 2072, 2100, 2102, 2104, 2105, 2109, 2113, 2115, 2119, 2123, 2129, 2134, 2139, 2144, 2182, 2184	J02245103	" " " 10kΩ "	C2053, 2068, 2070	K00179015	" " " 110pF "
					(DD105SL111J50)
			C2009, 2066, 2067, 2076, 2078	K00175151	" " " 150pF "
					(DD106SL151J50)
R2186	J01245103	" " 1/4W 10kΩ TJ	C2061	K00179019	" " " 200pF "
					(DD106SL201J50)
R2055, 2174	J01215103	" " 1/8W 10kΩ "	C2082, 2085	K00175271	" " " 270pF "
					(DD107SL271J50)
R2005	J02245153	" " 1/4W 15kΩ SJ			
R2001, 2003	J02245223	" " " 22kΩ "	C2119	K00175561	" " " 560pF "
					(DD107SL561J50)
R2096, 2136, 2138	J02245333	" " " 33kΩ "			

C2069	K00179022	Ceramic Disc 50WV360pFSL (DD108SL361J50)	L2013, 2015 L2014	L0190048 L0190042	RF3855-5R6K 5.6μH RF3855-1R8K 1.8μH
C2074, 2075, 2077	K00175471	" " " 470pF " (DD109SL471J50)	L2018, 2020 L2019	L1190161 L1190155	LHL06NA 6R8K 6.8μH LHL06NA 2R2K 2.2μH
C2083, 2084, 2111, 2112, 2129, 2138, 2151-2154, 2160	K12171102	" " " 0.001μF E (DD104E102P50)	L2021, 2022, 2034 L2024	L1190165 L1190157	LHL06NA 150K 15μH LHL06NA 3R3K 3.3μH
C2004, 2005, 2012-2015, 2017, 2023, 2025, 2031, 2033, 2039, 2041, 2049, 2057, 2065, 2073, 2081, 2088, 2090, 2102, 2103, 2105-2110, 2116, 2118, 2120-2125, 2127, 2128, 2134, 2135, 2142-2144, 2148, 2158, 2162, 2164, 2165, 2171- 2173, 2176, 2177	K13179008	" " " 0.01μF F (DD108F103Z50)	L2026, 2027 L2028, 2030 L2029 L2031, 2032 L1010, 2033, 2035-2037 L2038, 2040, 2044 L2039 L2041, 2042 L2043, 2045 L2046, 2048 L2047 L2049, 2050, 2066 L2051, 2062 L2052, 2067	L1190166 L1190168 L1190162 L1190169 L1190172 L1190174 L1190167 L1190173 L1190180 L1190177 L1190179 L1190187 L1190040	LHL06NA 180K 18μH LHL06NA 270K 27μH LHL06NA 8R2K 8.2μH LHL06NA 330K 33μH LHL06NA 560K 56μH LHL06NA 820K 82μH LHL06NA 220K 22μH LHL06NA 680K 68μH LHL06NA 271K 270μH LHL06NA 151K 150μH LHL06NA 221K 220μH LHL06NA 102K 1mH S4-102 1mH
C2002, 2047, 2055, 2063, 2071, 2079, 2086, 2089, 2092, 2100, 2101, 2130, 2132, 2137, 2139, 2140, 2145	K13179009	" " " 0.047μF F (DD110F473Z50)	L2055, 2065 L2056 L2064 L2057, 2058 L2059 L2068	L1190133 L1190159 L1190095 L0021221 L1190138 L1190135	LAL04NA 101K 100μH LHL06NA 4R7K 4.7μH LAL04NA 4R7K 4.7μH 0.17μH LAL04NA 100K 10μH LAL04NA 561K 560μH
C2093-2095, 2131	K19149021	Barrier Layer 25WV 0.047μF (UAT08X473K-L45AE)	L2069 L2053, 2070	L1190151 L1190090	LHL06NA 1R0M 1μH LAL04NA 102K 1mH
C2003, 2011, 2016, 2097, 2104, 2163	K19149025	" " " 0.1μF (UAT10X104K-L45AE)	L2071 L2072	L1190336 L1190188	LAL04NA 271K 270μH LAL03NAR22M 0.22μH
C2157	K40179010	Electrolytic 50WV 0.47μF (RE-50VR47M)			TRANSFORMERS
C2018, 2141, 2170	K40179013	" " " 1μF (RE-50V010M)	T2001 T2002	L0021605 L0020856	
C2136, 2167	K40179012	" " " 4.7μF (RE-50V4R7M)	T2003, 2008, 2009 T2004-2007	L0020788A L0021225	R12-6707A 47.1MHz
C2024, 2032, 2040, 2048, 2056, 2064, 2072, 2080, 2087, 2133, 2155, 2159	K40179014	" " " 10μF (RE-50V100M)			FERRITE BEADS L9190001 R13X3-1
C2091	K40179022	" " " 22μF (RE-50V220M)	RL2001 RL2002	M1190067 M1190056	RELAYS G5A-237P DC 12V FBR21D12 "
C2175	K40129016	" " 16WV 22μF (RE-16V220M)	RL2003	M1190068	G6E-134P "
C2096	K40129008	" " " 33μF (RE-16V330M)			LAMP FUSE
C2156	K70167224	Tantalum 50WV 0.22μF (DN1VR22MIS)	F2001	Q1000010	BQ041-22803A
	K70167474	" " " 0.47μF (DN1VR47MIS)	S2001 S2002	N4090101 N6090033	SWITCHES SPJ-2E SSS-21200
C2168	K70127106	" " 16WV 10μF (DN1C100MIS)			CONNECTORS
C2166	K80000003	Capacitor Block 7x 0.01μF (CA1037)	J2001-2005 J2006-2011 J2012, 2020, 2021 J2013	P1090348 P1090255 P0090197 P0090200	S-Q 3097-01 TMP-JA B08B-XH-A B11B-XH-A
L2001, 2004, 2054, 2060, 2063	L1190175	LHL06NA 101K 100μH	J2014, 2023, 2025, 2030-2032	P0090192	B03B-XH-A
L2002	L0021221	0.17μH	J2015, 2022, 2024	P0090191	B02B-XH-A
L2003	L0021222	0.24μH	J2016	P0090194	B05B-XH-A
L2005, 2006	L0190047	RF3855-4R7K 4.7μH	J2017	P0090207	S06B-XH-A
L2007, 2009	L0190045	RF3855-3R3K 3.3μH	J2018	P1090419	3024-06CH
L2008	L0190039	RF3855-1R0K 1μH	J2019	P1090250	3024-08CH
L2016, 2017, 2023, 2025	L1190163	LHL06NA 100K 10μH	J2026 J2027, 2028	P0090196 P0090193	B07B-XH-A B04B-XH-A
L2011, 2012	L0190050	RF3855-8R2K 8.2μH	J2029	P0090195	B06B-XH-A

	R5047911B	HEATSINK	1102-1109, 1113-1115, 1118-1120, 1124-1131, 1133, 1134, 1136, 1138, 1140, 1141		
		TERMINALS			
	Q5000050	TP-K			
IF UNIT					
Symbol No.	Part No.	Name & Description			CRYSTAL
	F2783000B	Printed Circuit Board	X1001	H0102550	HC-18/u 8.67MHz
	C027830AA	PCB with Components			
		ICs			CRYSTAL FILTERS
Q1007	G1090389	MC3359P	XF1001	H1102050	8.2M20A
Q1017, 1036, 1070	G1090686	LA6458S	XF1002	H1102079	XF-8.2M601-01 (CW)
Q1037	G1090494	MB3713M-G	XF1003	H1102080	XF-8.2M272-01 (SSB)
Q1038, 1055	G1090257	MC14066BCP			
Q1051, 1052, 1054	G1090101	μPC 1037H			
Q1053	G1090413	TA7302P	CF1001	H3900200	CERAMIC FILTERS CFW 455E
Q1059	G1090531	TMS1751C (M47003)	CF1002	H3900340	LF-H6S
Q1060	G1090052	MC14049UBCP	CF1003	H3900378	LF-E2A
		FETs			
Q1001, 1002, 1009, 1012, 1016, 1025, 1050	G4800740L	3SK74L			CERAMIC RESONATOR
			CO1001	H7900140	CSA 1.000MK
					RESISTORS
Q1005, 1006, 1018, 1048, 1049, 1076, 1077	G3801040J	2SK104J	R1407	J01275279	Carbon Film 1/2W 2.7Ω TJ
			R1153, 1342	J02245100	" " 1/4W 10Ω SJ
			R1341, 1353	J02245560	" " " 56Ω "
Q1008	G3802410G	2SK241GR	R1125, 1161, 1220	J02245680	" " " 68Ω "
Q1011, 1031	G3801921G	2SK192A-GR	R1004, 1005, 1007, 1009, 1010, 1017, 1022, 1029, 1046, 1057, 1061, 1070, 1072, 1073, 1083, 1087, 1091, 1117, 1126, 1137, 1146, 1155, 1156, 1160, 1163, 1166, 1195, 1204, 1205, 1250, 1254, 1255, 1260, 1272, 1292, 1332, 1338, 1380, 1390, 1391, 1396	J02245101	" " " 100Ω "
		TRANSISTORS			
Q1003, 1004, 1013-1015, 1019, 1020 1022-1024, 1026-1030, 1056-1058, 1064-1069, 1071-1073	G3309451Q	2SC945AQ			
Q1010, 1061, 1063	G3107331P	2SA733AP			
Q1021	G3319230O	2SC1923O			
Q1033-1035, 1074	G3090068	2SC458LGC			
Q1039-1047, 1079	G3090075	BN1A4P			
Q1062, 1075	G3090074	BA1A4M	R1028, 1048, 1064	J01245101	" " " 100Ω TJ
Q1078	G3406670C	2SD667C	R1032, 1214, 1348, 1394	J02245151	" " " 150Ω SJ
		DIODES			
D1001, 1002, 1058, 1059, 1121, 1137	G2090244	1SS106 Schottky	R1030	J01245151	" " " 150Ω TJ
			R1026, 1050, 1090, 1154, 1173, 1183, 1268, 1269, 1277, 1286, 1288, 1290, 1291, 1349	J02245221	" " " 220Ω SJ
D1013, 1015, 1017-1020, 1101, 1142, 1143	G2090118	1SS97 "			
	G2090217	HZ3C1 Zener			
D1036	G2090180	FC53-M5 Varactor	R1144	J01245221	" " " 220Ω TJ
D1037	G2090220	ND487R1-3R Quad (Ring)	R1053, 1181, 1303, 1351, 1370, 1375	J02245331	" " " 330Ω SJ
D1042, 1049	G2090226	HZ4C3 Zener			
D1055	G2090023	1SV50 Varactor	R1027, 1044, 1049		
D1057, 1122, 1123	G2090340	1SS83 Si	1059, 1075, 1092, 1165, 1168, 1282, 1378	J02245471	" " " 470Ω "
D1060, 1111, 1112, 1116, 1117	G2001880F	1S188FM1 Ge			
D1063, 1110	G2090111	HZ6C1 Zener	R1415	J01245561	" " " 560Ω TJ
D1132	G2090188	HZ5C1 "	R1129, 1222, 1265	J02245561	" " " 560Ω SJ
D1135	G2090217	HZ3C1 "	R1056, 1066, 1147, 1158, 1253, 1344	J02245681	" " " 680Ω "
D1003, 1006-1012, 1014, 1016, 1021-1035, 1041, 1043-1048, 1050, 1051, 1053, 1054, 1056, 1061, 1064-1091, 1094-1100,	G2090027	1SS53 Si	R1408 R1001, 1011, 1016, 1019, 1020, 1037, 1047, 1058, 1067, 1076, 1082, 1100, 1119, 1120, 1124, 1140, 1143, 1150,	J01215102 J02245102	" " 1/8W 1kΩ TJ " " 1/4W 1kΩ SJ

1171, 1178, 1187, 1188, 1206, 1213, 1218, 1257, 1258, 1263, 1271, 1273, 1280, 1284, 1296, 1309, 1318, 1354, 1366, 1374, 1383, 1385, 1395, 1398, 1418			1112, 1148, 1164, 1167, 1169, 1175, 1177, 1221, 1227, 1229, 1276, 1278, 1283, 1305, 1328, 1343, 1345, 1371		
R1337	J02245122	Carbon Film 1/4W 1.2kΩ "	R1267	J02245563	" " " 56kΩ "
R1040, 1099, 1162	J02245152	" " " 1.5kΩ "	R1071, 1184, 1201, 1308, 1319, 1335, 1358	J02245683	" " " 68kΩ "
R1014, 1094, 1198, 1199, 1274, 1294, 1307, 1316, 1346, 1347, 1369, 1373, 1379, 1416, 1417	J02245222	" " " 2.2kΩ "	R1080	J02245823	" " " 82kΩ "
R1298	J01245222	" " " 2.2kΩ TJ	R1002, 1036, 1045, 1052, 1081, 1084, 1106, 1108, 1114, 1118, 1136, 1145, 1151, 1157, 1176, 1226, 1259, 1264, 1295, 1304, 1311, 1325, 1339, 1363, 1365, 1377, 1386, 1397	J02245104	" " " 100kΩ "
R1060, 1062, 1063, 1065, 1121, 1159, 1172, 1186, 1203, 1306, 1326	J02245272	" " " 2.7kΩ SJ	R1051, 1197, 1212, 1275, 1279, 1281, 1364	J02245154	" " " 150kΩ "
R1224	J02245332	" " " 3.3kΩ "	R1033	J01245154	" " " 150kΩ TJ
R1024, 1034, 1098, 1122, 1141, 1207, 1215, 1251, 1285, 1299, 1302, 1330, 1333, 1340, 1389, 1393, 1413, 1419	J01215392	" " 1/8W 3.9kΩ TJ	R1079	J02245224	" " " 220kΩ SJ
R1405	J02245472	" " 1/4W 4.7kΩ "	R1412	J01215224	" " 1/8W 220kΩ TJ
R1093, 1217, 1334, 1336	J01215472	" " 1/8W 4.7kΩ TJ	R1038, 1105, 1331	J02245334	" " 1/4W 330kΩ SJ
R1023, 1115, 1193, 1194, 1196, 1209-1211	J02245562	" " 1/4W 5.6kΩ SJ	R1101	J02245474	" " " 470kΩ "
R1003, 1006, 1008, 1012, 1013, 1015, 1018, 1035, 1042, 1069, 1077, 1085, 1088, 1102-1104, 1109-1111, 1128, 1130-1133, 1139, 1149, 1152, 1170, 1174, 1189, 1192, 1208, 1216, 1225, 1230, 1231, 1266, 1287, 1293, 1312-1315, 1323, 1324, 1329, 1355, 1356, 1359, 1360, 1362, 1367, 1368, 1372, 1381, 1392, 1402, 1403	J02245682	" " " 6.8kΩ "	R1219	J01245474	" " " 470kΩ TJ
R1406, 1410	J02245103	" " " 10kΩ "	R1074	J02245824	" " " 820kΩ SJ
R1078, 1411	J01245103	" " 1/4W 10kΩ "	R1310	J02245105	" " " 1MΩ "
R1039, 1252, 1256, 1352	J02245153	" " " 15kΩ SJ	R1409	J01215105	" " 1/8W 1MΩ TJ
R1055	J02245183	" " " 18kΩ "	R1116	J02245155	" " " 1.5MΩ SJ
R1123, 1127, 1138, 1142, 1202, 1232, 1234, 1270, 1317, 1320, 1350, 1376, 1399	J02245223	" " " 22kΩ "	R1228	J02245225	" " " 2.2MΩ "
R1233	J02245273	" " " 27kΩ "	R1361	J02245335	" " " 3.3MΩ "
R1041, 1068, 1086, 1113, 1179, 1301	J02245333	" " " 33kΩ "			
R1021, 1043, 1054,	J02245473	" " " 47kΩ "			
					POTENTIOMETERS
			VR1001, 1014, 1019	J51745104	H0651A 019-100KB 100kΩ B
			VR1002, 1005, 1007, 1009, 1012, 1016	J51745103	H0651A 013-10KB 10kΩ B
			VR1003, 1013	J51745473	H0651A 017-47KB 47kΩ B
			VR1004	J51745105	H0651A 025-1MB 1MΩ B
			VR1006, 1015	J51745472	H0651A 011-4.7KB 4.7kΩ B
			VR1008	J51745102	H0651A 007-1KB 1kΩ B
			VR1017	J60800126	RK09K1110-500KB 500kΩ B
			VR1018	J60800124	RK09K1110-10KB 10kΩ B
					THERMISTORS
			TH1001	G9090002	D22A
			TH1002	G9090016	112252-2
			TH1003	G9090012	SDT500
					CAPACITORS
			C1106	K06172030	Ceramic disc 50WV 3pF UJ (DD104UJ 030C50)
			C1189	K00172050	" " " 5pF SL (DD104SL 050C50)
			C1032, 1034, 1288, 1309, 1310	K00173100	" " " 10pF " (DD104SL 100D50)
			C1009, 1115, 1203	K00175220	" " " 22pF " (DD104SL 220J50)
			C1102, 1104, 1119, 1139	K00175330	" " " 33pF " (DD104SL 330J50)
			C1096, 1113, 1295	K00175470	" " " 47pF " (DD104SL 470J50)

C1136	K00175680	Ceramic disc 50WV 68pF SL (DD104SL 680J50)	C1087, 1162, 1164, 1253	K50177103	" " " 0.01μF (50F2U103M)
C1001, 1023, 1047, 1053, 1085, 1112, 1117, 1129, 1235, 1284	K00175101	" " " 100pF " (DD105SL 101J50)	C1169, 1170	K50177153	" " " 0.015μF (50F2U153M)
C1233	K00175121	" " " 120pF " (DD105SL 121J50)	C1099, 1143, 1163, 1223-1225, 1244, 1245, 1259, 1261	K50177223	" " " 0.022μF (50F2U223M)
C1005, 1046, 1131	K00175151	" " " 150pF " (DD106SL 151J50)	C1239	K50177273	" " " 0.027μF (50F2U273M)
C1011, 1013	K00179019	" " " 200pF " (DD106SL 201J50)	C1042	K50177683	" " " 0.068μF (50F2U683M)
C1107-1109	K06179018	" " " 330pF UJ (DD110UJ 331J50)	C1182	K40179016	Electrolytic 50WV 0.1μF (RE-50V 0R1M)
C1211	K00175471	" " " 470pF " (DD109SL 471J50)	C1058	K40179026	" " " 0.22μF (RE-50V R22M)
C1017, 1018, 1097, 1128, 1142, 1180, 1185, 1186, 1237, 1238, 1240, 1257, 1265, 1267-1269, 1282, 1294	K12171102	" " " 0.001μF E (DD104E 102P50)	C1285, 1287	K40179005	" " " 0.47μF (RE-50V R47M)
C1002-1004, 1006- 1008, 1010, 1015, 1016, 1019, 1021, 1022, 1024-1031, 1033, 1035, 1049- 1051, 1054, 1057, 1059, 1061, 1063, 1066, 1073, 1074, 1077-1079, 1083, 1100, 1101, 1103, 1105, 1110, 1111, 1116, 1120, 1122- 1124, 1127, 1132, 1134, 1135, 1137, 1141, 1183, 1184, 1187, 1188, 1190- 1197, 1199, 1202, 1207, 1230, 1236, 1241, 1247, 1264, 1281, 1291, 1296, 1297, 1299, 1305	K13179008	" " " 0.01μF F (DD106F 103Z50)	C1140, 1144, 1147, 1149, 1200, 1213, 1215, 1229, 1243, 1246, 1249-1252, 1266, 1270, 1277, 1278, 1289	K40179013	" " " 1μF (RE-50V 010M)
			C1234, 1271	K40179009	" " " 2.2μF (RE-50V 2R2M)
			C1036, 1150-1152, 1157, 1159, 1161, 1166, 1167, 1171, 1181, 1208, 1220, 1226, 1231, 1242, 1255, 1258, 1260, 1275, 1293	K40179012	" " " 4.7μF (RE-50V 4R7M)
			C1012, 1014, 1041, 1048, 1125, 1148, 1165, 1174, 1198, 1227, 1248, 1254, 1262, 1263, 1274, 1276, 1279, 1280, 1292, 1298, 1308	K40179014	" " " 10μF (RE-50V 100M)
				K40129004	" " " 16WV 10μF (RE-16V 100M)
			C1168	K40129012	" " " 10μF (RC2-16V 100M)
C1020, 1055, 1056, 1060, 1062, 1064, 1065, 1067-1072, 1080-1082, 1084, 1086, 1088, 1090, 1091, 1098, 1121, 1130, 1201, 1204, 1205, 1210, 1216-1219, 1272, 1273, 1301	K13179009	" " " 0.047μF " (DD110F 473Z50)	C1093, 1118, 1146, 1154, 1160, 1256, 1307	K40149025	" " " 25WV 22μF (RE-25V 220M)
			C1126	K40109002	" " " 10WV 47μF (RE-10V 470M)
			C1175	K40149022	" " " 25WV 47μF (RE-25V 470M)
			C1089, 1179	K40149003	" " " 100μF (RE-25V 101M)
			C1172, 1176	K40129031	" " " 16WV 470μF (RC-16V 471M)
C1037, 1173, 1177, 1209, 1214, 1221, 1222, 1283	K19149021	Barrier Layer 25WV 0.047μF (UAT08X 473K-L45AE)	C1094	K70167224	Tantalun 35WV 0.22μF (DN1VR22MIS)
C1038, 1044, 1045, 1052, 1178,	K19149025	" " " 0.1μF (UAT10X 104K-L45AE)	C1302	K70167474	" " " 0.47μF (DN1V R47MIS)
C1075, 1076	K51176102	Polyester 50WV 0.001μF (50SU102K)	C1303	K70167684	" " " 0.68μF (DN1V R68MIS)
C1039, 1040, 1153, 1228	K50170007	Mylar 50WV 0.001μF (50F2U102M)	C1304	K70107475	" " " 4.7μF (DN1A 4R7MIS)
C1138, 1155, 1158	K50177222	" " " 0.0022μF (50F2U222M)			INDUCTORS
C1156	K50177472	" " " 0.0047μF (50F2U472M)	L1001, 1009, 1010, 1015, 1018	L1190187	LHL06NA 102K 1mH
			L1002-1006, 1012, 1017, 1022, 1023	L1190177	LHL06NA 151K 150μH

X3002	H0102556A	HC-18/U	6.7866MHz	3184, 3186, 3195,		
X3003	H0102700	"	6.7834MHz	3197, 3199, 3217,		
X3004	H0102701	"	6.7841MHz	3218, 3233, 3256		
X3005	H0102702	"	6.7872MHz	R3225	J02245272	" " " 2.7kΩ "
X3007	H0102554A	"	15.000MHz	R3138, 3140, 3142,	J02245332	" " " 3.3kΩ "
X3008	H0102553B	"	15.0007MHz	3144, 3146, 3226,		
				3242		
				R3065, 3099, 3206,	J02245472	" " " 4.7kΩ "
		CRYSTAL-OSC UNIT		3224, 3247, 3251,		
	H9500060	H-GF1502	15MHz	3260, 3261, 3282,		
				3284, 3286, 3288		
				R3020, 3237, 3290	J02245562	" " " 5.6kΩ "
		CERAMIC RESONATORS		R3208	J02245682	" " " 6.8kΩ "
CO3001	H7900290	R6.0M	6MHz	R3010, 3018, 3019,	J02245103	" " " 10kΩ "
CO3002	H7900350	R580C	580kHz	3041, 3050, 3058,		
				3117, 3126,		
				3149-3151, 3155,		
		BUZZER		3157, 3161-3163,		
BZ3001	M4290001	EFBRE-25D02		3167-3169, 3177,		
				3179, 3181, 3183,		
				3185, 3187, 3192,		
				3196, 3198, 3200,		
		RESISTORS		3211, 3213, 3215,		
R3013, 3037, 3049,	J02245470	Carbon Film 1/4W	47Ω SJ	3220, 3222, 3231,		
3204				3235, 3245, 3246,		
R3075, 3191	J02245680	" " "	68Ω "	3248, 3259,		
R3012, 3016, 3021,	J02245101	" " "	100Ω "	3264-3268, 3274,		
3024, 3026-3029,				3276, 3281, 3283,		
3031, 3034, 3035,				3285, 3287, 3289,		
3040, 3045, 3048,				3293-3296		
3052, 3061, 3063,				R3209, 3255, 3257	J01245103	" " " 10kΩ TJ
3068, 3070-3072,				R3303, 3304	J01215103	" " " 1/8W 10kΩ "
3077, 3080, 3091,				R3156, 3207, 3262	J02245153	" " " 1/4W 15kΩ SJ
3095, 3098, 3101,				R3017, 3022, 3043,	J02245223	" " " 22kΩ "
3103, 3105, 3112,				3051, 3059, 3074,		
3148, 3154, 3160,				3086, 3137, 3139,		
3166, 3193, 3194,				3141, 3143, 3145,		
3201, 3202, 3223,				3153, 3159, 3165,		
3234, 3239, 3279,				3171, 3230		
3292				R3205, 3238	J02245333	" " " 33kΩ "
R3291	J01245101	" " "	100Ω TJ	R3002, 3011, 3032,	J02245473	" " " 47kΩ "
R3110	J02245151	" " "	150Ω SJ	3055, 3066, 3100,		
R3089, 3113-3116,	J02245221	" " "	220Ω "	3188-3190, 3210,		
3118-3125,				3212, 3214, 3216,		
3127-3130,				3232, 3263, 3277,		
3172-3175, 3240,				3301, 3302		
3241				R3014, 3038, 3054,	J02245104	" " " 100kΩ "
R3079, 3088, 3249	J02245331	" " "	330Ω "	3056, 3062, 3078,		
R3046	J02245391	" " "	390Ω "	3081, 3087, 3092,		
R3023, 3033, 3036,	J02245471	" " "	470Ω "	3096, 3106, 3108,		
3039, 3042, 3044,				3131, 3134, 3152,		
3057, 3060, 3064,				3158, 3164, 3170,		
3067, 3069, 3076,				3203, 3219, 3236,		
3083, 3093, 3097,				3252-3254, 3275,		
3102, 3104, 3109,				3278, 3297		
3133, 3221, 3229,				R3147	J02245124	" " " 120kΩ "
3273, 3280				R3269	J02245274	" " " 270kΩ "
R3073, 3084, 3107,	J02245681	" " "	680Ω "	R3008	J02245105	" " " 1MΩ "
3244, 3250					J02245155	" " " 1.5MΩ "
R3015, 3025, 3030,	J02245102	" " "	1kΩ "	R3006	J02245225	" " " 2.2MΩ "
3047, 3082, 3090,						
3094, 3111, 3135,						
3136, 3227, 3228,						
3258, 3300						
R3085	J02245152	" " "	1.5kΩ "			
R3132	J02245182	" " "	1.8kΩ "			BLOCK RESISTORS
R3009, 3053, 3176,	J02245222	" " "	2.2kΩ "	RB3001	J40900044	EXB-R87 103K 10KΩ×7
3178, 3180, 3182,				RB3002	J40900050	EXB-P86 473K 47KΩ×6

RB3003-3005	J40900023	DA-2	C3134, 3136, 3147, 3158	K00175150	" " 15pF "	(DD104SL150J50)
			C3028, 3037, 3040, 3055, 3082, 3211	K00175180	" " 18pF "	(DD104SL180J50)
		POTENTIOMETERS				
VR3001	J51760104	GF06P 100kΩB	C3056, 3078, 3095	K00175220	" " 22pF "	(DD104SL220J50)
VR3002	J51769222	PK502H222H0 2.2kΩB				
VR3003	J51745223	H0651A015-22KB 22kΩB	C3051, 3052	K00175270	" " 27pF "	(DD104SL270J50)
			C3135	K00175330	" " 33pF "	(DD104SL330J50)
		CAPACITORS				
C3103	K02179001	Ceramic disc 50WV 1pF CH (DD104CK010C50)	C3038, 3039	K00179008	" " 36pF "	(DD104SL360J50)
C3102	K02179005	" " " 1.5pF " (DD104CK1RC50)	C3096	K00175390	" " 39pF "	(DD104SL390J50)
C3003	K02172040	" " " 4pF " (DD104CH040C50)	C3091, 3222	K00175560	" " 56pF "	(DD104SL560J50)
C3071	K02173080	" " " 8pF " (DD104CH080J50)	C3042, 3208	K00175620	" " 62pF "	(DD104SL620J50)
C3107, 3231	K02175150	" " " 15pF " (DD104CH150D50)	C3251, 3252	K00175680	" " 68pF "	(DD104SL680J50)
C3062, 3063, 3065	K02175220	" " " 22pF " (DD104CH220J50)	C3094	K00179013	" " 91pF "	(DD105SL910J50)
C3064	K02175390	" " " 39pF " (DD105-257CH390J50)	C3092, 3120, 3224, 3225, 3257	K00175101	" " 100pF "	(DD105SL101J50)
	K02179025	" " " 220pF " (DD111CH221J50)	C3041, 3043, 3138	K00175121	" " 120pF "	(DD105SL121J50)
C3075, 3076	K02179027	" " " 270pF " (DD112CH271J50)	C3258	K00175151	" " 150pF "	(DD106SL151J50)
C3173, 3175, 3179, 3181, 3187, 3193	K06172050	" " " 5pF UJ (DD104UJ050C50)	C3140, 3141, 3144, 3145, 3149-3156, 3160-3163	K00175221	" " 220pF "	(DD107SL221J50)
C3008, 3180, 3185, 3191	K06175150	" " " 15pF " (DD104UJ150J50)	C3106	K05175560	" " 56pF RH	(DD106RH560J50)
C3174	K06175180	" " " 18pF " (DD104UJ180J50)	C3010-3012, 3117, 3169, 3170, 3195, 3196	K12171102	" " 0.001μF E	(DD104E102P50)
C3186	K06175220	" " " 22pF " (DD104UJ220J50)	C3001, 3002, 3004, 3007, 3009, 3013, 3014, 3016-3021, 3026, 3027, 3029-3036, 3044-3046, 3049, 3050, 3053, 3054, 3057-3061, 3066-3070, 3072-3074, 3077, 3079, 3083, 3084, 3086, 3087, 3089, 3098, 3100, 3101, 3105, 3110, 3114-3116, 3118, 3119, 3121, 3123, 3124, 3126-3133, 3137, 3139, 3142, 3146, 3157, 3172, 3178, 3184, 3190, 3197, 3202-3206, 3209, 3210, 3212, 3213, 3216, 3218, 3220, 3221, 3223, 3226, 3227, 3230, 3232-3234, 3236, 3239-3247, 3261-3265	K13179008	" " 0.01μF F	(DD106F103Z50)
C3108	K06175270	" " " 27pF " (DD104UJ270J50)				
C3109, 3176, 3182, 3192	K06175330	" " " 33pF " (DD104UJ330J50)				
C3188	K06179009	" " " 56pF " (DD105UJ560J50)				
C3194	K06175820	" " " 82pF " (DD106UJ820J50)				
C3005, 3006	K06175101	" " " 100pF " (DD106UJ101J50)				
C3085, 3125	K00179001	" " " 0.5pF SL (DD104SL0R5C50)				
C3088	K00172010	" " " 1pF " (DD104SL010C50)				
C3102	K00175159	" " " 1.5pF " (DD104SL1R5C50)				
C3022-3025, 3047, 3214	K00172020	" " " 2pF " (DD104SL020C50)				
C3081, 3090, 3228	K00172040	" " " 4pF " (DD104SL040C50)				
C3048, 3199, 3200	K00172050	" " " 5pF " (DD104SL050C50)				
C3080, 3122	K00173060	" " " 6pF " (DD104SL060D50)				
C3266	K00173080	" " " 8pF " (DD104SL080D50)				
C3219	K00173100	" " " 10pF " (DD104SL100D50)				
C3093	K00175120	" " " 12pF " (DD104SL120J50)	C3015, 3097, 3197, 3202, 3217	K13179010	" " 0.022μF "	(DD108F228Z50)

C3256	K13179009	Ceramic 50WV 0.047 μ F F (DD110F473Z50)	T3020, 3021 T3022	L0021399 L0021599	0.42 μ H
C3165	K19149009	Barrier Layer 25WV 0.0047 μ F (UAT05X472K-L45AE)	T3023, 3024	L0021199	R12-4043A 8.20MHz
C3113, 3167	K19149013	" " " 0.01 μ F (UAT05X103K-L45AE)		L9190016	07MM
C3248, 3259, 3260, 3267	K19149025	" " " 0.1 μ F (UAT10X104K-L45AE)			
C1112, 1166	K40179010	Electrolytic 50WV 0.47 μ F (RE-50VR47M)	S3001	N6090037	SWITCHES SSS-312
C1143, 3164, 3168, 3229, 3237, 3254	K40179013	" " " 1 μ F (RE-50V010M)	S3002-3004	N4090012	SPJ-22-A01
C3250	K40179009	" " " 2.2 μ F (RE-50V2R2M)			CONNECTORS
C3207, 3249	K40179011	" " " 3.3 μ F (RE-50V3R3M)	J3001-3005 J3006	P1090255 P1090296	TMP-JA S-Q3097-02
C3099, 3148, 3159, 3215, 3235	K40179014	" " " 10 μ F (RE-50V100M)	J3007	P1090354	S-Q3097-04
C3171, 3177, 3183, 3189, 3238	K40129008	" 16WV 33 μ F (RE-16V330M)	J3008, 3009, 3020, 3021, 3025	P00090191	B02B-XH-A
C3104	K40109002	" 10WV 47 μ F (RE-10V470M)	J3010, 3022, 3029	P0090192	B03B-XH-A
C3111	K40109001	" " 100 μ F (RE-10V101M)	J3011, 3012, 3030 J3013, 3016, 3023 J3014, 3017, 3018 J3015 J3019 J3024, 3026	P0090196 P0090193 P0090194 P0090202 P0090200 P0090197	B07B-XH-A B04B-XH-A B05B-XH-A B13B-XH-A B11B-XH-A B08B-XH-A
		TRIMMER CAPACITORS	J3027	P1090423	TCS4460-01-111
TC3001, 3005	K91000093	CTZ51F118 30pF	J3028	P1090521	TCS4490-01-1111
TC3002, 3003, 3004, 3007, 3008, 3009	K91000086	CTZ51E117 20pF			TERMINAL POSTS
	K91000085	CTZ51C122 10pF		Q5000050	TP-K
	K91000108	CTZ51A157 6pF			
		BLOCK CAPACITOR	BAT3001	Q9000248	BATTERY CR-1/3N-P
CB3001	K80000007	1038Z 0.01 μ FX8		R0114910 R0114920	Shield Case Shield Cover
		INDUCTORS			
L3013	L1190151	LHL06NA1R0M 1 μ H			
L3008	L1190155	LHL06NA2R2M 2.2 μ H			
L3002-3004	L1190157	LHL06NA3R3M 3.3 μ H			
L3006, 3007	L1190160	LHL06NA5R6K 5.6 μ H			
L3021, 3022	L1190163	LHL06NA100K 10 μ H			
L3010	L1190134	S4-180K 18 μ H	Symbol No.	Part No.	Name & Description
L3001	L1190167	LHL06NA220K 22 μ H		F2784000A C027840A	Printed Circuit Board PCB with Components
L3011, 3012	L1190147	S4-270K 27 μ H			
L3007, 3023, 3030, 3031	L1190175	LHL06NA101K 100 μ H			DIODES
L3024, 3025, 3027	L1190177	LHL06NA151K 150 μ H	D6101-6104	G2090244	1SS106 Schottky
L3028, 3029, 3032	L1190221	LAL03NA181K 180 μ H	D6105-6112	G2015550	1S1555 Si
L3014-3018, 3020	L1190184	LHL06NA561K 560 μ H			
L3009	L0021410	" 0.147 μ H			
L3019	L0020332A	R12-1255X 5.25MHz			SURGE ABSORBER
L3026	L0021206B		D6113	Q9000375	DSP201-S00B
		TRANSFORMERS			RESISTORS
T3001, 3008	L0020788A		R6101, 6102	J02245220	Carbon film 1/4W 22 Ω SJ
T3002-3004, 3012, 3013, 3017, 3018	L0020909	46.3MHz			
T3005-3007, 3014, 3015	L0021390	58.1125MHz			CAPACITORS
T3009-3011	L0021609	36.8MHz	C6142-6145, 6155	K13179008	Ceramic 50WV 0.01 μ F F (DD106F103Z50)
T3016	L0021205	0.70 μ H	C6146-6154	K13179009	" " 0.047 μ F "
T3019	L0021401	0.28 μ H			(DD110F473Z50)

C6119, 6133	K00275100	Ceramic 500WV 10pF SL (DD06SL100D500)	L6107	L0021228	0.780μH
			L6108	L0021229	0.920μH
C6134, 6139	K00275120	" " 12pF " (DD06SL 120J500)	L6109	L0020854	0.590μH
			L6110	L0020855	0.700μH
C6128	K00275180	" " 18pF " (DD06SL180J500)	L6111	L0020621	0.370μH
			L6112	L0020622	0.440μH
C6137	K00275330	" " 33pF " (DD09SL330J500)	L6113	L0020623	0.250μH
			L6114	L0020624	0.310μH
C6117, 6131	K00275360	" " 36pF " (DD06SL360J500)	L6115	L0021347	
			L6116, 6117	L1190017	FL5H102K 1mH
C6126	K00275510	" " 51pF " (DD09SL510J500)			
	K00275680	" " 68pF " (DD09SL680J500)			RELAYS
			RL6101-6114	M1190045	AG2013 12V
C6121, 6140	K00275750	" " 75pF " (DD09SL750J500)	RL6115	M1190005	NR-HD-12V AE5343
C6112	K00275820	" " 82pF " (DD09SL820J500)			CONNECTORS
	K00275101	" " 100pF " (DD09SL101J500)	J6101, 6102, 6103	P1090255	TMP-JA
			J6105	P0090191	B2B-XH-A
C6115, 6135	K00275111	" " 110pF " (DD09SL111J500)	J6106	P0090193	B4B-XH-A
			J6107	P0090192	B3B-XH-A
C6125, 6130, 6138	K00275151	" " 150pF " (DD10SL151J500)			
C6123	K30275270	Dipped Mica " 27pF (LCQ12270J5)	P6101	T9205243A	
C6136	K30275121	" " 120pF (LCQ17121J5)	P6102	T9315913A	
C6103	K30275161	" " 160pF (LCQ17161J5)			
C6129	K30275181	" " 180pF (LCQ17181J5)			
			CONTROL UNIT		
C6120, 6132	K30275221	" " 220pF (LCQ17221J5)	Symbol No.	Part No.	Name & Description
				F2785101A	Printed Circuit Board
C6110	K30275241	" " 240pF (LCQ17241J5)		C027851AA	PCB with Components
C6124	K30275271	" " 270pF (LCQ17271J5)			ICs
C6114, 6127	K30275331	" " 330pF (LCQ17331J5)	Q4001	G1090720	TA78009AP
			Q4003	G1090294	μPC7808H
C6118	K30275361	" " 360pF (LCQ17361J5)	Q4012, 4013	G1090649	M5218L
C6141	K30275431	" " 430pF (LCQ18431J5)			TRANSISTORS
C6102, 6106, 6108, 6122	K30275471	" " 470pF (LCQ17471J5)	Q4004, 4005, 4007	G3104960Y	2SA496Y
			Q4006	G3110120Y	2SA1012Y
C6109	K30275561	" " 560pF (LCQ18561J5)	Q4008-4011, 4014, 4016-4018	G3309450Q	2SC945AQ
C6105, 6113, 6116	K30275681	" " 680pF (LCQ18681J5)	Q4015, 4019	G3107330P	2SA733AP
C6107	K30275821	" " 820pF (LCQ18821J5)			DIODES
C6101	K30275102	" " 1000pF (LCQ21102J5)	D4001-4018	G2090027	1SS53 Si
C6104, 6111	K30279095	" " 1200pF (DM19122J5)			RESISTORS
			R4008, 4020, 4036, 4041	J02245102	Carbon film 1/4W 1kΩ SJ
		TRIMMER CAPACITOR			
TC6101	K91000012	ECV-1ZW10X32 10pF	R4002, 4004, 4010	J02245222	" " " 2.2kΩ "
			R4001, 4003, 4007, 4009, 4012, 4022, 4024, 4031, 4032, 4043	J02245472	" " " 4.7kΩ "
		INDUCTORS			
L6101	L0021405	T50-2 3.770μH			
L6102	L0021406	" 2.940μH			
L6103	L0020615	" 1.900μH	R4014	J02245682	" " " 6.8kΩ "
L6104	L0021433	" 2.400μH			
L6105	L0020617	T50-6 1.100μH	R4005, 4006, 4011, 4013, 4017, 4018, 4023, 4025-4027,	J02245103	" " " 10kΩ "
L6016	L0020618	" 1.320μH			

4029, 4030, 4033, 4035, 4037, 4038, 4042, 4044, 4045			D7014	G2090363	LT-9002N	LED
			D7015-7018	G2090267	SG238D	"
			D7019	G2090349	LT-9200N	"
R4034	J02245473	" " " 47kΩ "	D7020	G2090348	LT-9200H	"
R4021	J02245104	" " " 100kΩ "	D7021	G2090347	LT-9200D	"
R4016, 4028, 4040	J02245224	" " " 220kΩ "	D7009, 7010	G2090118	1SS97	Schottky
R4015	J02245334	" " " 330kΩ "				
R4019, 4039	J02245564	" " " 560kΩ "				CERAMIC RESONATOR
			CO7001	H7900150	CSB500E	
		CAPACITORS				
C4003, 4008, 4010	K13179008	Ceramic 50WV 0.01μF F (DD106F103Z50)			FCD	
C4001	K13179009	" " " 0.047μF " (DD110F473Z50)	DS7001	G6090059	FIP14CM9	
						RESISTORS
C4016	K50177103	Mylar " 0.01μF (50F2U103M)	R7025	J02245101	Carbon film 1/4W 100Ω	SJ
C4011, 4012, 4014, 4015	K50177223	" " 0.022μF (50F2U223M)	R7040, 7051	J02245471	" " " 470Ω "	
C4013	K40179026	Electrolytic " 0.22μF (RE-50VR22M)	R7064	J00215471	" " 1/8W 470Ω	VJ
C4004, 4005, 4009, 4017	K40179014	" " 10μF (RE-50V100M)	R7030, 7067	J02245561	" " 1/4W 560Ω	SJ
C4002	K40149003	" 25WV 100μF (RE-25V101M)	R7050, 7054, 7057, 7058, 7061, 7070	J02245102	" " " 1kΩ "	
			R7026	J02245152	" " " 1.5kΩ "	
			R7033, 7038	J02245222	" " " 2.2kΩ "	
			R7029	J02245332	" " " 3.3kΩ "	
			R7003, 7008, 7013, 7018, 7047	J02245562	" " " 5.6kΩ "	
		INDUCTOR	R7001, 7006, 7011, 7016, 7022, 7049, 7053, 7056, 7060, 7066, 7068, 7069, 7072, 7073	J02245103	" " " 10kΩ "	
L4001	L1190123	S6-392K 3.9mH				
		CONNECTORS				
J4001	P0090197	B08B-XH-A	R7062, 7074	J00215103	" " 1/8W 10kΩ	VJ
J4002, 4006	P0090194	B05B-XH-A	R7023, 7032, 7037	J02245223	" " 1/4W 22kΩ	SJ
J4003	P0090196	B07B-XH-A	R7002, 7004, 7005, 7007, 7009, 7010, 7012, 7014, 7015, 7017, 7019-7021, 7027, 7034, 7039, 7046, 7048, 7052, 7055, 7059, 7063, 7065, 7071, 7075, 7076	J02245473	" " " 47kΩ "	
J4004	P0090193	B04B-XH-A				
J4005	P0090192	B03B-XH-A				
	Q9000192	Thermal Conductor				
	Q9000284	BUSH-F				
	R0115110B	HEATSINK				
		DISPLAY UNIT	R7028	J02245563	" " " 56kΩ "	
Symbol No.	Part No.	Name & Description	R7031, 7036, 7042-7045	J02245104	" " " 100kΩ "	
	F2786000B	Printed Circuit Board	R7024	J02245124	" " " 120kΩ "	
	C027860AA	PCB with Components	R7035, 7041	J02245105	" " " 1MΩ "	
		ICs				
Q7010	G1090084	μPC78L05				CAPACITORS
Q7013	G1090546	TMS2370	C7027	K00175470	Ceramic 50WV 47pF	SL
Q7014	G1090649	M5218L				(DD104SL470J50)
Q7015	G1090257	MC14066BCP	C7026	K00175151	" " 150pF "	(DD106SL151J50)
		TRANSISTORS	C7006, 7010, 7013, 7018, 7019, 7021, 7023, 7025	K13179008	" " " 0.01μF "	(DD106F103Z50)
Q7001-7004, 7017, 7019-7025	G3304580B	2SC458B	C7016	K13179009	" " " 0.047μF "	(DD110F473Z50)
Q7005-7008, 7011, 7012, 7016, 7018	G3107331P	2SA733AP	C7002	K50177152	Mylar " 0.0015μF (50F2U152M)	
Q7009	G3304960Y	2SC496Y				
		DIODES	C7007	K50177222	" " " 0.0022μF (50F2U222M)	
D7003, 7008, 7011, 7012	G2090340	1SS83 Si	C7005	K50177153	" " " 0.015μF (50F2U153M)	
D7004, 7006, 7007, 7022-7058	G2090237	MA190 "	C7004, 7022, 7024	K40179013	Electrolytic " 1μF (RE-50V010M)	
D7001	G2090265	RD30EB2 Zener				
D7002, 7059	G2090188	HZ5C1 "	C7017	K40179009	" " " 2.2μF (RE-50V2R2M)	
D7005	G2090266	RD3.9EB2 "				
D7013	G2090362	LT-9002D LED				

C7001	K40179014	Electrolytic 50WV 10 μ F (RE-50V100M)	R6011, 6019, 6028, 6030	J02245103	" " " 10k Ω SJ
C7012, 7015, 7020	K40129004	" 16WV 10 μ F (RE-16V100M)	R6031	J01245103	" " " 10k Ω TJ
C7009	K40129008	" " 33 μ F (RE-16V330M)	R6014	J02245153	" " " 15k Ω SJ
C7011, 7014	K40129002	" " 47 μ F (RE-16V470M)	R6007	J02245473	" " " 47k Ω "
C7003	K40129007	" " 100 μ F (RE-16V101M)	R6002	J02245683	" " " 68k Ω "
			R6017, 6027	J02245104	" " " 100k Ω "
			R6032	J01215104	" " " 1/8W 100k Ω TJ
			R6001, 6009	J20356102	Metallic " 3W 1k Ω
			R6018	J30376019	Cement 5W 0.1 Ω
			R6003-6005	J30376029	" " 0.2 Ω
		INDUCTORS	R6029 ■	J32009003	R125 J(Meter Shunt) 0.125 Ω
L7001, L7002	L1190123	S6-392K 3.9mH	R6029 ▲	J32009004	R025 J(Meter Shunt) 0.025 Ω
					POTENTIOMETERS
		DC-DC TRANSFORMER	VR6001, 6002	J50709102	H1052A007 -1KB 1k Ω B
T7001	L3030122		VR6003	J50709472	H1052A011 -4.7KB 4.7K Ω B
			VR6004	J51757472	H1052C -4.7KB 4.7K Ω B
		SWITCHES			CAPACITORS
S7001-7017, 7019-7022, 7024-7026, 7029-7031	N5090028	KHH10914	C6008	K13179008	Ceramic 50WV 0.01 μ F F (DD106F103Z50)
			C6007, 6014	K13179009	" " 0.047 μ F "
					(DD110F103Z50)
S7018, 7023, 7027, 7028	N4090081	SPH121C16	C6012	K50170015	Mylar " 0.022 μ F (50F2D223M)
S7032	N4090082	SPH122C07	C6005	K50170017	" " 0.047 μ F (50F2D473M)
					Electrolytic " 47 μ F (RE2-50V470M)
		CONNECTORS	C6004	K40179028	" 35WV 47 μ F (RE2-35V470M)
J7001, 7003, 7004	P0090191	B02B-XH-A	C6006	K40169013	" 50WV 100 μ F (RE2-50V101M)
J7002	P0090192	B03B-XH-A	C6003	K40179032	" 25WV 100 μ F (RE-25V101M)
					" " 330 μ F (RE2-25V331M)
		PS UNIT	C6009	K42140004	" " 18000 μ F (25LP183)
Symbol No.	Part No.	Name & Description	C6001, 6002	K42170004	" 50WV 18000 μ F (50L18000)
	F2787000A	Printed Circuit Board	C6013	K40149003	" " 330 μ F (RE-25V101M)
	C027870AA	PCB with Components	C6010, 6011	K40149030	" " 18000 μ F (50L18000)
					Barrier Layer 25WV 0.068 μ F (UAT10X683K-L45AE)
		FET			CONNECTORS
Q6007	G3801921G	2SK192AGR	C6009	K42140004	B02B-XH-A
					P6001
		TRANSISTORS			T9205242A
Q6001, 6006	G3304580B	2SC458B			
Q6002, 6004, 6009	G3107331P	2SA733AP			
Q6003	G3110120Y	2SA1012Y			
Q6008	G3109500Y	2SA950Y			
Q6010	G3110150G	2SA1015GR			
Q6011-6014	G3407170Y	2SD717Y	J6001, 6002, 6004	P0090191	B02B-XH-A
Q6005	G3106840R	2SA684R	P6001	T9205242A	
		DIODES			
D6001, 6002, 6005, 6007, 6008	G2090306	10E1 Si			
D6003	G2090237	MA190 "			
D6006, 6009	G2090111	HZ6C1 Zener			
D6004	G3090044	CW12B Thyristor			
					ICs
			Q9009	G1090294	μ PC7808H
		THERMISTOR	Q9010	G1090549	TL7705CPB
TH6001	G9090015	SDT-100			
					TRANSISTORS
			Q9001	G3319710	2SC1971
		RESISTORS	Q9002, 9003	G3323950	2SC2395
R6022	J02245560	Carbon film 1/4W 56 Ω SJ	Q9004, 9005	G3090059	MRF422
R6006, 6008, 6012	J02245471	" " " 470 Ω "	Q9006	G3110120Y	2SA1012Y
R6023	J02245821	" " " 820 Ω "	Q9007, 9008	G3304580B	2SC458B
R6010, 6016, 6021, 6026	J02245102	" " " 1k Ω "	Q9011	G3408800O	2SD880-O
R6013	J02245152	" " " 1.5k Ω "	Q9012	G3109520L	2SA952L
R6015, 6024, 6025	J02245332	" " " 3.3k Ω "			
R6020	J02245392	" " " 3.9k Ω "			DIODES
			D9002-9005	G2090002	10D10 Si

■ 10W Type
▲ 100W Type

D9001	G2090217	HZ3C1 Zener	C9002, 9004, 9028, 9030, 9037, 9040	K40129004	Electrolytic 16WV 10 μ F (RE-16V100M)
		THERMISTOR	C9043	K40129016	" " 22 μ F (RE-16V220M)
TH9001	G9090011	SDT-1000	C9033	K40169020	" 35WV 330 μ F (RE2-35V331M)
		RESISTORS			
R9020, 9021	J22379006	Metallic film 5W 39 Ω			
R9009, 9010	J00275159	Carbon film 1/2W 1.5 Ω VJ			INDUCTORS
R9016, 9017	J20306159	Metallic " 1W 1.5 Ω	L9001, 9003, 9009	L1020015	
R9006	J02245479	Carbon " 1/4W 4.7 Ω SJ	L9002	L1190235	LAL04NA6R8K 6.8 μ H
R9035	J01275180	" " 1/2W 18 Ω TJ	L9004, 9005, 9007, 9008	L1020035A	
R9018, 9019	J20306180	Metallic " 1W 18 Ω	L9006	L0021432	
R9011, 9012	J01275240	Carbon " 1/2W 24 Ω TJ	L9010	L1190037	LAL04NA151K 150 μ H
R9002	J02245330	" " 1/4W 33 Ω SJ			
R9008	J01275390	" " 1/2W 39 Ω TJ			
R9015	J21339003	Metallic " 2W 39 Ω			TRANSFORMERS
	J22359001	" " 3W 39 Ω	T9001	L0021402	
R9022	J21339004	" " 2W 68 Ω	T9002	L0021403A	
R9001	J02245121	Carbon " 1/4W 120 Ω SJ	T9003	L0021606	
R9013, 9014	J01275121	" " 1/2W 120 Ω TJ			
R9029	J01275151	" " " 150 Ω "			CONNECTORS
R9003, 9005	J02245331	" " 1/4W 330 Ω SJ	J9001, 9002	P1090255	TMP-JA
R9036	J01275331	" " 1/2W 330 Ω TJ	J9003	P0090194	B05B-XH-A
R9024	J02245102	" " 1/4W 1k Ω SJ	J9004, 9005, 9011	P0090191	B02B-XH-A
R9007	J01275102	" " 1/2W 1k Ω TJ	J9007, 9008, 9009, 9010	R0100970	Terminal
R9033	J20306102	Metallic " 1W 1k Ω			
R9004	J02245152	Carbon " 1/4W 1.5k Ω SJ			
R9025	J02245222	" " " 2.2k Ω "			FUSE
R9030-9032	J02245472	" " " 4.7k Ω "	F9001	Q0000012	6A
R9023, 9027, 9028, 9034	J02245103	" " " 10k Ω "			FUSE HOLDER
R9037	J01245103	" " " 10k Ω TJ	FH9001	P2000029	AFP226
		POTENTIOMETER		Q9000192	30F-T0-220 Insulator
VR9001	J51727102	H1021A307 -1KB 1k Ω B		Q9000110	YC-40B "
				R0102810	Nut
					10W PA UNIT
		CAPACITORS	Symbol No.	Part No.	Name & Description
C9024, 9025	K30279045	Dipped Mica 500WV 560pF (DM19D561J5)		F2789000	Printed Circuit Board
C9017	K30279092	" " " 750pF (DM19D751J5)		C027890AA	PCB with Components
C9018, 9019	K30279097	" " " 5000pF (DM19D502J5)	Q8008	G1090080	μ PD 78L05
C9014	K00275820	Ceramic " 82pF SL (DD109SL820J500)			TRANSISTORS
C9007	K10176332	" 50WV 0.0033 μ F B (DD107B332K50)	Q8001	G3320530	2SC2053
C9010, 9011	K10179038	" " 0.0047 μ F B (DD108B472K50)	Q8002	G3321660	2SC2166
C9006, 9015, 9031 9035	K13179008	" " 0.01 μ F F (DD106F103Z50)	Q8003, 8004	G3090071	MRF485
C9001, 9003, 9005, 9008, 9012, 9013, 9016, 9027, 9029, 9032, 9034, 9038, 9039	K13179009	" " 0.047 μ F " (DD110F473Z50)	Q8005	G3110120Y	2SA1012Y
			Q8006, 8007	G3304580B	2SC458B
			Q8009	G3408820Q	2SD882Q
					DIODES
			D8001	G2090217	HZ3C1 Zener
			D8002	G2090306	10E10 Si
			D8003	G2015880	1S1588 "
					RESISTORS
C9020, 9023	K10246103	" 250WV 0.01 μ F (CD125XB103K250)	R8005	J02245479	Carbon film 1/4W 4.7 Ω SJ
C9036	K19149025	Barrier Layer 25WV 0.1 μ F (UAT10X104K-L45AE)	R8015, 8016	J01275150	" 1/2W 15 Ω TJ
C9009, 9042	K50177103	Mylar 50WV 0.01 μ F (50F2U103M)	R8014	J01275390	" " " 39 Ω "
C9021, 9022	K55239001	" 200WV 0.047 μ F (PRA473K200)	R8004	J02245470	" 1/4W 47 Ω SJ
C9041	K40179013	Electrolytic 50WV 1 μ F (RE-50V010M)	R8027	J20336680	Metallic " 2W 68 Ω
			R8012	J02245101	Carbon " 1/4W 100 Ω SJ
			R8001, 8006	J01245121	" " " 120 Ω TJ
			R8017, 8018	J20336151	Metallic " 2W 150 Ω
			R8007, 8009, 8026	J02245221	Carbon " 1/4W 220 Ω SJ

			TRV CNTL UNIT		
Symbol No.	Part No.	Name & Description			
R8003, 8008	J02245471	Carbon film 1/4W 470Ω SJ			
R8010, 8011	J01245821	" " " 820Ω TJ			
R8020	J02245102	" " " 1kΩ SJ		F2790000	Printed Circuit Board
R8013	J01275102	" " 1/2W 1kΩ TJ		C027900AA	PCB with Components
R8028	J20306102	Metallic " 1W 1kΩ			
R8002	J01245122	Carbon film 1/4W 1.2kΩ TJ			CONNECTORS
R8022	J02245220	" " " 2.2kΩ SJ	J4201-4204	P1090210	TMP-JV
R8023	J02245472	" " " 4.7kΩ "	J4205, 4207, 4209, 4210	P0090192	B03B-XH-A
R8019, 8021, 8024, 8025	J02245103	" " " 10kΩ "	J4206	P0090194	B05B-XH-A
			J4208	P0090193	B04B-XH-A
		POTENTIOMETER	MJ4201-4203	P4090021	CR7C-28DB-4DS
VR8001	J51727222	H1021A309-2.2KB 2.2KΩ B			
		CAPACITORS			
C8003	K10176222	Ceramic 50WV 0.0022μF B (DD106B222K50)			TUNER UNIT
			Symbol No.	Part No.	Name & Description
C8001, 8018, 8029	K13179008	" " 0.01μF F (DD106F103Z50)		F2791000A	Printed Circuit Board
				C027910AA	PCB with Components
C8002, 8004-8006, 8008-8010, 8012, 8013, 8016, 8019, 8023, 8025, 8027, 8028, 8031, 8032	K13179009	" " 0.047μF " (DD110F473Z50)			ICs
			Q5003	G1090257	MC14066BCP
			Q5004	G1090552	μPD277C
			Q5005	G1090553	μPD7507C-070 (Y-16)
C8020, 8021	K50177154	Mylar " 0.15μF (50F2U154M)	Q5006	G1090088	MC14028BCP
			Q5007, 5008	G1090029	MC14071BCP
C8007	K40129004	Electrolytic 16WV 10μF (RE-16V100M)	Q5009	G1090721	M54563P
			Q5020, 5021	G1090716	TH3C10
C8024	K40149008	" 25WV " (RE-25V100M)	Q5022	G1090294	μPC7808H
			Q5023	G1090848	μPC78L05J
C8026, 8030	K40129008	" 16WV 33μF (RE-16V330M)			FET
C8017	K40169020	" 35WV 330μF (RE2-35V331M)	Q5001	G3801520C	2SK152-3
					TRANSISTORS
		INDUCTORS	Q5002, 5010-5015	G3304580B	2SC458B
L8001	L1190313	LAL04NAR47M 0.47μH	Q5016-5019	G3090074	BA1A4M
L8002	L1190131	" 1R8M 1.8μH			
L8003, 8008	L1190330	" 390K 39μH			DIODES
L8004, 8006	L1020032		D5001	G2090188	HZ5C1 Zener
L8005	L1020015		D5002	G2090223	1SS101 Schottky
L8007	L1020666A		D5003-5009, 5011, 5012, 5014, 5017	G2090027	1SS53 Si
		TRANSFORMERS	D5010, 5013, 5015	G2090306	10E1 "
T8001	L0020789A		D5016	G2090118	1SS97 Schottky
T8002	L0021607				RESISTORS
T8003	L0021608		R5013	J02245221	Carbon film 1/4W 220Ω SJ
			R5011	J02245102	" " " 1kΩ "
		CONNECTORS	R5081, 5082, 5085,	J01245102	" " " 1kΩ TJ
J8001, 8002	P1090255	TMP-JA	5086		
J8003	P0090194	B05B-XH-A	R5017	J02245182	" " " 1.8kΩ SJ
J8004, 8005, 8011	P0090191	B02B-XH-A	R5005	J02245332	" " " 3.3kΩ "
J8007-8010	R0100970	TERMINAL	R5079, 5080	J01245332	" " " 3.3kΩ TJ
			R5063, 5065, 5067,	J02245472	" " " 4.7kΩ SJ
		FUSE	5069, 5083, 5084, 5088		
F8001	Q0000012	6A	R5087	J01245472	" " " 4.7kΩ TJ
		FUSE HOLDER	R5091	J01245103	" " " 10kΩ "
FH8001	P2000029	AFP 226	R5007, 5008, 5018-5021, 5049, 5050, 5052, 5053 5064, 5066, 5068, 5070, 5077, 5078	J02245103	" " " 10kΩ SJ
	Q9000192	30F-T0-220 Insulator			
	Q9000110	YC-40B "			
			R5073	J02245123	" " " 12kΩ "
	R0103760	HEATSINK	R5004	J02245333	" " " 33kΩ "
	R0102810	Nut	R5003, 5022-5031	J02245473	" " " 47kΩ "
	R7116450B	Press Board	R5076	J01245473	" " " 47kΩ TJ

R5041-5047	J20249002	Metallic film 1/4W 49.9kΩ	C5007	K40179006	Tantalum 50WV 2.2μF (RC2-50V2R2M)
R5016	J02245563	Carbon " " 56kΩ SJ			
R5001, 5002	J02245823	" " " 82kΩ "	C5029	K41140476	" 25WV 47μF (25TL470)
R5075	J01245823	" " " " TJ			
R5006, 5071, 5072, 5074	J02245104	" " " 100kΩSJ	C5033	K40109015	" 10WV 100μF (RC2-10V101M)
R5032-5040	J20249045	Metallic " " 100kΩ	C5031	K41120227	" 16WV 220μF (16TL221)
R5012	J02245154	Carbon " " 150kΩSJ			
R5051, 5059-5061	J02245224	" " " 220kΩ "			
R5009	J02245474	" " " 470kΩ "			
R5048, 5089	J02245684	" " " 680kΩ "			BLOCK CAPACITORS
R5010, 5014, 5055-5058	J02245105	" " " 1MΩ "	C5018, 5019	K80000001	0.01μF×4 (CA1034)
R5090	J01245105	" " " 1MΩ TJ	C5017	K80000002	0.01μF×6 (CA1036)
		BLOCK RESISTORS	C5024, 5025	K80000007	0.01μF×8 (CA1038)
RB5001	J40900010	RK1/16 B4R103 1kΩ×4			
RB5002	J40900027	RA1/16 B7R224 220kΩ×7			
		POTENTIOMETERS			VALIABLE CAPACITORS
VR5001	J51723104	H1051A019-100KB 100kΩ B	VC5001, 5002	K90000044	YV-300 300pF
VR5002, 5003, 5004	J51723103	H1051A013-10KB 10kΩ "			
		CAPACITORS			INDUCTORS
C5028	K02175330	Ceramic 50WV 33pF CH (DD105CH330J50)	L5001, 5002	L0021603	5.31μH
C5016	K02175101	" " 100pF "	L5003	L0021602	2.50μH
		(DD107CH102K50)	L5004	L0021604	1.66μH
C5008, 5012, 5015, 5066	K10176102	" " 0.001μF B (DD104B102K50)	L5005	L0021601	0.721μH
C5062-5065	K13179008	" " 0.01μF F (DD106F103Z50)	L5006	L1190017	FL5H102K 1mH
C5001, 5002, 5006, 5009-5011, 5013, 5020-5023, 5027, 5030, 5032, 5034, 5035, 5055	K13179010	" " 0.022μF " (DD108F223Z50)	L5007, 5008	L1190189	LAL03NA102K "
					RELAYS
C5003, 5036-5045, 5058-5061	K13179009	" " 0.047μF " (DD110F473Z50)	RL5001-5011	M1190069	AGP2013
C5004	K30275100	Dipped Mica 500WV 10pF (LCQ11100J5)			CONNECTORS
C5054	K30309038	" " 1KWV 18pF (DML2 180J10)	J5001	P0090205	S04B-XH-A
C5053	K30309037	" " " 30pF (DML2 300J10)	J5002	P0090206	S05B-XH-A
C5052	K30309036	" " " 39pF (DML2 390J10)	J5003	P0090208	S07B-XH-A
C5051	K30309001	" " " 75pF (DML2 750J10)			SWITCH
C5005	K30275101	" " 500WV 100pF (LCQ12101J5)	SW5001	N6090064	SS-912
C5049, 5050	K30309039	" " 1KWV 110pF (DML2 111J10)			BATTERY
C5057	K30309035	" " " 120pF (DML2 121J10)	BA5001	Q9000106	CR-2025-WT2
C5056	K30309004	" " " 150pF (DML2 151J10)			MOTORS
C5046	K30309006	" " " 180pF (DML2 181J10)			
C5048	K30309011	" " " 300pF (DML2 301J10)		Q5000016	TP-E Terminal Post
C5047	K30309002	" " " 820pF (DML2 821J10)		S1000003	116-4 Coupler
C5026	K40179001	Electrolytic 50WV 1μF (RC2-50V010M)			
C5067	K40167474	" 35WV 0.47μF (RE-35V222M)		R0803320A	Shield Case
				R0803330A	Shield Cover
				R0114900	Holder
				R7116460	Press Board
				R7079690	

TONE BURST UNIT			POTENTIOMETER		
Symbol No.	Part No.	Name & Description	VR7401	J51745103	H0651A013-10KB 10KΩ B
		TONE BURST UNIT			
	F2797000	Printed Circuit Board			SWITCH
	C027970AA	PCB with Components	S7401	N4090102	SUJ A1
		IC			CONNECTOR
Q4104	G1090239	TC5082P-G		P0090191	B02B-XH-A
		TRANSISTORS			
Q4101, 4102	G3304580B	2SC458B			
Q4103	G3107331Q	2SA733AQ			
			SW B UNIT		
		DIODES	Symbol No.	Part No.	Name & Description
D4101-4104	G2090237	MA190		F2802102	Printed Circuit Board
				C028022AA	PCB with Components
		CRYSTAL			
X4101 ▲	H0101982	HC-18/T 7.168MHz			DIODES
X4101 ■	H0101983	" 7.3728MHz	D7501-7503	G2090267	SG238D LED
			D7504	G2090268	SY438D "
		RESISTORS	D7505	G2090269	SR538D "
R4109	J02245101	Carbon film 1/4W 100Ω SJ			
R4104	J02245471	" " " 470Ω "			RESISTORS
R4108	J02245222	" " " 2.2kΩ "	R7501-7505	J01215102	Carbon film 1/8W 1kΩ TJ
R4105	J02245472	" " " 4.7kΩ "			
R4110, 4111	J02245103	" " " 10kΩ "			SWITCH
R4102, 4103, 4106, 4107	J02245473	" " " 47kΩ "	S7501	N4090103	SEA51A
R4101	J02245155	" " " 1.5MΩ "			
		POTENTIOMETER	SW C UNIT		
VR4101	J51745103	H0651A013-10KB 10KΩ B	Symbol No.	Part No.	Name & Description
				F2802103	Printed Circuit Board
		CAPACITORS		C028023AA	PCB with Components
C4102	K00175150	Ceramic 50WV 15pF SL (DD104SL150J50)			DIODES
C4103, 4104	K00175330	" " " 33pF " (DD104SL330J50)	D7601	G2090188	HZ5C1 Zener
C4105	K13179008	" " " 0.01μF " (DD106F103Z50)			SWITCHES
C4107	K50170014	Mylar (50F2D103M) " 0.01μF	S7601	N4090104	SUJ12
C4108	K40179013	Electrolytic " 1μF (RE-50V010M)	S7602	N0190137	SBM1025 (SRBM25)
C4101	K40179009	" " " 2.2μF (RE-50V2R2M)			
C4106	K40129004	" 16WV 10μF (RE-16V100M)	VR A UNIT		
			Symbol No.	Part No.	Name & Description
		SWITCH		F2802104A	Printed Circuit Board
S4101	N6090033	SSS21200		C028024AA	PCB with Components
					RESISTORS
		CONNECTORS			POTENTIOMETERS
J4101	P0090191	B02B-XH-A	VR7101	J62800088	RKBBB0 10KB/10KB K12B60026 10KB/μCB
J4102	P0090195	B06B-XH-A			
			VR7102	J63800004	RKBBC1 50KB/10KB×2 K12C1101Y 50KB/10KB×2/SW
	S6000092	KGLS-12R Spacer			
			VR7103	J62800089	RKBBB0 5KB/10KA K12B60026 5KB/10KA
SW A UNIT					
Symbol No.	Part No.	Name & Description			CONNECTORS
	F2802101	Printed Circuit Board			
	C028021AA	PCB with Components	J7101	P0090191	B02B-XH-A
			J7102	P1090522	SG-4117
		DIODES			
D7401-7405	G2090237	MA190 Si			

▲ 1750Hz
■ 1800Hz

VR B UNIT			ACCESSORIES		
Symbol No.	Part No.	Name & Description	Symbol No.	Part No.	Name & Description
	F2802105A	Printed Circuit Board			AC POWER CORD
	C028025AA	PCB with Components		T9013280	2 wire, 2prong plug
				T9013282	3 wire, 3 prong plug (UL)
		RESISTORS		T9013283	3 wire, 3prong Australian plug
R7203	J02245182	Carbon film 1/4W 1.8kΩSJ		T9013285	3 wire, 2prong EU plug
R7201	J02245222	" " " 2.2kΩ "			
R7202	J02245272	" " " 2.7kΩ "			
R7204	J02245103	" " " 10kΩ "			FUSE
R7205	J02245183	" " " 18kΩ "		Q0000007	10A 100-117V AC
				Q0000005	5A 220-234V AC
		POTENTIOMETERS			
VR7201	J62800090	RKBBB0 10KA/10KB 10KΩA/10KΩ B			PLUGS
				PP0090008	S-H3603
VR7202	J62800091	2KC/5KB 2KΩC/5KΩ B		P0090544	T-1447
				P0090034	P2204/C107
VR7203	J60800125	RKBBA5 250KB/2-3 SW 250KΩB/2-3 SW			
				R3054620	Foot 30A
				R7054630A	Pad
		CAPACITOR			
C7201	K50177683	Mylar 50WV 0.068μF (50F2U683M)			
		CONNECTORS			
J7201-7203	P0090191	B02B-XH-A			
VR C UNIT					
Symbol No.	Part No.	Name & Description			
	F2802106	Printed Circuit Board			
	C028026AA	PCB with Components			
		TRANSISTOR			
Q7301	G3319590Y	2SC1959Y			
		RESISTORS			
R7307	J02245150	Carbon film 1/4W 15Ω SJ			
R7306	J02245330	" " " 33Ω "			
R7303	J02245472	" " " 4.7kΩ "			
R7308	J02245822	" " " 8.2kΩ "			
R7301, 7302	J02245103	" " " 10kΩ "			
R7304, 7309, 7310	J02245153	" " " 15kΩ "			
R7305	J02245223	" " " 22kΩ "			
		POTENTIOMETERS			
VR7301, 7302, 7303	J60800123	RK9A10 10KB 10kΩ B			
VR7304	J61800019	RK9AD0 5KB×2 5kΩB×2			
		CAPACITORS			
C7301	K40179027	Electrolytic 50WV 0.33μF (RE-50VR33M)			
C7302	K40179013	" " " 1μF (RE-50V010M)			
		SWITCHES			
S7301	N0190133	SBM 1024			
S7302	N0190134	SBM 1023			
		CONNECTORS			
J7301, 7302, 7304	P0090191	B02B-XH-A			
J7303	P0090192	B03B-XH-A			
		TERMINAL POSTS			
TP7301, 7302	Q5000050	TP-K			

FEX-767-6

MAIN CHASSIS			R1008, 1034	J24205103	" " -103J 10kΩ
Symbol No.	Part No.	Name & Description	R1020	J24205153	" " -153J 15kΩ
		RECEPTACLE	R1011	J24205223	" " -223J 22kΩ
J1	P1090352	FM-MDR-MI (Antenna)	R1009	J24205273	" " -273J 27kΩ
			R1069	J24205333	" " -333J 33kΩ
MAIN UNIT			R1010, 1012-1014, 1016, 1019, 1024, 1026, 1027	J24205104	" " -104J 100kΩ
Symbol No.	Part No.	Name & Description			
	F2798101B	Printed Circuit Board	R1067	J24205124	" " -124J 120kΩ
	C027980A	PCB with Components	R1021	J24205225	" " -225J 2.2MΩ
		ICs			
Q1001	G1090475	M57735			POTENTIOMETERS
Q1002	G1090080	μPC 78L08	VR1001-1004	J51745473	H0651A017-47KB 47kΩ B
		FETs	C1038	K22170202	Chip Ceramic 50WV 1pF CH (C2012 CH1H 010CFA)
Q1004	G4800730Y	3SK73Y	C1057	K22170204	" " " " 3pF "
Q1005	G4800740L	3SK74Y			(C2012 CH1H 030CFA)
Q1006	G3801250	2SK125	C1036, 1040, 1055, 1059, 1092-1095	K22170205	" " " " 4pF "
		TRANSISTORS	C1054	K22170215	" " " " 15pF "
Q1003	G3320530	2SC2053	C1026, 1096	K22170217	" " " " 18pF "
Q1007	G3305350B	2SC535B			(C2012 CH1H 150JFA)
Q1008	G3320260	2SC2026	C1026, 1096	K22170217	" " " " 18pF "
Q1009	G3324071	2SC2407A			(C2012 CH1H 180JFA)
Q1010, 1011	G3106840	2SA684	C1035, 1042	K22170223	" " " " 33pF "
Q1012	G3320010	2SC2001			(C2012 CH1H 330JFA)
		DIODES	C1091	K22170225	" " " " 39pF "
D1001-1006; 1020	G2090118	1SS97 Schottky	C1033, 1104	K22170227	" " " " 47pF "
D1016, 1017, 1021	G2090237	MA190 Si			(C2012 CH1H 470JFA)
D1007	G2015550	1S1555 "	C1100	K22170229	" " " " 56pF "
D1008-1015	G2090107	1T25 Varactor			(C2012 CH1H 560JFA)
D1018	G2090135	ND487C2-3R Schottky Ring	C1019	K22170233	" " " " 82pF "
D1019, 1022	G2070018	MC2838T2B			(C2012 CH1H 820JFA)
D1023	G2090003	V06B	C1009, 1010, 1034, 1037, 1039, 1044, 1046, 1047, 1051, 1056, 1058, 1105	K22170235	" " " " 100pF "
		THERMISTOR			(C2012 CH1H 101JFA)
TH1001	G9090002	D22A			
		RESISTORS	C1008	K22170241	" " " " 180pF "
R1062, 1065	J02245100	Carbon film 1/4W 10Ω SJ			(C2012 CH1H 181JFA)
R1049	J02245470	" " " 47Ω "	C1032, 1041, 1045, 1070, 1076, 1080, 1082, 1103, 1107	K22170805	" " " " 0.001μF B (C2012 B1H 102MFA)
R1001	J01215560	" " 1/8W 56Ω TJ			
R1004	J02245101	" " 1/4W 100Ω SJ			
R1048	J01275101	" " 1/2W 100Ω TJ			
	J02245681	" " 1/4W 680Ω SJ	C1004-1007, 1011, 1014, 1016, 1021, 1024, 1029, 1030, 1043, 1048, 1050, 1052, 1053, 1060, 1061, 1064, 1066-1068, 1074, 1075, 1077, 1079, 1081, 1083-1090, 1097, 1102, 1108	K22170817	" " " " 0.01μF B (C2012 B1H 103MFA)
	J01215332	" " 1/8W 3.3kΩ TJ			
R1063, 1064	J24205000	Chip RMC1/10-000J 0Ω			
R1050, 1051, 1066	J24205100	" " -100J 10Ω			
R1047	J24205220	" " -220J 22Ω			
R1005, 1015, 1025, 1032	J24205470	" " -470J 47Ω			
R1006, 1022, 1031, 1033, 1042, 1044, 1071	J24205101	" " -101J 100Ω			
R1052	J24205121	" " -121J 120Ω			
	J24205151	" " -151J 150Ω			
R1036	J24205331	" " -331J 330Ω		K02175470	Ceramic disc 50WV 47pF CH (DD106CH470J50)
R1007, 1017, 1028, 1030, 1039, 1043	J24205471	" " -471J 470Ω		K02175101	" " " " 100pF " (DD107CH101J50)
R1002	J24205561	" " -561J 560Ω	C1013, 1015, 1017, 1018, 1020, 1023, 1027, 1078	K40129004	Electrolytic 16WV 10μF (RE-16V 100M)
R1018, 1023, 1057, 1061	J24205102	" " -102J 1kΩ			
R1003	J24205122	" " -122J 1.2kΩ	C1012	K40129049	" " " " 470μF (RE2-16V 471M)
R1055	J24205222	" " -222J 2.2kΩ			
R1035, 1041, 1046, 1053, 1068	J24205332	" " -332J 3.3kΩ			TRIMMER CAPACITORS
		" " -472J 4.7kΩ	TC1001	K91000085	CTZ51C 10pF
R1040, 1045	J24205472	" " -682J 6.8kΩ	TC1002	K91000117	CTZ51H 70pF
R1054, 1056, 1058	J24205682	" " -682J 6.8kΩ	TC1003	K91000089	CTZ51G 50pF

		INDUCTORS			POTENTIOMETER
L1005-1007, 1022	L0020824		VR2001	J51745103	H0651A013-10KB 10kΩB
L1002	L0021631				
L1003, 1004, 1018, 1019	L1190138	LAL04NA100K 10μH			
L1008	L1020663		C2013	K22170201	CAPACITORS Chip Ceramic 50WV 0.5pF CH (C2012 CH1H 0R5CFA)
L1009, 1010, 1012	L1020673				
L1011	L0020724		C2026	K22170202	" " " 1pF "
L1013	L1020683				(C2012 CH1H 010CFA)
L1014	L0020340		C2010	K22170205	" " " 4pF "
L1015	L1020680	LAL04NA 220K 22μH			(C2012 CH1H 040CFA)
L1016, 1017, 1020, 1021	L1190327		C2008, 2011, 2015, 2019	K22170207	" " " 6pF "
		TRANSFORMERS	C2003	K22170211	" " " 10pF "
	L0020825				(C2012 CH1H 100DFA)
T1001-1008, 1010	L0021462		C2006, 2012, 2014, 2018	K22170213	" " " 12pF "
T1011, 1012	L0020857				(C2012 CH1H 120JFA)
T1013			C2025, 2028	K22170219	" " " 22pF "
		RELAY			(C2012 CH1H 220JFA)
	M1190052	MR-62-12S	C2016	K22170235	" " " 100pF "
RL1001					(C2012 CH1H 101JFA)
		MINI CONNECTORS	C2007, 2022	K22170805	" " " 0.001μF B
	P0090520	3022-03B			(C2012 B1H 102MFA)
J1001	P0090594	3022-05B	C2001, 2004, 2005, 2009, 2017, 2020, 2021, 2023, 2027, 2029, 2030	K22170817	" " " 0.01μF "
J1002					(C2012 B1H 103MFA)
		TERMINAL POSTS			
	Q5000050	TP-K			
LOCAL UNIT			C2032	K02173070	Ceramic disc 50WV 7pF CH (DD104CH 070D50)
	Part No.	Name & Description			
Symbol No.	F2799101A	Printed Circuit Board	C2002	K10176102	" " " 0.001μF B
	C027990A	PCB with Components			(DD104B102K50)
			C2031	K40129004	Electrolytic 16WV 10μF (RE-16V 100M)
		IC			
Q2006	G1090649	M5218L			
		FETs	L2001, 2003	L1190329	LAL04NA 330K 33μH
Q2001, 2002	G3802410Y	2SK241Y	L2002	L1190138	LAL04NA 100K 10μH
			L2004	L1190131	LAL04NA 1R8M 1.8μH
		TRANSISTORS			
Q2003	G3326207B	2SC2620QB			TRANSFORMERS
Q2004	G33192300	2SC1923O	T2001	L0020825	
Q2005	G3316237E	2SC1623-T2BL5	T2002-2005	L0021632	
			T2006, 2007	L0021633	
		DIODES			
D2001, 2006	G2090237	MA190 Si			MINI CONNECTORS
D2002-2005	G2090107	1T25 Varactor	J2001	P1090425	5124-03BH
		RESISTORS	J2002	P1090427	5124-05BH
R2009	J01245470	Carbon film 1/4W 47Ω TJ			
R2008	J24205000	Chip RMC 1/10T-000J 0Ω			TERMINAL POSTS
R2015, 2022	J24205220	" " -220J 22Ω		Q5000050	TP-K
R2018, 2025, 2026	J24205470	" " -470J 47Ω			
R2033	J24205680	" " -680J 68Ω			
R2023, 2035	J24205151	" " -151J 150Ω			
R2016, 2024	J24205331	" " -331J 330Ω			
R2001, 2004, 2005, 2027, 2029	J24205471	" " -471J 470Ω			
R2012, 2019, 2032	J24205102	" " -102J 1kΩ			
R2028	J24205152	" " -152J 1.5kΩ			
R2014, 2020	J24205332	" " -332J 3.3kΩ			
R2013	J24205682	" " -682J 6.8kΩ			
R2021, 2030, 2031	J24205103	" " -103J 10kΩ			
	J24205153	" " -153J 15kΩ			
	J24205223	" " -223J 22kΩ			
R2002, 2003	J24205473	" " -473J 47kΩ			
R2006, 2007, 2010, 2011, 2017	J24205104	" " -104J 100kΩ			

FEX-767-2

MAIN CHASSIS			R1003	J24205122	" " -122J 1.2kΩ
Symbol No.	Part No.	Name & Description	R1055	J24205222	" " -222J 2.2kΩ
		RECEPTACLE	R1035, 1041, 1046, 1053, 1068	J24205332	" " -332J 3.3kΩ
J1	P1090352	FM-MDR-MI (Antenna)	R1040, 1045	J24205472	" " -472J 4.7kΩ
			R1054, 1056, 1058	J24205682	" " -682J 6.8kΩ
MAIN UNIT			R1008, 1009, 1034	J24205103	" " -103J 10kΩ
Symbol No.	Part No.	Name & Description	R1020	J24205153	" " -153J 15kΩ
	F2798101B	Printed Circuit Board	R1011	J24205223	" " -223J 22kΩ
	C027981A	PCB with Components	R1069	J24205473	" " -473J 47kΩ
		ICs	R1010, 1012-1014, 1016, 1019, 1024, 1026, 1027	J24205104	" " -104J 100kΩ
Q1001	G1090295	M57713	R1067	J24205124	" " -124J 120kΩ
Q1002	G1090080	μPC78L08	R1021	J24205225	" " -225J 2.2MΩ
		FETs			POTENTIOMETERS
Q1004	G4800820	3SK82	VR1001-1004	J51745473	H0651A017-47KB 47kΩ B
Q1005	G4800740L	3SK74Y			CAPACITORS
Q1006	G3801250	2SK125	C1028	K22170202	Chip Ceramic 50WV 1pF CH (C2012 CH1H 010CFA)
		TRANSISTORS	C1038	K22170203	" " " 2pF " (C2012 CH1H 020CFA)
Q1003	G3325380	2SC2538	C1036, 1040, 1055, 1059	K22170205	" " " 4pF " (C2012 CH1H 040CFA)
Q1007	G3305350B	2SC535B	C1019	K22170206	" " " 5pF " (C2012 CH1H 050CFA)
Q1008	G3320260	2SC2026	C1046, 1051, 1056, 1058	K22170208	" " " 7pF " (C2012 CH1H 070DFA)
Q1009	G3324071	2SC2407A	C1034, 1037	K22170309	" " " 8pF UJ (C2012 UJ1H 080DFA)
Q1010, 1011	G3106840	2SA684	C1039, 1109	K22170209	" " " 8pF CH (C2012 CH1H 080DFA)
Q1012	G3320010	2SC2001	C1044	K22170211	" " " 10pF " (C2012 CH1H 100DFA)
		DIODES	C1035, 1042, 1054, 1104	K22170215	" " " 15pF " (C2012 CH1H 150JFA)
D1001-1004	G2090118	1SS97 Schottky	C1009, 1010, 1045, 1105	K22170223	" " " 33pF " (C2012 CH1H 330JFA)
D1005, 1006, 1016, 1017, 1020, 1021	G2090237	MA190 Si	C1101	K22170225	" " " 39pF " (C2012 CH1H 390JFA)
D1007	G2015550	1S1555 "	C1008, 1033	K22170227	" " " 47pF " (C2012 CH1H 470JFA)
D1008-1015	G2090107	1T25 Varactor	C1106	K22170231	" " " 68pF " (C2012 CH1H 680JFA)
D1018	G2090135	ND487C2-3R Schottky Ring	C1047	K22170235	" " " 100pF " (C2012 CH1H 101JFA)
D1019, 1022	G2070018	MC2838T2B Si	C1005, 1006, 1011, 1014, 1016, 1021, 1024, 1025, 1030-1032, 1041, 1043, 1049, 1050, 1052, 1060-1062, 1070, 1076, 1077, 1079-1082, 1103	K22170805	" " " 0.001μF B (C2012 B1H 102MFA)
D1023	G2090003	V06B "			
D1024	G2090340	1SS83 "			
		THERMISTOR			
TH1001	G9090002	D22A			
		RESISTORS			
R1062, 1065	J02245100	Carbon film 1/4W 10Ω SJ			
R1004, 1049	J02245470	" " " 47Ω "			
R1048	J01275101	" " " 1/2W 100Ω TJ			
R1001	J01215221	" " " 1/8W 220Ω "			
	J02245681	" " " 1/4W 680Ω SJ			
	J01215102	" " " 1/8W 1kΩ TJ			
	J01215332	" " " 3.3kΩ "			
	J01215473	" " " 47kΩ "			
R1030, 1059	J24205000	Chip RMC1/10-000J 0Ω			
R1050, 1051, 1066	J24205100	" " " -100J 10Ω			
R1047	J24205220	" " " -220J 22Ω			
R1015, 1025, 1032	J24205470	" " " -470J 47Ω			
R1006, 1022, 1031, 1033, 1042, 1044, 1071	J24205101	" " " -101J 100Ω			
R1052	J24205121	" " " -121J 120Ω			
R1005, 1060, 1070	J24205221	" " " -221J 220Ω			
R1036	J24205331	" " " -331J 330Ω			
R1002, 1007, 1017, 1028, 1029, 1039, 1043	J24205471	" " " -471J 470Ω			
R1018, 1023, 1057, 1061, 1072	J24205102	" " " -102J 1kΩ			

C1013, 1015, 1017, 1018, 1020, 1023, 1027, 1078	K40129004	Electrolytic 16WV 10 μ F (RE-16V 100M)			THERMISTOR
			TH2001	G9090008	31D26
C1012	K40129049	" " 470 μ F (RE2-16V 471M)			RESISTORS
			R2002, 2018, 2032	J24205220	Chip RMC 1/10 -220J 22 Ω
			R2014, 2015, 2024, 2030, 2035	J24205470	" " -470J 47 Ω
		TRIMMER CAPACITORS			
TC1001, 1003	K91000108	CTZ51A 6pF	R2007, 2012, 2027	J24205101	" " -101J 100 Ω
TC1002	K91000089	CTZ51G 50pF	R2019, 2042, 2048	J24205151	" " -151J 150 Ω
			R2011, 2020, 2031, 2043	J24205331	" " -331J 330 Ω
		INDUCTORS			
L1005, 1006, 1011, 1022	L0020679		R2036, 2037, 2040, 2045	J24205471	" " -471J 470 Ω
L1002	L0021631		R2003-2005, 2008, 2022, 2026	J24205102	" " -102J 1k Ω
L1003, 1004, 1016-1018, 1020, 1023	L1190138	LAL04NA 100K 10 μ H	R2001, 2025	J24205152	" " -152J 1.5k Ω
			R2049	J2420222	" " -222J 2.2k Ω
			R2016, 2034	J24205332	" " -332J 3.3k Ω
L1007	L0020678		R2028, 2041	J24205472	" " -472J 4.7k Ω
L1008	L1020663		R2009, 2029	J24205682	" " -682J 6.8k Ω
L1009, 1010, 1012	L1020673		R2017, 2033	J24205103	" " -103J 10k Ω
L1013	L1020692A		R2044	J24205333	" " -333J 33k Ω
L1014	L0021356		R2038, 2039	J24205473	" " -473J 47k Ω
L1015	L1020688		R2006, 2013, 2021	J24205104	" " -104J 100k Ω
L1019	L1190319	LAL04NA 2R2M 2.2 μ H	R2010	J24205474	" " -474J 470k Ω
L1021	L1190327		R2047	J01215221	Carbon Film 1/8W 220 Ω TJ
			R2050	J01215222	" " " 2.2k Ω "
		TRANSFORMERS			
T1001-1008	L0020907				CAPACITORS
T1009, 1011, 1012	L0021462		C2025	K22170201	Chip Ceramic 50WV 0.5pFCH (C2012 CH1H 0R5CFA)
T1013	L0020857		C2034	K22170204	" " " 3pF "
		RELAY			(C2012 CH1H 030CFA)
RL1001	M1190052	MR-62-12S	C2020	K22170206	" " " 5pF "
					(C2012 CH1H 050CFA)
		MINI CONNECTORS	C2013	K22170208	" " " 7pF "
J1001	P0090520	3022-03B			(C2012 CH1H 070DFA)
J1002	P0090594	3022-05B	C2038	K22170209	" " " 8pF "
					(C2012 CH1H 080DFA)
		TERMINAL POSTS	C2015	K22170210	" " " 9pF "
	Q5000050	TP-K			(C2012 CH1H 090DFA)
			C2029, 2030	K22170211	" " " 10pF "
					(C2012 CH1H 100DFA)
			C2014, 2016	K22170213	" " " 12pF "
					(C2012 CH1H 120JFA)
			C2033, 2035	K22170215	" " " 15pF "
					(C2012 CH1H 150JFA)
			C2036	K22170219	" " " 22pF "
					(C2012 CH1H 220JFA)
			C2042	K22170229	" " " 56pF "
					(C2012 CH1H 560CFA)
Q2004	G1090087	MC4044P			
Q2005	G1090084	μ PC 78L05			
Q2006	G1090195	SN74LS73N	C2012, 2019, 2021-2024, 2026-2028, 2031, 2032, 2037, 2039, 2040, 2042, 2048	K22170805	" " " 0.001 μ F B (C2012 B1H 102MFA)
Q2007	G1090697	M54455L			
		TRANSISTORS			
Q2001-2003	G3327127G	2SC2712 GRTE85R			
Q2010	G3320260	2SC2026	C2003, 2006, 2008-2011, 2043-2047	K22170817	" " " 0.01 μ F B (C2012 B1H 103MFA)
Q2012, 2013, 2016	G3326207B	2SC2620 QB			
		FETs			
Q2008, 2009, 2011	G3803027Y	2SK302Y	C2049	K02173070	Ceramic disc 50WV 7pF CH (DD104CH 070D50)
Q2014, 2015	G3802410Y	2SK241Y	C2004	K52170002	Metallized Film 100WV 1 μ F (ECQ-V1H105JZ)
		DIODES			
D2001	G2090118	1SS97 Schottky	C2001	K50170019	Mylar " 0.1 μ F (50F2D 104M)
D2002, 2003	G2090107	1T25 Varactor	C2007, 2018	K40129004	Electrolytic 16WV 10 μ F (RE-16V 100M)
D2004, 2005	G2090237	MA190 Si			

FEX-767-7

MAIN CHASSIS					POTENTIOMETERS
Symbol No.	Part No.	Name & Description	VR1001	J51745331	H0651A004-330B 330ΩB
		RECEPTACLE	VR1002-1005	J51745473	H0651A017-47KB 47kΩB
J1 (A, B)	P1090547	N-RDS 020-0291 (N)			
J1 (F)	P1090352	NR-S FM-MDR-MI (M)			CAPACITORS
		MAIN UNIT	C1055	K02172159	Ceramic disc 50WV 1.5pF CH (D104CK1R5C50)
	F2851101B	Printed Circuit Board	C1035, 1048, 1061	K02172030	" " " 3pF "
	C028511A	PCB with components			(DD104CK030C50)
		ICs	C1002	K02172040	" " " 4pF "
Q1001	G1090341	M57716	C1007-1009	K02172050	" " " 5pF "
Q1010	G1090002	SN7403N			(DD104CH050C50)
Q1013	G1090084	μPC78L05	C1028	K02173060	" " " 6pF "
		FETs	C1047	K02173090	" " " 9pF "
Q1005, 1007	G3801250	2SK125			(DD104CH090D50)
Q1006	G4801210G	3SK121GR	C1026	K02175150	" " " 15pF "
Q1008	G3802410G	2SK241GR			(DD104CH150J50)
		TRANSISTORS	C1021	K02175180	" " " 18pF "
Q1002	G3314260	2SC1426	C1049	K02179009	" " " 22pF "
Q1003	G3324071	2SC2407(A)			(DD104CH220J50)
Q1004	G3333550	2SC3355	C1031	K02175330	" " " 33pF "
Q1009, 1011, 1012	G3106840	2SA684			(DD105CH330J50)
Q1014	G3090076	BA1L4L	C1077, 1078	K02175680	" " " 68pF "
		DIODES	C1003-1006, 1010, 1012, 1014, 1016, 1018, 1019, 1023, 1024, 1029, 1030, 1033, 1034, 1036-1041, 1044-1046, 1050, 1052-1054, 1057-1060, 1064-1068, 1070, 1075	K10176102	" " " 0.001μF B (DD104B102K50)
D1001, 1002, 1005, 1006	G2090118	1SS97 Schottky			
D1003, 1004, 1007-1009, 1012-1015	G2015550	1S1555 Si			
	G2090044	MC301 "			
D1016	G2090247	ND487C1-3R Schottky Ring			
		RESISTORS			
R1001, 1015, 1031	J02225470	Carbon film 1/6W 47Ω UJ			
R1009	J01225470	" " " 47Ω PJ			
R1006	J02245470	" " " 1/4W 47Ω SJ	C1071, 1074	K13179008	" " " 0.01μF F (DD106F103Z50)
R1002	J02245101	" " " 100Ω "			
R1003, 1017, 1026, 1027	J02225101	" " " 1/6W 100Ω UJ	C1025, 1051	K22170805	Chip Ceramic 50WV0.001μFB (C2012B1H102MFA)
R1011	J01225101	" " " 100Ω PJ	C1011, 1013, 1015, 1017, 1020, 1022, 1072, 1073, 1079	K40129004	Electrolytic 16WV 10μF (RE-16V100M)
R1014, 1045-1047	J02225151	" " " 150Ω UJ			
R1023	J01225151	" " " 150Ω PJ			
R1018, 1032	J02225221	" " " 220Ω "			
R1008	J01245270	" " " 1/4W 270Ω TJ			TRIMMER CAPACITORS
R1037	J02225331	" " " 1/6W 330Ω UJ	TC1001-1003	K91000108	VCT51A 6pF
R1041	J01225331	" " " 330Ω PJ			
R1038	J02225471	" " " 470Ω UJ			INDUCTORS
R1004, 1005, 1010, 1042	J01225471	" " " 470Ω PJ	L1004, 1005, 1015, 1026	L0021273	
R1016, 1030, 1040, 1044	J02225102	" " " 1kΩ UJ	L1002, 1003, 1014, 1025, 1027, 1030	L1190199	LAL03NA 2R2M
R1034	J01225102	" " " 1kΩ PJ	L1007-1009, 1018	L1020673	
R1013, 1021	J02225152	" " " 1.5kΩ UJ	L1006	L1020663	
R1012	J02225332	" " " 3.3kΩ "	L1010	L0020900	
R1036	J02225472	" " " 4.7kΩ "	L1011	L0020474	
R1022, 1035, 1039, 1043	J01225682	" " " 6.8kΩ PJ	L1012, 1017	L0021359	
	J02225103	" " " 10kΩ UJ	L1001	L0021590	
R1050, 1052, 1053	J01225473	" " " 47kΩ PJ	L1019, 1020	L0190007	
R1019	J02225104	" " " 100kΩ UJ	L1021	L1190264	L-C3A 330MA 33μH
R1049	J01225154	" " " 150kΩ PJ	L1022	L0020342	
R1051	J01225224	" " " 220kΩ "	L1023	L0020472	
R1020	J01225225	" " " 2.2MΩ "	L1024	L0020678	
R1007	J24205331	Chip RMC-1/10-331J 330Ω	L1031	L1190190	0.27μH
				L1190258	L-C3A 100KA

L1032, 1033	L1190295	LAL02NA100K	C2002(A)	K02172030	" " " 3pF "
		TRANSFORMER	C2001	K02172040	(DD104CJ030C50) " " " 4pF "
T1001	L0021546		C2002(B,F), 2014	K02172050	(DD104CH040C50) " " " 5pF "
		CAVITIES	C2029	K02173060	(DD104CH050C50) " " " 6pF "
CV1001-1004	L4020026	CV-441B	C2004	K02173070	(DD104CH060D50) " " " 7pF "
		RELAY	C2003	K02173090	(DD104CH070D50) " " " 9pF "
RL1001	M1190063	G5Y-154P-DC6V	C2015, 2016, 2055(B,F), 2056(B,F)	K02173100	(DD104CH090D50) " " " 10pF "
		CONNECTOR	C2005	K02175120	(DD104CH100D50) " " " 12pF "
P1002	P0090520	3022-03B	C2011	K02179009	(DD104CH120J50) " " " 22pF "
	P0090594	3022-05B	C2007, 2009, 2010, 2012, 2013, 2017-2021, 2024, 2025, 2026, 2031, 2035	K10176102	(DD104CH220J50) " " " 0.001μF B
		TERMINAL POSTS	C2022, 2023, 2027, 2028, 2030, 2032-2034 2036-2038, 2041, 2043-2048, 2050, 2051	K13179008	(DD104B102K50) " " " 0.01μF F
		COIL CASE	C2042	K50170019	(DD106F103Z50) " " " 0.01μF F
	L9190016	7×7	C2040	K40179013	Mylar 50WV 0.1μF (50F2D 104M)
	L9190019	10×10	C2039	K40129004	Electrolytic " 1μF (RE-50V 010M)
PLL LOCAL UNIT			C2049	K40129042	" " " 10μF (RE-16V 100M)
	F2852101A	Printed Circuit Board	C2006	K40109024	" " " 100μF (RE2-16V 101M)
	C028521A	PCB with components	C2053, 2054	K70127225	" " " 10WV 100μF (RE2-10V101M)
		ICs	TC2001	K91000148	Tantalum 16WV 2.2μF (DN1C2R2MIS)
Q2004-2006	G1090653	μPC 1651G			TRIMMER CAPACITOR
Q2008	G1090498	μPB 571C			VCT31A 157A 6pF
Q2010	G1090473	TC5081AP			CAVITIES
Q2011, 2012	G1090247	TC9122P			CV500A
		FETs			CV480A
Q2001	G3801921G	2SK192AGR			CV420A
Q2002	G3802410Y	2SK241Y			INDUCTORS
		TRANSISTORS			L2001, 2002, 2004
Q2003	G3320260	2SC2026			L1190199
Q2007	G3333540T	2SC3354T			L0021688
Q2009, 2013	G3309450P	2SC945P			L2005
Q2014	G3111150E	2SA1115E			L2006
		DIODES			L2007, 2008, 2013
D2001, 2002	G2090248	1T32 Varactor			L1190148
D2003	G2090247	ND487C1-3R Schottky Ring			L1190212
D2004-2007	G2015550	1S1555 Si			L1190212
		RESISTORS			L1190212
R2011-2013	J02225220	Carbon film 1/6W 22Ω UJ			L1190212
R2002	J02225390	" " " 39Ω "			L1190212
R2005, 2006, 2010	J02225470	" " " 47Ω "			L1190212
R2019	J02225560	" " " 56Ω "			L1190212
R2003, 2018, 2031, 2037	J02225101	" " " 100Ω "			L1190212
R2034	J01225101	" " " 100Ω PJ			L1190212
R2023, 2028	J02225151	" " " 150Ω UJ			L1190212
R2009, 2016	J02225221	" " " 220Ω "			L1190212
R2017, 2032	J01225221	" " " 220Ω PJ			L1190212
R2022, 2027	J02225331	" " " 330Ω UJ			L1190212
R2026	J02225122	" " " 1.2kΩ "			L1190212
R2025	J01225152	" " " 1.5kΩ PJ			L1190212
R2008, 2024	J02225222	" " " 2.2kΩ UJ			L1190212
R2014	J02225332	" " " 3.3kΩ "			L1190212
R2036	J01225103	" " " 10kΩ PJ			L1190212
R2007	J02225103	" " " 10kΩ UJ			L1190212
R2015, 2021, 2030	J02225183	" " " 18kΩ "			L1190212
R2033, 2035	J01225223	" " " 22kΩ PJ			L1190212
R2020, 2029	J02225333	" " " 33kΩ UJ			L1190212
R2001, 2004	J02225104	" " " 100kΩ UJ			L1190212
		CAPACITORS			L1190212
C2008	K02172020	Ceramic disc 50WV 2pFCH (DD104CK020C50)			L1190212

**LATE PRODUCTION LOT ADDENDUM
FOR**

FT-767GX

TECHNICAL SUPPLEMENT

LOCAL UNIT (PROD. LOT 18+)

FEX-767-2 PLL UNIT (PROD. LOT 18+)

YAESU MUSEN CO., LTD.

C.P.O. BOX 1500

TOKYO, JAPAN

LOCAL UNIT PA

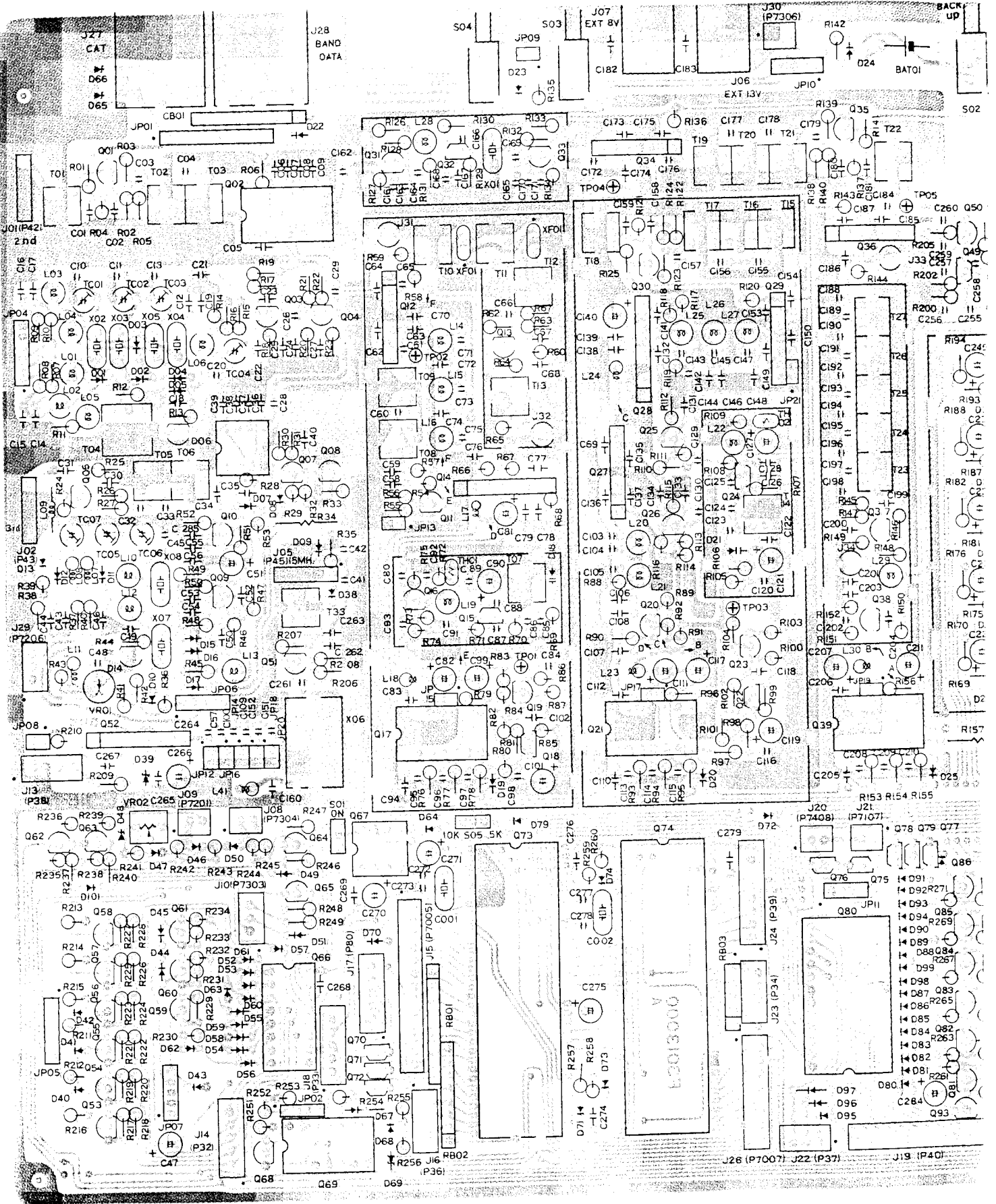

LOCAL UNIT PARTS LAYOUT

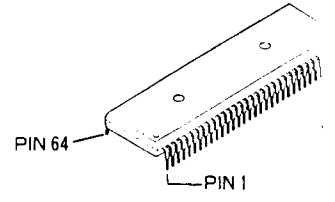
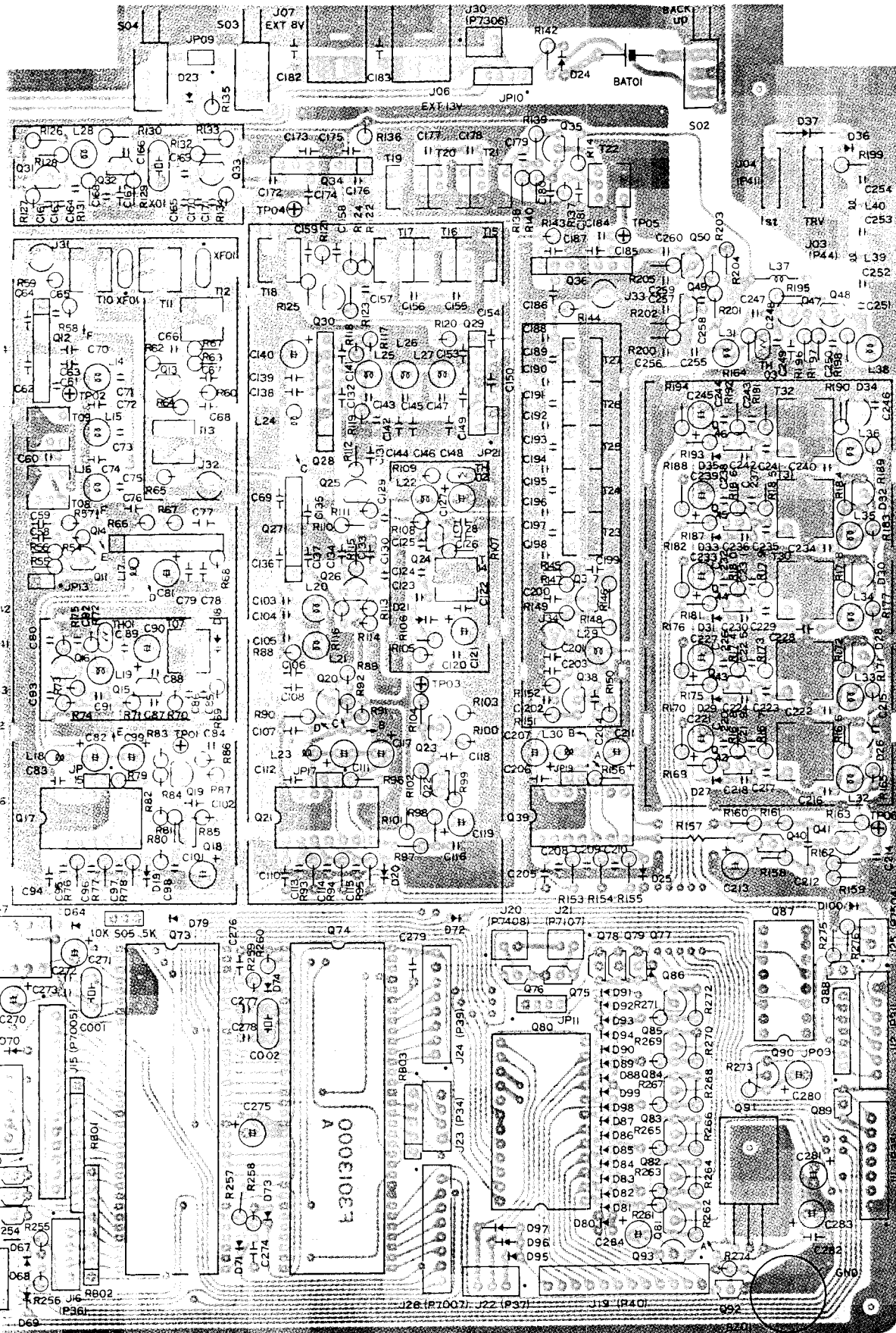

HD63A05Y0D01P (Q30)

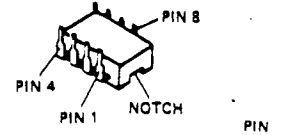

SN16913P (Q3006)
TL7705CP-B (Q3069)

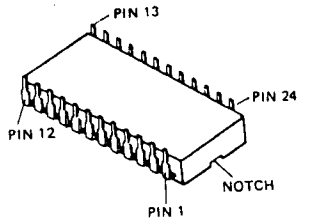

SN74159N (Q3080)

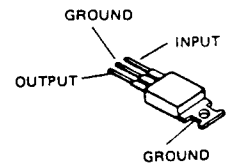

μPC7805H (Q3091)

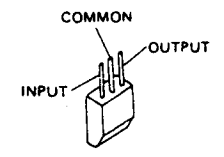

NJM78L09A (Q3093)

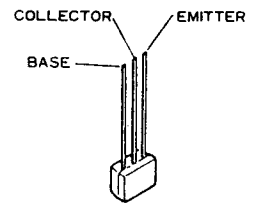

BA1A4P (Q3070~3072,
3075~3079,
3089, 3092)
BN1A4P (Q3088)

(Obverse View)

UNIT PARTS LAYOUT

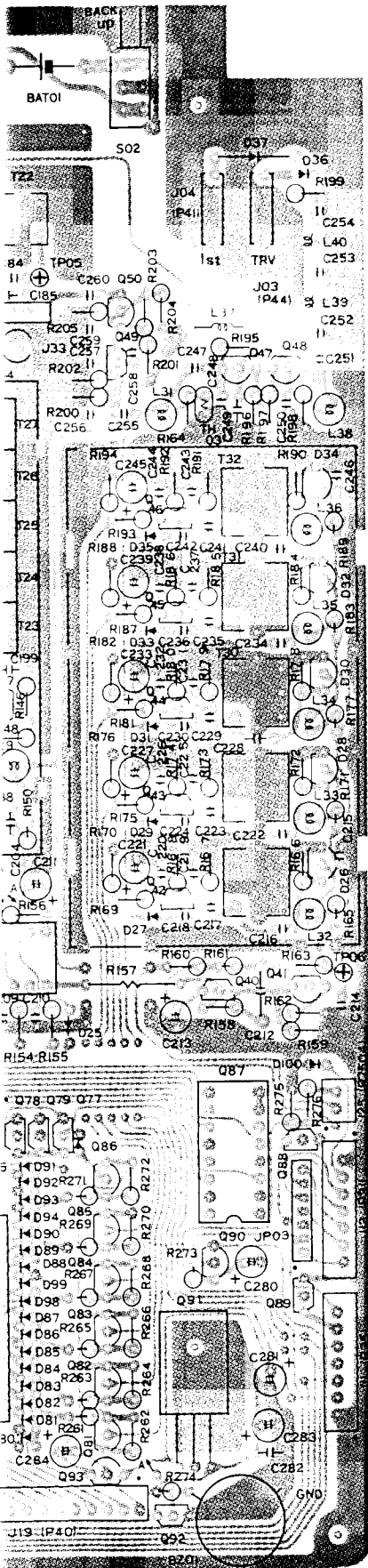

(Obverse View)

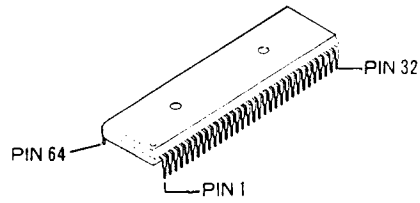

HD63A05Y0D01P (Q3073)

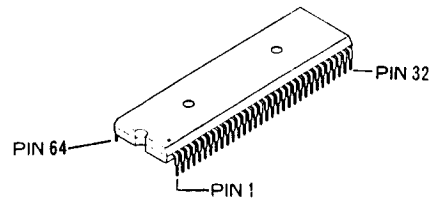

μPD65006-Y01 (Q3074)

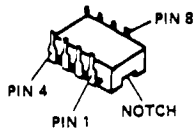

SN16913P (Q3006)
TL7705CP-B (Q3069)

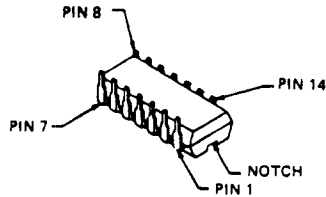

CX7925B (Q3017, 3021,
3039)
MC14011BCP (Q3069)
SN76514N (Q3002)

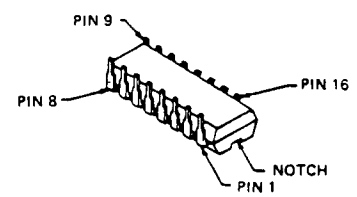

MC14050BCP (Q3087)
SN74LS145N (Q3066)

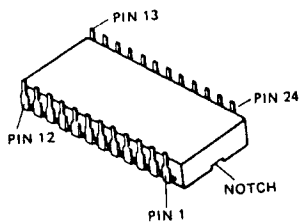

SN74159N (Q3080)

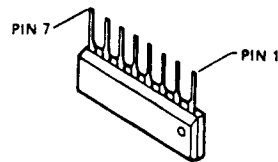

μPC1037H (Q3012, 3027,
3029, 3034,
3036)

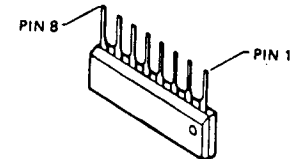

HD10551 (Q3052)
M54459L
(Q3014, 3028)

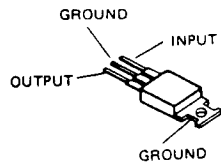

μPC7805H (Q3091)

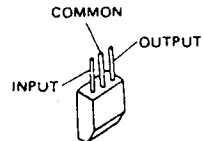

NJM78L09A (Q3093)

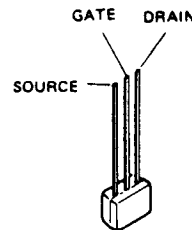

2SK184Y (Q3018, 3022,
3040)

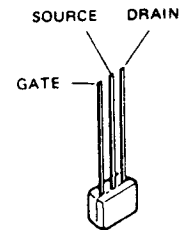

2SK192ABL (Q3042~3046)
2SK192AGR (Q3015, 3024,
3032, 3049)

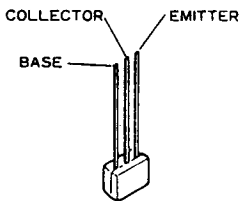

BA1A4P (Q3070~3072,
3075~3079,
3089, 3092)
BN1A4P (Q3088)

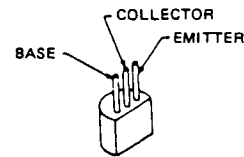

2SA733AP (Q3053~3065,
3081~3086)
2SC535C (Q3001, 3003, 3011,
3013, 3016, 3035,
3037, 3038, 3047,
3048, 3050)
2SC732TMBL (Q3019, 3023, 3041)
2SC945AQ (Q3004, 3005, 3007~
3010, 3020, 3025,
3026, 3030, 3031,
3033, 3051, 3068)
2SD667C (Q3090)

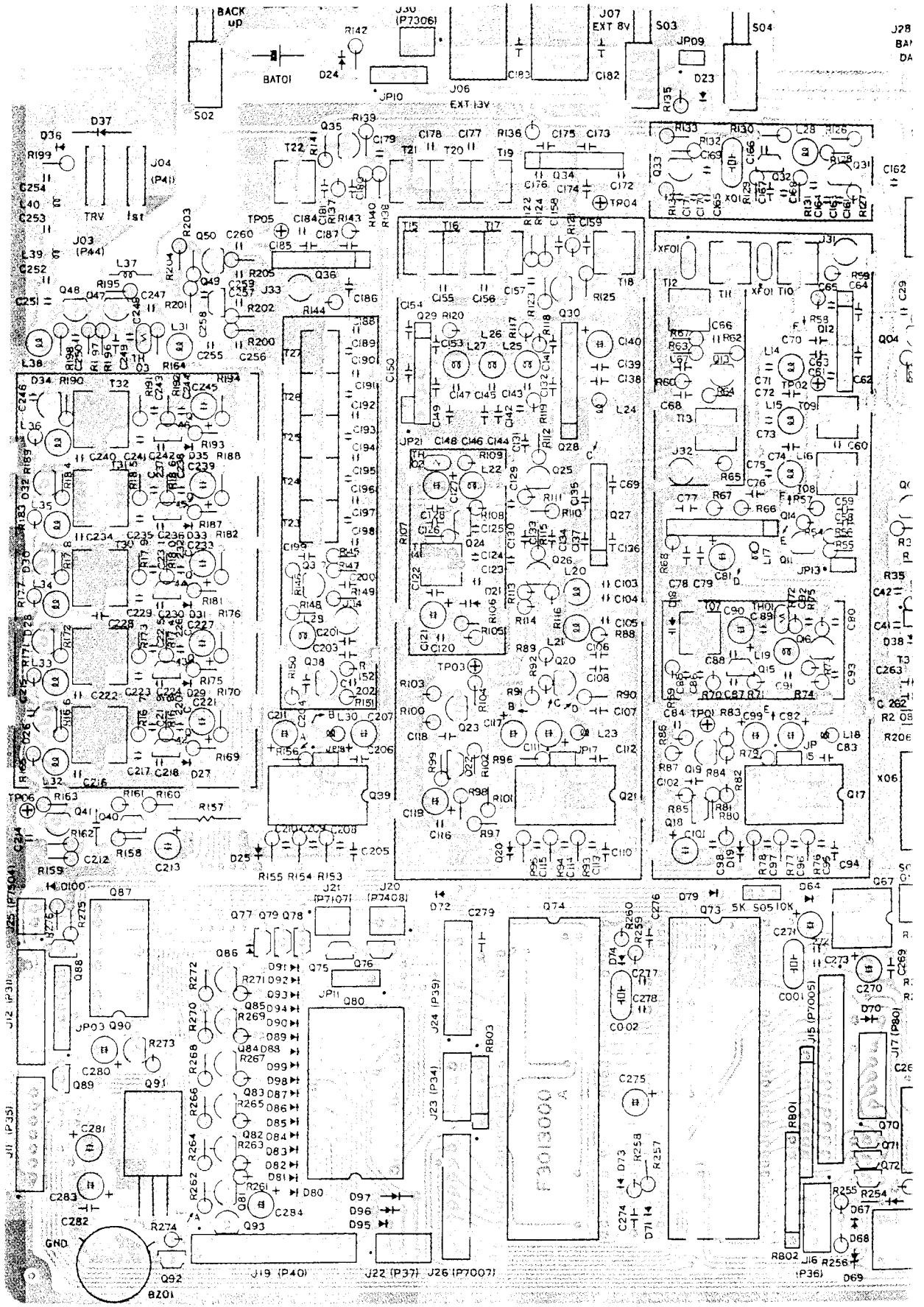

LOCAL UNIT PARTS LAYOUT

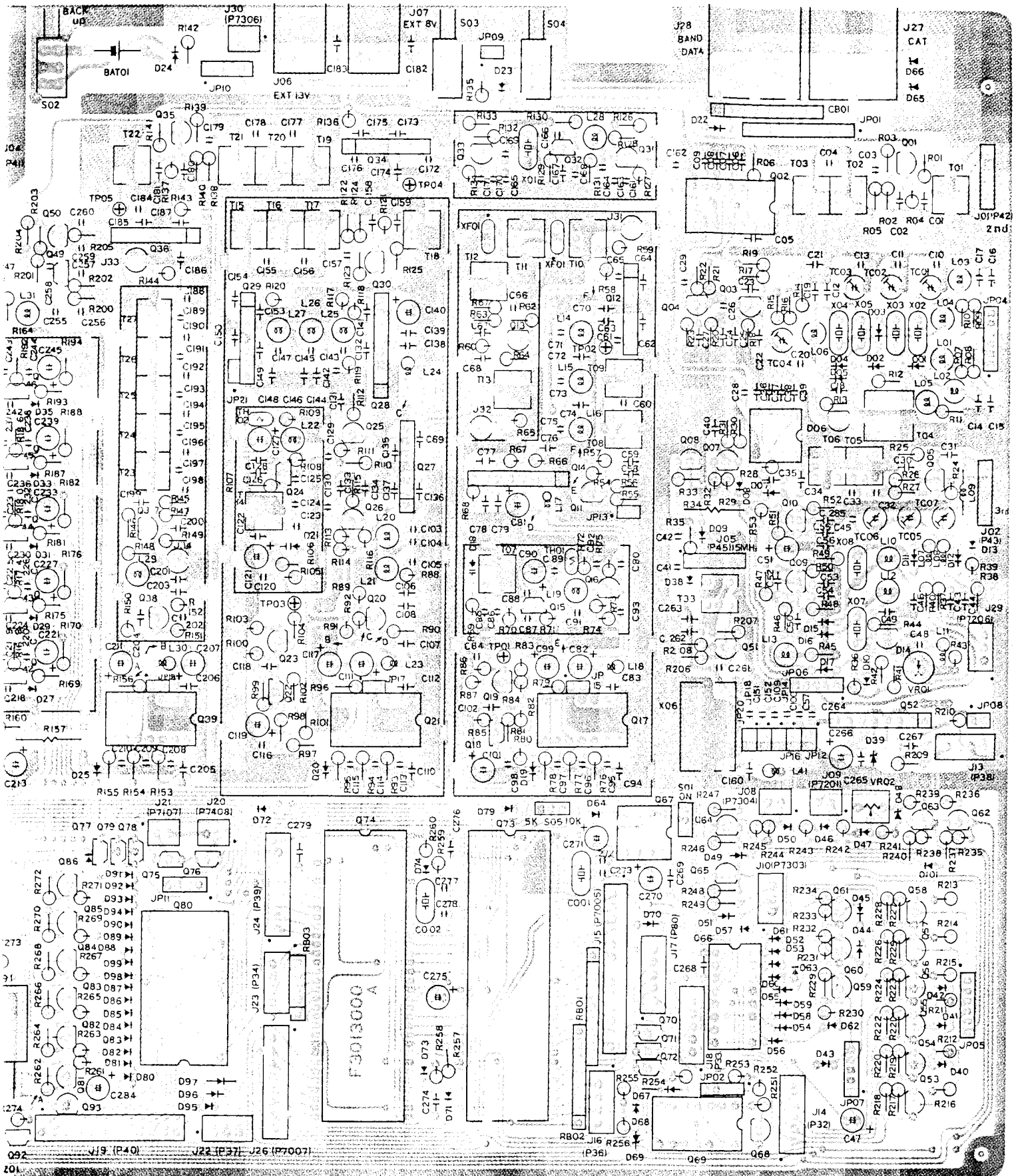

(Reverse View)

L UNIT PARTS LAYOUT

LOCAL UNIT VOLTAGE CHART (DC VOLT)

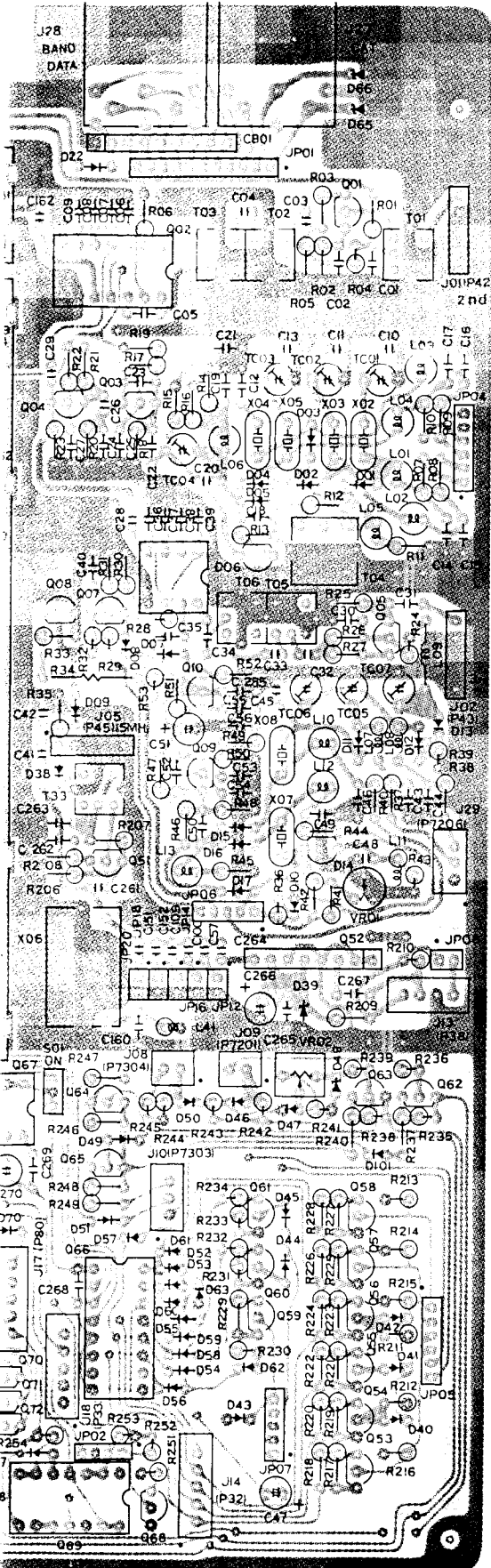

(Reverse View)

	E (S)	C (D)	B (G)	REMARKS
Q3001	2.15	7.65	1.40	
Q3003	1.07/1.07	7.68/7.68	1.87/1.79	RX/TX
Q3004	3.36	7.26	4.00	
Q3005	1.20/1.20	6.75/6.75	1.70/1.50	RX/TX
Q3007	2.04	11.77	2.67	
Q3008	0/0	0/2.67	0.7/0	RX/TX,MODE CW
Q3009	2.82/0	10.66/0	2.7/0	RX/TX,MODE CW
Q3010	0/5.14	0/10.45	0/5.76	RX/TX,MODE FM
Q3011	0.20	7.90	0.71	
Q3013	1.30	7.56	2.05	
Q3015	1.0	7.45	0	
Q3016	2.21	7.50	2.94	
Q3018	0.75	7.72	0.50	
Q3019	0.10	4.52	0.75	
Q3020	0.37	2.25	1.00	
Q3022	0.80	7.63	0.58	
Q3023	0.10	4.50	0.80	
Q3024	0.85	7.65	0	
Q3025	3.44	7.24	4.08	
Q3026	3.52	7.23	4.15	
Q3030	1.63	7.60	2.27	
Q3031	3.54	7.21	4.18	
Q3032	1.20	7.71	0.40	
Q3033	3.44	7.23	4.08	
Q3035	1.41	7.65	2.16	
Q3037	1.46	7.65	2.20	
Q3038	0.74	4.45	1.46	
Q3040	0.73	7.79	0.46	
Q3041	0.27	7.90	0.80	
Q3042	1.36	11.50	0	3.5MHz
Q3043	1.20	11.50	0	7MHz
Q3044	0.80	11.50	0	14MHz
Q3045	1.10	11.40	0	21MHz
Q3046	1.40	11.40	0	28MHz
Q3047	4.10	7.96	4.10	
Q3048	3.39	7.96	4.10	
Q3049	1.58	7.64	0	
Q3050	1.86	7.60	2.60	
Q3051	1.00	5.60	1.69	TRV ON
Q3053	12.20	12.20	11.50	MODE FSK
Q3054	12.30/12.30	11.59/11.49	11.68/11.58	RX/TX, MODE FM
Q3055	12.40/12.30	12.40/12.30	11.70/11.60	RX/TX, MODE AM
Q3056	12.30	12.20	11.60	MODE CW
Q3057	12.30	12.20	11.57	MODE USB
Q3058	12.30	12.20	11.58	MODE LSB
Q3059	12.30	12.20	11.58	
Q3060	0/13.06	0/13.02	0/12.30	RX/TX, MODE FM
Q3061	13.20/0	13.10/0	12.40/0	RX/TX, MODE CW
Q3062	13.20/0	13.20/0	12.50/0	RX/TX
Q3063	12.50	12.50	11.80	MODE FM
Q3064	0/13.00	0/13.00	0/12.40	RX/TX, TX SHIFT ON
Q3065	0/13.00	0/13.00	0/12.38	RX/TX, TX SHIFT OFF
Q3070	0	0	4.30	MIC DOWN
Q3071	0	0	4.30	MIC UP
Q3072	0	0	4.30	MIC FAST
Q3075	0/0	0/0	13.20/0	RX/TX, TONE SQL ON
Q3076	0/0	0/0	0/13.00	RX/TX, TONE ENC ON
Q3077	0/0	0/7.52	0/0	RX/TX
Q3081	12.20/12.20	12.32/12.20	11.64/11.54	RX/TX, 3.5MHz
Q3082	12.34/12.30	12.20/12.10	11.64/11.50	RX/TX, 7MHz
Q3083	12.34/12.30	12.20/12.10	11.60/11.50	RX/TX, 14MHz
Q3084	12.30/12.30	12.20/12.10	11.60/11.50	RX/TX, 21MHz
Q3085	12.30/12.30	12.20/12.10	11.60/11.50	RX/TX, 28MHz
Q3086	12.30/12.30	12.20/12.10	11.60/11.50	RX/TX, 1MHz
Q3088	4.90	11.56	10.93	1MHz
Q3089	0/0	0/0	0/13.10	RX/TX
Q3090	12.34	13.20	12.90	

LOCAL UNIT CIRCUIT DIAGRAM

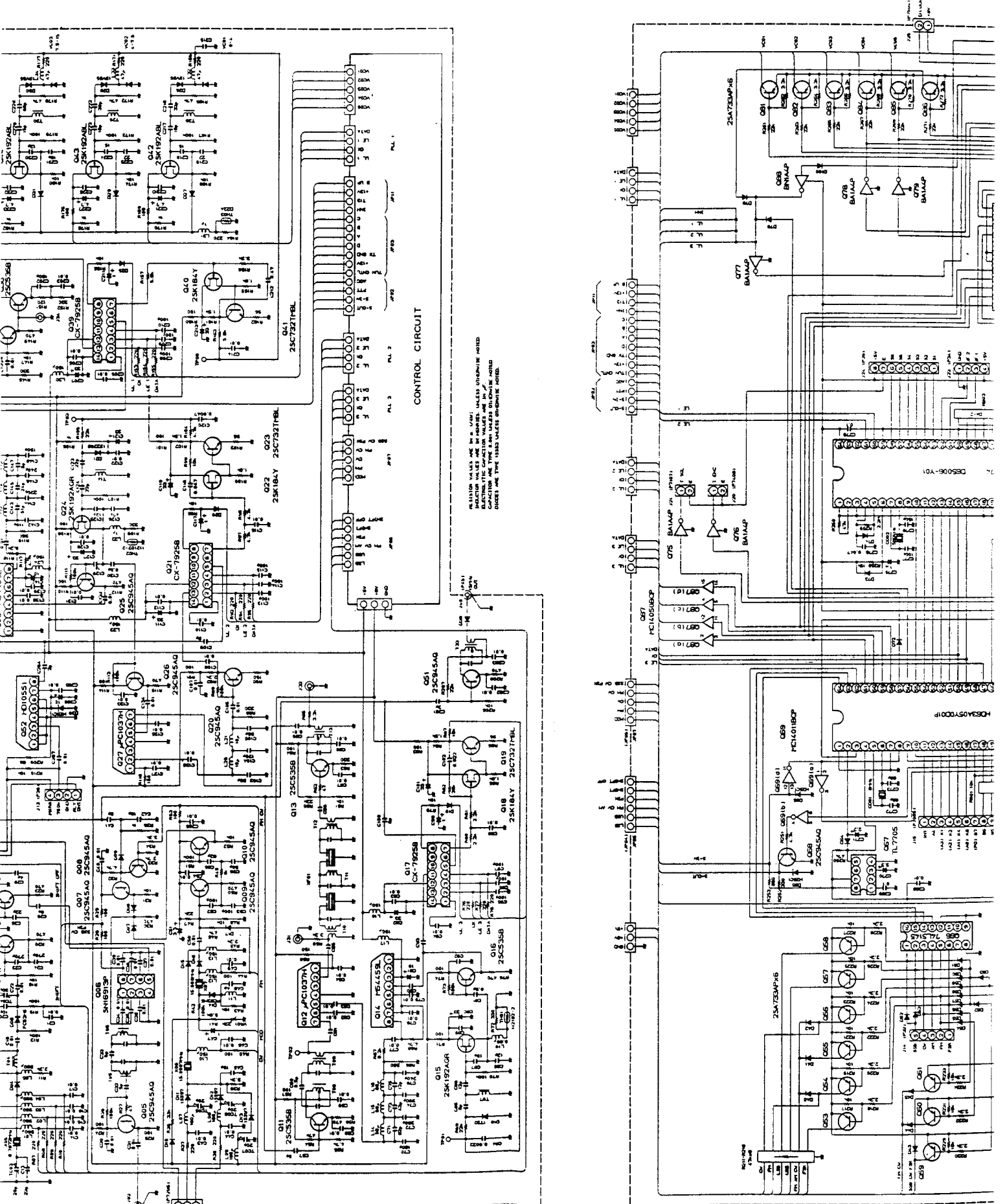

T CIRCUIT DIAGRAM

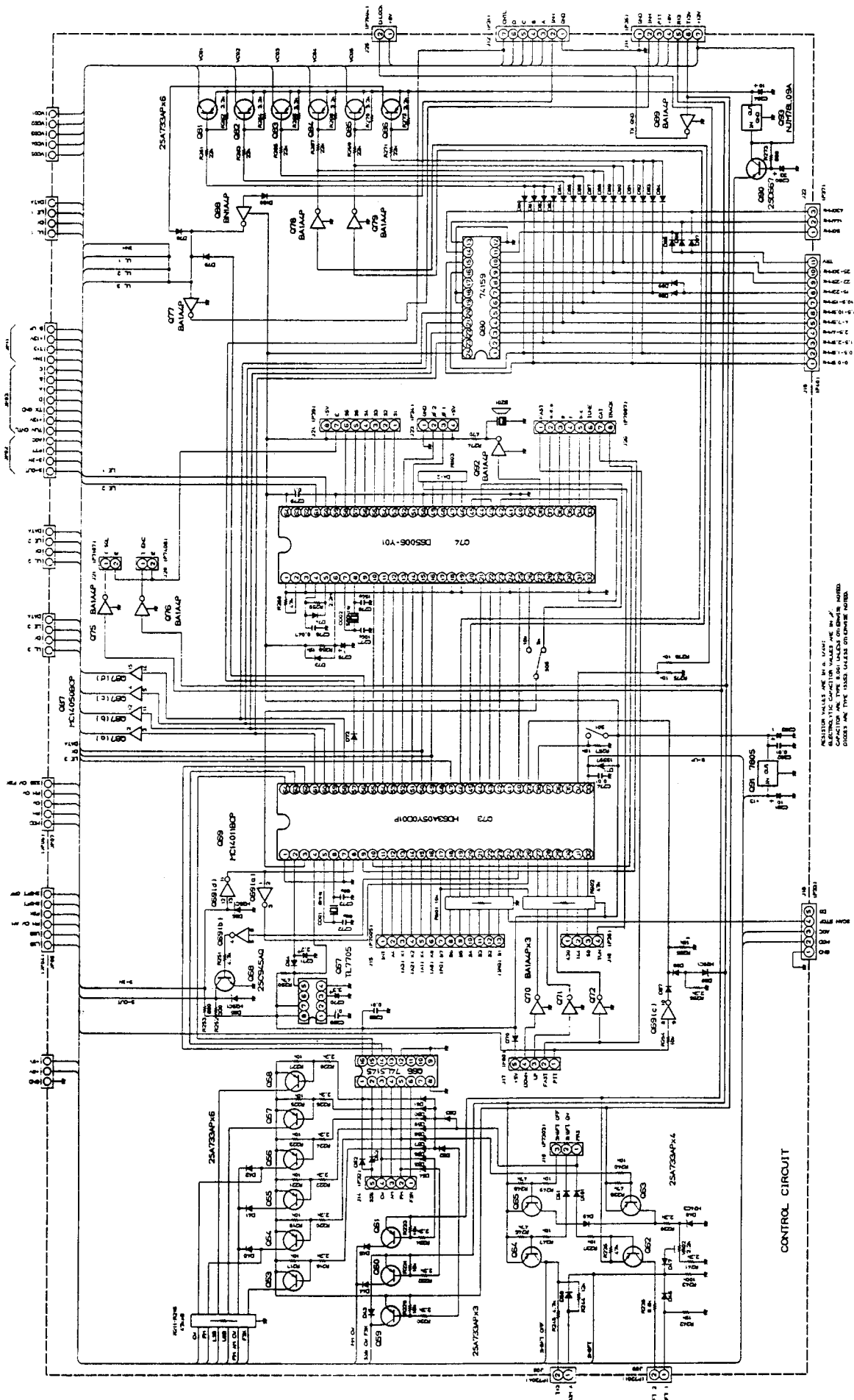

RESISTOR VALUES ARE IN OHMS UNLESS OTHERWISE SPECIFIED
 CAPACITOR VALUES ARE IN MICROFARADS UNLESS OTHERWISE SPECIFIED
 DIMENSIONS ARE THE USUAL VALUES ON THESE BOARDS

Make all measurements and adjustments while receiving in the CW mode, except where stated otherwise.

(1) 3rd Local Oscillator

Connect the RF voltmeter to J3002 and adjust T3005 and T3006 for maximum voltage (at least 30 mVrms).

(2) 2nd Local Level

Connect the RF voltmeter across J3001 (do not remove the plug) and adjust T3001, T3002 and T3003 for maximum RF (at least 40 mVrms).

(3) 2nd Local Frequency Check

Connect the frequency counter to pin 5 of Q3002 and confirm 30.030 MHz \pm 1 kHz.

(4) Carrier Oscillators

Make certain the SHIFT control is set to the 12 o'clock position. Connect the frequency counter to pin 5 of Q3006. Select each mode indicated in the following table, and adjust the indicated coil or trimmer for the indicated frequency on the counter \pm 10 Hz.

Mode	Adj. Point	Frequency (kHz)
CW	T3004	6784.100
LSB	TC3001	6786.600
USB	TC3002	6783.400
FSK	TC3003	6787.200

(5) Transmitter IF Shift

A 50-ohm dummy load must be connected to the ANT jack, as this step requires transmission for measurement and adjustment.

Set the TX SHIFT button OFF (out) and select the LSB mode. Set the TX SHIFT control to the 12 o'clock position. Connect the frequency counter to pin 5 of Q3006. Press the MOX button and adjust VR3002, if necessary, for 6786.6 kHz \pm 10 Hz on the counter. Now press the TX SHIFT button and adjust TC3004, if necessary, for the same indication on the counter.

(6) CW BFO Frequency

Select the CW mode and connect the frequency counter to pin 2 of Q3006. Set the PITCH selector and adjust the corresponding trimmer for the frequency indicated below (\pm 10 Hz).

Pitch	Adj. Point	Frequency (MHz)
800 Hz	TC3007	15.0008
700 Hz	TC3006	15.0007
600 Hz	TC3005	15.0006

(7) FM Carrier Frequency

A 50-ohm dummy load must be connected to the ANT jack, as this step requires transmission for measurement and adjustment.

Select the FM mode. With the frequency counter connected to pin 2 of Q3006, press the MOX button and adjust VR3001 for 15 MHz \pm 50 Hz.

(8) PLL-3 VCO

Tune the display to 14.2000.00. Connect the DC voltmeter to TP3001 and adjust T3007, if necessary, for 4.5 \pm 0.1V. Retune the display to 14.199.99 and check for 3 to 4V.

(9) 45 MHz Bandpass Filter

Tune to 14.250 MHz and connect the RF millivoltmeter TP3002. Adjust T3008 and T3009 for maximum RF (at least 60 mVrms).

(10) 15 MHz Reference TCXO

Connect the frequency counter to TP3002 and adjust the trimmer accessible through the hole in the TXCO housing for 45 MHz \pm 10 Hz.

(11) 46 MHz Bandpass Filter

Connect the tracking generator to J3031 and couple the spectrum analyzer to J3032. Adjust T3010-T3013 for the passband shown below (reducing injection level, if necessary, to avoid saturation).

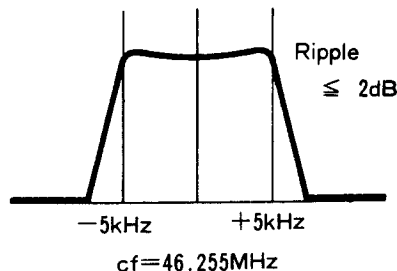

T
T
T
T
V
V
T

LOCAL UNIT ALIGNMENT

(6) CW BFO Frequency

Select the CW mode and connect the frequency counter to pin 2 of Q3006. Set the PITCH selector and adjust the corresponding trimmer for the frequency indicated below (± 10 Hz).

Pitch	Adj. Point	Frequency (MHz)
800 Hz	TC3007	15.0008
700 Hz	TC3006	15.0007
600 Hz	TC3005	15.0006

(7) FM Carrier Frequency

A 50-ohm dummy load must be connected to the ANT jack, as this step requires transmission for measurement and adjustment.

Select the FM mode. With the frequency counter connected to pin 2 of Q3006, press the MOX button and adjust VR3001 for 15 MHz ± 50 Hz.

(8) PLL-3 VCO

Tune the display to 14.2000.00. Connect the DC voltmeter to TP3001 and adjust T3007, if necessary, for 4.5 ± 0.1 V. Retune the display to 14.199.99 and check for 3 to 4V.

(9) 45 MHz Bandpass Filter

Tune to 14.250 MHz and connect the RF millivoltmeter TP3002. Adjust T3008 and T3009 for maximum RF (at least 60 mVrms).

(10) 15 MHz Reference TCXO

Connect the frequency counter to TP3002 and adjust the trimmer accessible through the hole in the TCXO housing for 45 MHz ± 10 Hz.

(11) 46 MHz Bandpass Filter

Connect the tracking generator to J3031 and couple the spectrum analyzer to J3032. Adjust T3010-T3013 for the passband shown below (reducing injection level, if necessary, to avoid saturation).

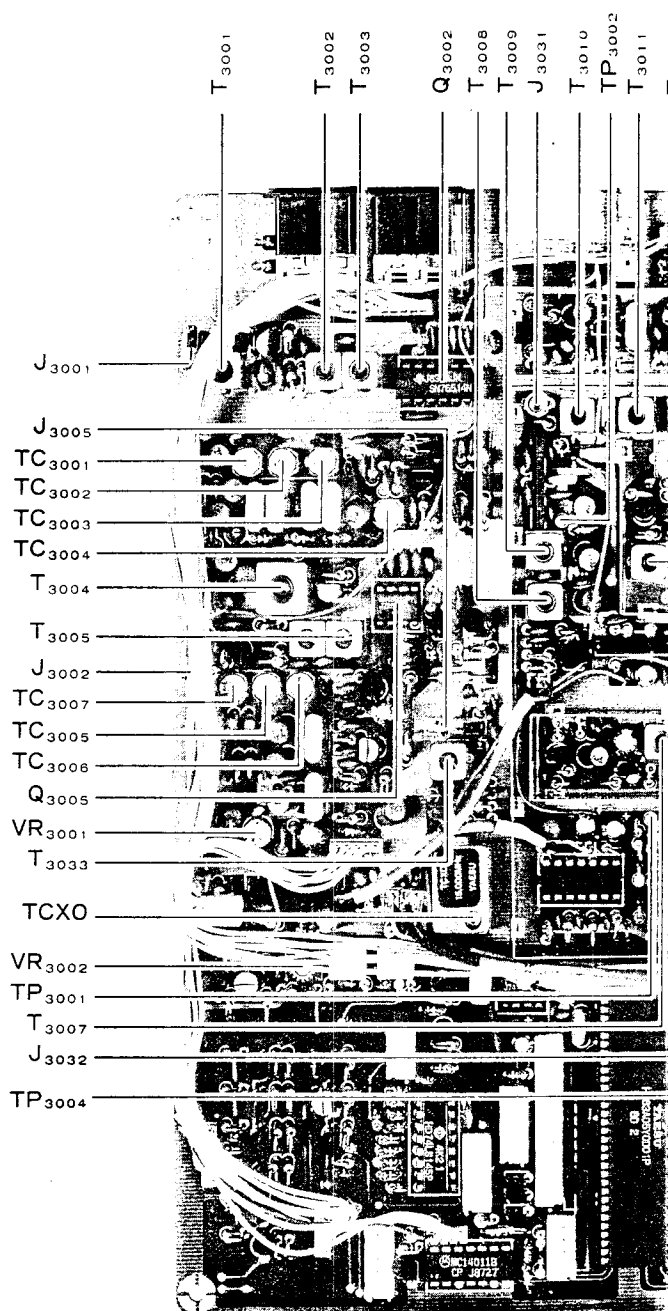
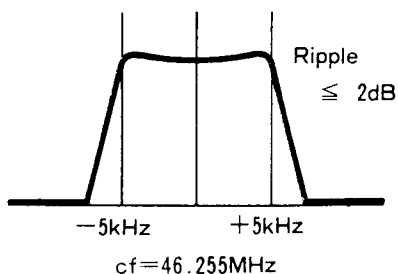

LOCAL UNIT

(12) PLL-2 VCO

Tune the display to 14.199.99. Connect the voltmeter to TP3003 and adjust T3004, if necessary, for 5.5 ± 0.1 V. Retune the display to 14.000.00 and check for 2.5 to 4.0V.

UNIT ALIGNMENT

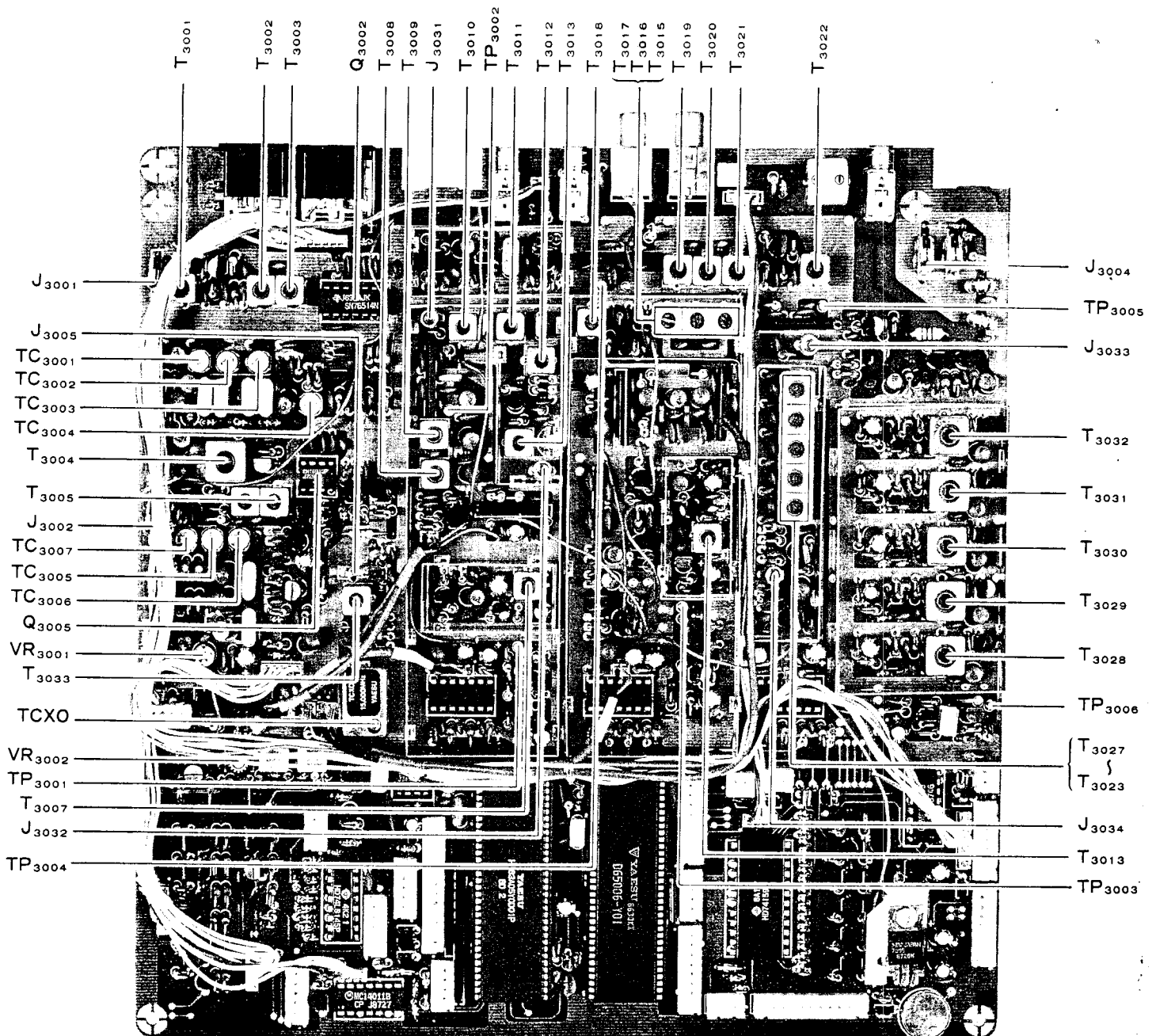

LOCAL UNIT ALIGNMENT POINTS

(12) PLL-2 VCO

Tune the display to 14.199.99. Connect the DC voltmeter to TP3003 and adjust T3004, if necessary, for $5.5 \pm 0.1V$. Retune the display to 14.000.00 and check for 2.5 to 4.0V.

LOCAL UNIT ALIGNMENT

(13) 13 MHz Bandpass Filter

Tune to 14.250 MHz and connect the RF millivoltmeter to TP3004. Adjust T3015 through T3018 for maximum RF (at least 40 mVrms).

(14) 43 MHz Bandpass Filter

Tune to 14.250 MHz and connect the RF millivoltmeter to TP3005. Adjust T3019 through T3022 for maximum RF (at least 40 mVrms).

(15) Main Loop Lowpass Filter

Connect the tracking generator to J3033 and couple the spectrum analyzer to J3034. Adjust T3023 through T3027 for the roll-off shown (reducing injection level, if necessary, to avoid saturation).

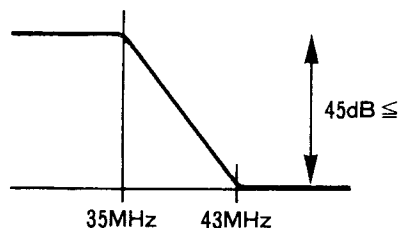

(16) Main Loop VCOs

Set the display to 3.999.99. Connect the high-impedance DC voltmeter to TP3006 and adjust transformer T3028 for 6.0 \pm 0.1V. Retune the display to 0.000.00 and confirm 1 to 2V. Repeat the same procedure for the same voltages at the following frequencies:

<u>Display</u>	<u>Xfmr</u>	<u>Confirm</u>
7.499.99	T3029	4.000.00
14.999.99	T3030	7.500.00
21.999.99	T3031	15.000.00
29.999.99	T3032	22.000.00

Check that the voltage at TP3006 increases smoothly from 1.0 to about 6.5V when tuning from 0 to 7.499 MHz, 7.5 to 14.999 MHz, 15 to 21.999 MHz and 22 to 29.999 MHz.

(17) SSB Carrier Point Check (Transmit)

A 50-ohm dummy load and wattmeter must be connected to the ANT jack, as this step requires transmission for measurement and adjustment.

Tune to 14.200 MHz, USB mode. Connect the AF generator to the center pin of the MIC jack, and set for 5 mV output at 1 kHz. Press the MOX button and adjust the MIC gain control for 80W RF output.

Reduce the AF generator frequency until 20W RF output is obtained, and note the corresponding audio frequency. Now increase the AF frequency until 20W RF output is again obtained, and again note the corresponding audio frequency.

The lower frequency should be below 350 Hz, and the upper frequency should be above 2900 Hz. If not, perform procedures (4) and (5), and repeat this procedure.

Repeat the above in LSB mode.

(18) 1st Local Level Check

Tune to 14.200.00. Connect the RF millivoltmeter to J3004 (do not remove the plug) and confirm at least 100 mVrms.

(19) VHF/UHF Module Reference Level

Set the transceiver to the 50 MHz band. Connect the RF voltmeter to J3005 (don't remove the plug) and adjust T3033 for 150 mVrms.

LOCAL UNIT PARTS LIST

*** LOCAL UNIT ***			PCB with Components		Printed Circuit Board	
Q3001	C030130AA	F3013000	Transistor	IC	2SC535B	Q3057
Q3002	G1090062	G3107331P	IC	SN76514N	Q3058	
Q3003	G3305350B	G3107331P	Transistor	2SC535B	Q3059	
Q3004	G3309451Q	G3107331P	Transistor	2SC945AQ	Q3060	
Q3005	G3309451Q	G3107331P	Transistor	2SC945AQ	Q3061	
Q3006	G1090012	G3107331P	IC	SN16913P	Q3062	
Q3007	G3309451Q	G3107331P	Transistor	2SC945AQ	Q3063	
Q3008	G3309451Q	G3107331P	Transistor	2SC945AQ	Q3064	
Q3009	G3309451Q	G3107331P	Transistor	2SC945AQ	Q3065	
Q3010	G3309451Q	G3107331P	Transistor	2SC945AQ	Q3066	
Q3011	G3305350B	G3107331P	Transistor	2SC535B	Q3067	
Q3012	G1090101	G3107331P	IC	uPC1037H	Q3068	
Q3013	G3305350B	G1090395	Transistor	2SC535B	Q3069	
Q3014	G1090838	G1090549	IC	M54459L	Q3070	
Q3015	G3801921G	G3090079	FET	2SK192AGR	Q3071	
Q3016	G3305350B	G3090079	Transistor	2SC535B	Q3072	
Q3017	G1090834	G3090079	IC	CX7925B	Q3073	
Q3018	G3801840Y	G1090909	FET	2SK184Y	Q3074	
Q3019	G3307320B	G3090079	Transistor	2SC732TMBL	Q3075	
Q3020	G3309451Q	G3090079	Transistor	2SC945AQ	Q3076	
Q3021	G1090834	G1090718	IC	CX7925B	Q3077	
Q3022	G3801840Y	G3090079	FET	2SK184Y	Q3078	
Q3023	G3307320B	G1090719	Transistor	2SC732TMBL	Q3079	
Q3024	G3801921G	G3090075	FET	2SK192AGR	Q3080	
Q3025	G3309451Q	G3090075	Transistor	2SC945AQ	Q3081	
Q3026	G3309451Q	G34066670C	Transistor	2SC945AQ	Q3082	
Q3027	G1090101	G1090299	IC	uPC1037H	Q3083	
Q3028	G1090838	G1090118	IC	M54459L	Q3084	
Q3029	G1090101	G2090027	IC	uPC1037H	Q3085	
Q3030	G3309451Q	G2090118	Transistor	2SC945AQ	Q3086	
Q3031	G3309451Q	G2090027	Transistor	2SC945AQ	Q3087	
Q3032	G3801921G	G2090027	FET	2SK192AGR	Q3088	
Q3033	G3309451Q	G2090118	Transistor	2SC945AQ	Q3089	
Q3034	G1090101	G2090165	IC	uPC1037H	Q3090	
Q3035	G3305350B	G2090027	IC	G3305350B	Q3091	
Q3036	G1090101	G2090027	IC	G1090118	Q3092	
Q3037	G3305350B	G2090027	Transistor	G2090027	Q3093	
Q3038	G3305350B	G2090118	Transistor	G2090118	D3001	
Q3039	G1090834	G2090165	IC	CX7925B	D3002	
Q3040	G3801840Y	G2090027	FET	2SK184Y	D3003	
Q3041	G3307320B	G2090027	Transistor	2SC732TMBL	D3004	
Q3042	G3801921B	G2090027	FET	2SK192ABL	D3005	
Q3043	G3801921B	G2090118	FET	2SK192ABL	D3006	
Q3044	G3801921B	G2090118	FET	2SK192ABL	D3007	
Q3045	G3801921B	G2090118	FET	2SK192ABL	D3008	
Q3046	G3801921B	G2090118	FET	2SK192ABL	D3009	
Q3047	G3305350B	G2090180	Transistor	2SC535B	D3010	
Q3048	G3305350B	G2090027	Transistor	2SC535B	D3011	
Q3049	G3801921G	G2090027	FET	2SK192AGR	D3012	
Q3050	G3305350B	G2090027	Transistor	2SC535B	D3013	
Q3051	G3309451Q	G2090248	Transistor	2SC945AQ	D3014	
Q3052	G1090296	G2090027	IC	HDI0551	D3015	
Q3053	G3107331P	G2090027	Transistor	2SA733AP	D3016	
Q3054	G3107331P	G2090027	Transistor	2SA733AP	D3017	
Q3055	G3107331P	G2090027	Transistor	2SA733AP	D3018	
Q3056	G3107331P	G2090027	Transistor	2SA733AP	D3019	

Q3057	G3107331P	Transistor	2SA733AP
Q3058	G3107331P	Transistor	2SA733AP
Q3059	G3107331P	Transistor	2SA733AP
Q3060	G3107331P	Transistor	2SA733AP
Q3061	G3107331P	Transistor	2SA733AP
Q3062	G3107331P	Transistor	2SA733AP
Q3063	G3107331P	Transistor	2SA733AP
Q3064	G3107331P	Transistor	2SA733AP
Q3065	G3107331P	Transistor	2SA733AP
Q3066	G1090395	IC	SN74LS145N
Q3067	G1090549	IC	TL7705CP-B
Q3068	G3309451Q	IC	2SC945AQ
Q3069	G1090068	IC	MC14011BCP
Q3070	G3090079	Transistor	BA1A4P
Q3071	G3090079	Transistor	BA1A4P
Q3072	G3090079	Transistor	BA1A4P
Q3073	G1090909	IC	HD63A05Y0D01P
Q3074	G1090718	IC	uPD65006-Y01
Q3075	G3090079	Transistor	BA1A4P
Q3076	G3090079	Transistor	BA1A4P
Q3077	G3090079	Transistor	BA1A4P
Q3078	G3090079	Transistor	BA1A4P
Q3079	G3090079	Transistor	BA1A4P
Q3080	G1090719	IC	SN74159N
Q3081	G3107331P	Transistor	2SA733AP
Q3082	G3107331P	Transistor	2SA733AP
Q3083	G3107331P	Transistor	2SA733AP
Q3084	G3107331P	Transistor	2SA733AP
Q3085	G3107331P	Transistor	2SA733AP
Q3086	G3107331P	Transistor	2SA733AP
Q3087	G1090166	IC	MC14050BCP
Q3088	G3090075	Transistor	BN1A4P
Q3089	G3090079	Transistor	BA1A4P
Q3090	G34066670C	Transistor	2SD667C
Q3091	G1090299	IC	uPC7805H
Q3092	G3090079	IC	BA1A4P
Q3093	G1090118	IC	NJM78L09A
D3001	G2090027	DIODE	1SS53
D3002	G2090118	DIODE	1SS97
D3003	G2090027	DIODE	1SS53
D3004	G2090027	DIODE	1SS53
D3005	G2090118	DIODE	1SS97
D3006	G2090165	DIODE	FC52M-5
D3007	G2090027	DIODE	1SS53
D3008	G2090027	DIODE	1SS53
D3009	G2090027	DIODE	1SS53
D3010	G2090027	DIODE	1SS53
D3011	G2090118	DIODE	1SS97
D3012	G2090118	DIODE	1SS97
D3013	G2090118	DIODE	1SS97
D3014	G2090180	DIODE	FC53M-5
D3015	G2090027	DIODE	1SS53
D3016	G2090027	DIODE	1SS53
D3017	G2090027	DIODE	1SS53
D3018	G2090248	DIODE	1T32
D3019	G2090027	DIODE	1SS53
D3020	G2090027	DIODE	1SS53
D3021	G2022080	DIODE	1S2208
D3022	G2090027	DIODE	1SS53
D3023	G2090027	DIODE	1SS53

LOCAL UNIT PARTS LIST

D3024	G2090118	DIODE	1SS97
D3025	G2090027	DIODE	1SS53
D3026	G2090161	DIODE	1SV55
D3027	G2090027	DIODE	1SS53
D3028	G2090161	DIODE	1SV55
D3029	G2090027	DIODE	1SS53
D3030	G2090161	DIODE	1SV55
D3031	G2090027	DIODE	1SS53
D3032	G2090161	DIODE	1SV55
D3033	G2090027	DIODE	1SS53
D3034	G2090161	DIODE	1SV55
D3035	G2090027	DIODE	1SS53
D3036	G2090118	DIODE	1SS97
D3037	G2090118	DIODE	1SS97
D3038	G2090027	DIODE	1SS53
D3039	G2090188	DIODE	HZ5C1
D3040	G2090027	DIODE	1SS53
D3041	G2090027	DIODE	1SS53
D3042	G2090027	DIODE	1SS53
D3043	G2090027	DIODE	1SS53
D3044	G2090027	DIODE	1SS53
D3045	G2090027	DIODE	1SS53
D3046	G2090027	DIODE	1SS53
D3047	G2090027	DIODE	1SS53
D3048	G2090226	DIODE	HZ4C3
D3049	G2090027	DIODE	1SS53
D3050	G2090027	DIODE	1SS53
D3051	G2090027	DIODE	1SS53
D3052	G2090027	DIODE	1SS53
D3053	G2090027	DIODE	1SS53
D3054	G2090027	DIODE	1SS53
D3055	G2090027	DIODE	1SS53
D3056	G2090027	DIODE	1SS53
D3057	G2090027	DIODE	1SS53
D3058	G2090027	DIODE	1SS53
D3059	G2090027	DIODE	1SS53
D3060	G2090027	DIODE	1SS53
D3061	G2090027	DIODE	1SS53
D3062	G2090027	DIODE	1SS53
D3063	G2090027	DIODE	1SS53
D3064	G2090027	DIODE	1SS53
D3065	G2090188	DIODE	HZ5C1
D3066	G2090188	DIODE	HZ5C1
D3067	G2090027	DIODE	1SS53
D3068	G2090027	DIODE	1SS53
D3069	G2090218	DIODE	HZ9C1
D3070	G2090027	DIODE	1SS53
D3071	G2090118	DIODE	1SS53
D3072	G2090027	DIODE	1SS53
D3073	G2090027	DIODE	1SS53
D3074	G2090027	DIODE	1SS53
D3075	G2090027	DIODE	1SS53
D3076	G2090027	DIODE	1SS53
D3077	G2090027	DIODE	1SS53
D3078	G2090027	DIODE	1SS53
D3079	G2090027	DIODE	1SS53
D3080	G2090027	DIODE	1SS53
D3081	G2090027	DIODE	1SS53
D3082	G2090027	DIODE	1SS53
D3083	G2090027	DIODE	1SS53
D3084	G2090027	DIODE	1SS53
D3085	G2090027	DIODE	1SS53
D3086	G2090027	DIODE	1SS53
D3087	G2090027	DIODE	1SS53
D3088	G2090027	DIODE	1SS53
D3089	G2090027	DIODE	1SS53
D3090	G2090027	DIODE	1SS53
D3091	G2090027	DIODE	1SS53
D3092	G2090027	DIODE	1SS53
D3093	G2090027	DIODE	1SS53
D3094	G2090027	DIODE	1SS53
D3095	G2090027	DIODE	1SS53
D3096	G2090027	DIODE	1SS53
D3097	G2090027	DIODE	1SS53
D3098	G2090027	DIODE	1SS53
D3100	G2090027	DIODE	1SS53
D3101	G2090027	DIODE	1SS53
D3102	G2090118	DIODE	1SS97
TH3001	G9090008	Thermistor	112102-2
TH3002	G9090008	Thermistor	112102-2
TH3003	G9090002	Thermistor	D22A
XF3001	H1102068	Crystal Filter	-46G2B2
X3001	H0102703	Crystal	HC-19/U
X3002	H0102556A	Crystal	HC-18/U
X3003	H0102700	Crystal	HC-18/U
X3004	H0102701	Crystal	HC-18/U
X3005	H0102702	Crystal	HC-18/U
X3006	H9500060	Crystal	H-GF1502
X3007	H0102554A	Crystal	HC-18/U
X3008	H0102553B	Crystal	HC-18/U
CO3001	H7900490	Ceramic Resonator	6MHz
CO3002	H7900460	Ceramic Resonator	580KHz
R3001	J02245101	Carbon Film Res.	100 Ohm
R3002	J02245471	Carbon Film Res.	470 Ohm
R3003	J02245470	Carbon Film Res.	47 Ohm
R3004	J02245223	Carbon Film Res.	22k Ohm
R3005	J02245103	Carbon Film Res.	10k Ohm
R3006	J02245101	Carbon Film Res.	100 Ohm
R3007	J02245221	Carbon Film Res.	220 Ohm
R3008	J02245221	Carbon Film Res.	220 Ohm
R3009	J02245221	Carbon Film Res.	220 Ohm
R3010	J02245221	Carbon Film Res.	220 Ohm
R3011	J02245222	Carbon Film Res.	2.2k Ohm
R3012	J02245562	Carbon Film Res.	5.6k Ohm
R3013	J02245104	Carbon Film Res.	100k Ohm
R3014	J02245473	Carbon Film Res.	47k Ohm
R3015	J02245104	Carbon Film Res.	100k Ohm
R3016	J02245471	Carbon Film Res.	470 Ohm
R3017	J02245223	Carbon Film Res.	22k Ohm
R3018	J02245103	Carbon Film Res.	10k Ohm
R3019	J02245101	Carbon Film Res.	100 Ohm
R3020	J02245471	Carbon Film Res.	470 Ohm
R3021	J02245104	Carbon Film Res.	100k Ohm
R3022	J02245101	Carbon Film Res.	100 Ohm
R3023	J02245471	Carbon Film Res.	470 Ohm
R3024	J02245101	Carbon Film Res.	100 Ohm
R3025	J02245101	Carbon Film Res.	100 Ohm
R3026	J02245104	Carbon Film Res.	100k Ohm
R3027	J02245470	Carbon Film Res.	47 Ohm

LOCAL UNIT PARTS LIST

R3028	J02245101	Carbon Film Res.	100 Ohm	1/4W
R3029	J02245101	Carbon Film Res.	100 Ohm	1/4W
R3030	J02245471	Carbon Film Res.	470 Ohm	1/4W
R3031	J02245103	Carbon Film Res.	10k Ohm	1/4W
R3032	J02245472	Carbon Film Res.	4.7k Ohm	1/4W
R3033	J02245272	Carbon Film Res.	2.7k Ohm	1/4W
R3034	J02245332	Carbon Film Res.	3.3k Ohm	1/4W
R3035	J02245102	Carbon Film Res.	1k Ohm	1/4W
R3036	J02245333	Carbon Film Res.	33k Ohm	1/4W
R3037	J02245221	Carbon Film Res.	220 Ohm	1/4W
R3038	J02245221	Carbon Film Res.	220 Ohm	1/4W
R3039	J02245332	Carbon Film Res.	3.3k Ohm	1/4W
R3040	J02245101	Carbon Film Res.	100 Ohm	1/4W
R3041	J02245562	Carbon Film Res.	5.6k Ohm	1/4W
R3042	J02245104	Carbon Film Res.	100k Ohm	1/4W
R3043	J02245103	Carbon Film Res.	10k Ohm	1/4W
R3044	J02245101	Carbon Film Res.	100 Ohm	1/4W
R3045	J02245222	Carbon Film Res.	2.2k Ohm	1/4W
R3046	J02245473	Carbon Film Res.	47k Ohm	1/4W
R3047	J02245223	Carbon Film Res.	22k Ohm	1/4W
R3048	J02245103	Carbon Film Res.	10k Ohm	1/4W
R3049	J02245102	Carbon Film Res.	1k Ohm	1/4W
R3050	J02245471	Carbon Film Res.	470 Ohm	1/4W
R3051	J02245104	Carbon Film Res.	100k Ohm	1/4W
R3052	J02245103	Carbon Film Res.	10k Ohm	1/4W
R3053	J02245101	Carbon Film Res.	100 Ohm	1/4W
R3054	J02245473	Carbon Film Res.	47k Ohm	1/4W
R3055	J02245472	Carbon Film Res.	4.7k Ohm	1/4W
R3056	J02245471	Carbon Film Res.	470 Ohm	1/4W
R3057	J02245101	Carbon Film Res.	100 Ohm	1/4W
R3058	J02245151	Carbon Film Res.	150 Ohm	1/4W
R3059	J02245332	Carbon Film Res.	3.3k Ohm	1/4W
R3060	J02245223	Carbon Film Res.	22k Ohm	1/4W
R3061	J02245103	Carbon Film Res.	10k Ohm	1/4W
R3062	J02245470	Carbon Film Res.	47 Ohm	1/4W
R3063	J02245331	Carbon Film Res.	330 Ohm	1/4W
R3064	J02245101	Carbon Film Res.	100 Ohm	1/4W
R3065	J02245332	Carbon Film Res.	3.3k Ohm	1/4W
R3066	J02245561	Carbon Film Res.	560 Ohm	1/4W
R3067	J02245822	Carbon Film Res.	8.2k Ohm	1/4W
R3068	J02245472	Carbon Film Res.	4.7k Ohm	1/4W
R3069	J02245223	Carbon Film Res.	22k Ohm	1/4W
R3070	J02245104	Carbon Film Res.	100k Ohm	1/4W
R3071	J02245101	Carbon Film Res.	100 Ohm	1/4W
R3072	J02245331	Carbon Film Res.	330 Ohm	1/4W
R3073	J02245104	Carbon Film Res.	100k Ohm	1/4W
R3074	J02245101	Carbon Film Res.	100 Ohm	1/4W
R3075	J02245471	Carbon Film Res.	470 Ohm	1/4W
R3076	J02245221	Carbon Film Res.	220 Ohm	1/4W
R3077	J02245221	Carbon Film Res.	220 Ohm	1/4W
R3078	J02245221	Carbon Film Res.	220 Ohm	1/4W
R3079	J02245103	Carbon Film Res.	10k Ohm	1/4W
R3080	J02245222	Carbon Film Res.	2.2k Ohm	1/4W
R3081	J02245222	Carbon Film Res.	2.2k Ohm	1/4W
R3082	J02245393	Carbon Film Res.	39k Ohm	1/4W
R3083	J02245101	Carbon Film Res.	100 Ohm	1/4W
R3084	J02245152	Carbon Film Res.	1.5k Ohm	1/4W
R3085	J02245182	Carbon Film Res.	1.8k Ohm	1/4W
R3086	J02245560	Carbon Film Res.	56 Ohm	1/4W
R3087	J02245103	Carbon Film Res.	10k Ohm	1/4W
R3088	J02245331	Carbon Film Res.	330 Ohm	1/4W
R3089	J02245104	Carbon Film Res.	100k Ohm	1/4W
R3090	J02245151	Carbon Film Res.	150 Ohm	1/4W
R3091	J02245101	Carbon Film Res.	100 Ohm	1/4W
R3092	J02245222	Carbon Film Res.	2.2k Ohm	1/4W
R3093	J02245221	Carbon Film Res.	220 Ohm	1/4W
R3094	J02245221	Carbon Film Res.	220 Ohm	1/4W
R3095	J02245221	Carbon Film Res.	220 Ohm	1/4W
R3096	J02245103	Carbon Film Res.	10k Ohm	1/4W
R3097	J02245472	Carbon Film Res.	4.7k Ohm	1/4W
R3098	J02245472	Carbon Film Res.	4.7k Ohm	1/4W
R3099	J02245103	Carbon Film Res.	10k Ohm	1/4W
R3100	J02245182	Carbon Film Res.	1.8k Ohm	1/4W
R3101	J02245101	Carbon Film Res.	100 Ohm	1/4W
R3102	J02245152	Carbon Film Res.	1.5k Ohm	1/4W
R3103	J02245560	Carbon Film Res.	56 Ohm	1/4W
R3104	J02245472	Carbon Film Res.	4.7k Ohm	1/4W
R3105	J02245223	Carbon Film Res.	22k Ohm	1/4W
R3106	J02245102	Carbon Film Res.	1k Ohm	1/4W
R3107	J02245104	Carbon Film Res.	100k Ohm	1/4W
R3108	J02245101	Carbon Film Res.	100 Ohm	1/4W
R3109	J02245331	Carbon Film Res.	330 Ohm	1/4W
R3110	J02245101	Carbon Film Res.	100 Ohm	1/4W
R3111	J02245104	Carbon Film Res.	100k Ohm	1/4W
R3112	J02245471	Carbon Film Res.	470 Ohm	1/4W
R3113	J02245104	Carbon Film Res.	100k Ohm	1/4W
R3114	J02245101	Carbon Film Res.	100 Ohm	1/4W
R3115	J02245471	Carbon Film Res.	470 Ohm	1/4W
R3116	J02245151	Carbon Film Res.	150 Ohm	1/4W
R3117	J02245472	Carbon Film Res.	4.7k Ohm	1/4W
R3118	J02245822	Carbon Film Res.	8.2k Ohm	1/4W
R3119	J02245561	Carbon Film Res.	560 Ohm	1/4W
R3120	J02245151	Carbon Film Res.	150 Ohm	1/4W
R3121	J02245223	Carbon Film Res.	22k Ohm	1/4W
R3122	J02245103	Carbon Film Res.	10k Ohm	1/4W
R3123	J02245470	Carbon Film Res.	47 Ohm	1/4W
R3124	J02245471	Carbon Film Res.	470 Ohm	1/4W
R3125	J02245101	Carbon Film Res.	100 Ohm	1/4W
R3126	J02245101	Carbon Film Res.	100 Ohm	1/4W
R3127	J02245471	Carbon Film Res.	470 Ohm	1/4W
R3128	J02245104	Carbon Film Res.	100k Ohm	1/4W
R3129	J02245473	Carbon Film Res.	47k Ohm	1/4W
R3130	J02245101	Carbon Film Res.	100 Ohm	1/4W
R3131	J02245471	Carbon Film Res.	470 Ohm	1/4W
R3132	J02245104	Carbon Film Res.	100k Ohm	1/4W
R3133	J02245101	Carbon Film Res.	100 Ohm	1/4W
R3134	J02245471	Carbon Film Res.	470 Ohm	1/4W
R3135	J02245103	Carbon Film Res.	10k Ohm	1/4W
R3136	J02245151	Carbon Film Res.	150 Ohm	1/4W
R3137	J02245223	Carbon Film Res.	22k Ohm	1/4W
R3138	J02245103	Carbon Film Res.	10k Ohm	1/4W
R3139	J02245470	Carbon Film Res.	47 Ohm	1/4W
R3140	J02245471	Carbon Film Res.	470 Ohm	1/4W
R3141	J02245101	Carbon Film Res.	100 Ohm	1/4W
R3142	J02245103	Carbon Film Res.	10k Ohm	1/4W
R3143	J02245151	Carbon Film Res.	150 Ohm	1/4W
R3144	J02245332	Carbon Film Res.	3.3k Ohm	1/4W
R3145	J02245331	Carbon Film Res.	330 Ohm	1/4W
R3146	J02245223	Carbon Film Res.	22k Ohm	1/4W
R3147	J02245103	Carbon Film Res.	10k Ohm	1/4W
R3148	J02245101	Carbon Film Res.	100 Ohm	1/4W
R3149	J02245471	Carbon Film Res.	470 Ohm	1/4W
R3150	J02245102	Carbon Film Res.	1k Ohm	1/4W
R3151	J02245121	Carbon Film Res.	120 Ohm	1/4W

LOCAL UNIT PARTS LIST

R3152	J02245331	Carbon Film Res.	330 Ohm	1/4W	R3214	J02245473	Carbon Film Res.	47k Ohm	1/4W
R3153	J02245291	Carbon Film Res.	220 Ohm	1/4W	R3215	J02245473	Carbon Film Res.	47k Ohm	1/4W
R3154	J02245221	Carbon Film Res.	220 Ohm	1/4W	R3216	J02245473	Carbon Film Res.	47k Ohm	1/4W
R3155	J02245231	Carbon Film Res.	220 Ohm	1/4W	R3217	J02245103	Carbon Film Res.	10k Ohm	1/4W
R3156	J02245103	Carbon Film Res.	10k Ohm	1/4W	R3218	J02245222	Carbon Film Res.	2.2k Ohm	1/4W
R3157	J02245562	Carbon Film Res.	5.6k Ohm	1/4W	R3219	J02245103	Carbon Film Res.	10k Ohm	1/4W
R3158	J02245332	Carbon Film Res.	3.3k Ohm	1/4W	R3220	J02245222	Carbon Film Res.	2.2k Ohm	1/4W
R3159	J02245182	Carbon Film Res.	1.8k Ohm	1/4W	R3221	J02245103	Carbon Film Res.	10k Ohm	1/4W
R3160	J02245101	Carbon Film Res.	100 Ohm	1/4W	R3222	J02245222	Carbon Film Res.	2.2k Ohm	1/4W
R3161	J02245152	Carbon Film Res.	1.5k Ohm	1/4W	R3223	J02245103	Carbon Film Res.	10k Ohm	1/4W
R3162	J02245560	Carbon Film Res.	56 Ohm	1/4W	R3224	J02245222	Carbon Film Res.	2.2k Ohm	1/4W
R3163	J02245562	Carbon Film Res.	5.6k Ohm	1/4W	R3225	J02245103	Carbon Film Res.	10k Ohm	1/4W
R3164	J02245221	Carbon Film Res.	220 Ohm	1/4W	R3226	J02245222	Carbon Film Res.	2.2k Ohm	1/4W
R3165	J02245231	Carbon Film Res.	220 Ohm	1/4W	R3227	J02245103	Carbon Film Res.	10k Ohm	1/4W
R3166	J02245473	Carbon Film Res.	47k Ohm	1/4W	R3228	J02245222	Carbon Film Res.	2.2k Ohm	1/4W
R3167	J02245104	Carbon Film Res.	100k Ohm	1/4W	R3229	J02245103	Carbon Film Res.	10k Ohm	1/4W
R3168	J02245103	Carbon Film Res.	10k Ohm	1/4W	R3230	J02245222	Carbon Film Res.	2.2k Ohm	1/4W
R3169	J02245101	Carbon Film Res.	10k Ohm	1/4W	R3231	J02245103	Carbon Film Res.	10k Ohm	1/4W
R3170	J02245102	Carbon Film Res.	100 Ohm	1/4W	R3232	J02245222	Carbon Film Res.	2.2k Ohm	1/4W
R3171	J02245221	Carbon Film Res.	1k Ohm	1/4W	R3233	J02245103	Carbon Film Res.	10k Ohm	1/4W
R3172	J02245473	Carbon Film Res.	220 Ohm	1/4W	R3234	J02245222	Carbon Film Res.	2.2k Ohm	1/4W
R3173	J02245104	Carbon Film Res.	47k Ohm	1/4W	R3235	J02245473	Carbon Film Res.	47k Ohm	1/4W
R3174	J02245103	Carbon Film Res.	100k Ohm	1/4W	R3236	J02245682	Carbon Film Res.	6.8k Ohm	1/4W
R3175	J02245101	Carbon Film Res.	10k Ohm	1/4W	R3237	J02245103	Carbon Film Res.	10k Ohm	1/4W
R3176	J02245102	Carbon Film Res.	100 Ohm	1/4W	R3238	J02245473	Carbon Film Res.	47k Ohm	1/4W
R3177	J02245221	Carbon Film Res.	1k Ohm	1/4W	R3239	J02245222	Carbon Film Res.	2.2k Ohm	1/4W
R3178	J02245473	Carbon Film Res.	220 Ohm	1/4W	R3240	J02245103	Carbon Film Res.	10k Ohm	1/4W
R3179	J02245104	Carbon Film Res.	47k Ohm	1/4W	R3241	J02245222	Carbon Film Res.	2.2k Ohm	1/4W
R3180	J02245103	Carbon Film Res.	100k Ohm	1/4W	R3242	J02245153	Carbon Film Res.	15k Ohm	1/4W
R3181	J02245101	Carbon Film Res.	10k Ohm	1/4W	R3243	J02245104	Carbon Film Res.	100k Ohm	1/4W
R3182	J02245102	Carbon Film Res.	100 Ohm	1/4W	R3244	J02245123	Carbon Film Res.	12k Ohm	1/4W
R3183	J02245221	Carbon Film Res.	220 Ohm	1/4W	R3245	J02245472	Carbon Film Res.	4.7k Ohm	1/4W
R3184	J02245473	Carbon Film Res.	47k Ohm	1/4W	R3246	J02245473	Carbon Film Res.	47k Ohm	1/4W
R3185	J02245104	Carbon Film Res.	10k Ohm	1/4W	R3247	J02245103	Carbon Film Res.	10k Ohm	1/4W
R3186	J02245103	Carbon Film Res.	100k Ohm	1/4W	R3248	J02245473	Carbon Film Res.	47k Ohm	1/4W
R3187	J02245101	Carbon Film Res.	100 Ohm	1/4W	R3249	J02245103	Carbon Film Res.	10k Ohm	1/4W
R3188	J02245102	Carbon Film Res.	1k Ohm	1/4W	R3250	J02245472	Carbon Film Res.	4.7k Ohm	1/4W
R3189	J02245221	Carbon Film Res.	220 Ohm	1/4W	R3251	J02245331	Carbon Film Res.	330 Ohm	1/4W
R3190	J02245473	Carbon Film Res.	47k Ohm	1/4W	R3252	J02245681	Carbon Film Res.	680 Ohm	1/4W
R3191	J02245104	Carbon Film Res.	100k Ohm	1/4W	R3253	J02245103	Carbon Film Res.	10k Ohm	1/4W
R3192	J02245103	Carbon Film Res.	10k Ohm	1/4W	R3254	J02245103	Carbon Film Res.	10k Ohm	1/4W
R3193	J02245101	Carbon Film Res.	10k Ohm	1/4W	R3255	J02245103	Carbon Film Res.	10k Ohm	1/4W
R3194	J02245102	Carbon Film Res.	100 Ohm	1/4W	R3256	J02245222	Carbon Film Res.	2.2k Ohm	1/4W
R3195	J02245223	Carbon Film Res.	22k Ohm	1/4W	R3257	J02245103	Carbon Film Res.	10k Ohm	1/4W
R3196	J02245471	Carbon Film Res.	470 Ohm	1/4W	R3258	J02245153	Carbon Film Res.	15k Ohm	1/4W
R3197	J02245101	Carbon Film Res.	100 Ohm	1/4W	R3259	J02245225	Carbon Film Res.	2.2M Ohm	1/4W
R3198	J02245391	Carbon Film Res.	390 Ohm	1/4W	R3260	J02245473	Carbon Film Res.	47k Ohm	1/4W
R3199	J02245102	Carbon Film Res.	1k Ohm	1/4W	R3261	J02245223	Carbon Film Res.	22k Ohm	1/4W
R3200	J02245103	Carbon Film Res.	10k Ohm	1/4W	R3262	J02245332	Carbon Film Res.	3.3k Ohm	1/4W
R3201	J02245101	Carbon Film Res.	100 Ohm	1/4W	R3263	J02245223	Carbon Film Res.	22k Ohm	1/4W
R3202	J02245471	Carbon Film Res.	470 Ohm	1/4W	R3264	J02245332	Carbon Film Res.	3.3k Ohm	1/4W
R3203	J02245104	Carbon Film Res.	100k Ohm	1/4W	R3265	J02245223	Carbon Film Res.	22k Ohm	1/4W
R3204	J02245101	Carbon Film Res.	100 Ohm	1/4W	R3266	J02245332	Carbon Film Res.	3.3k Ohm	1/4W
R3205	J02245471	Carbon Film Res.	470 Ohm	1/4W	R3267	J02245223	Carbon Film Res.	22k Ohm	1/4W
R3206	J02245103	Carbon Film Res.	10k Ohm	1/4W	R3268	J02245332	Carbon Film Res.	3.3k Ohm	1/4W
R3207	J02245223	Carbon Film Res.	22k Ohm	1/4W	R3269	J02245223	Carbon Film Res.	22k Ohm	1/4W
R3208	J02245471	Carbon Film Res.	470 Ohm	1/4W	R3270	J02245332	Carbon Film Res.	3.3k Ohm	1/4W
R3209	J02245680	Carbon Film Res.	680 Ohm	1/4W	R3271	J02245223	Carbon Film Res.	22k Ohm	1/4W
R3210	J02245103	Carbon Film Res.	10k Ohm	1/4W	R3272	J02245332	Carbon Film Res.	3.3k Ohm	1/4W
R3211	J02245473	Carbon Film Res.	47k Ohm	1/4W	R3273	J02245681	Carbon Film Res.	680 Ohm	1/4W
R3212	J02245473	Carbon Film Res.	47k Ohm	1/4W	R3274	J02245471	Carbon Film Res.	470 Ohm	1/4W
R3213	J02245473	Carbon Film Res.	47k Ohm	1/4W	R3275	J02245103	Carbon Film Res.	10k Ohm	1/4W

LOCAL UNIT PARTS LIST

Part No.	Description	QTY	Unit	Value	Material	Part No.	Description	QTY	Unit	Value	Material
R3276	J02245103		1/4W	10k Ohm	Carbon Film Res.	C3054	K13179008				Ceramic Cap.
RB3001	J40900044			7 x 10k Ohm	Block Res.	C3055	K02179017			62pF	Ceramic Cap.
RB3002	J40900053			7 x 47k Ohm	Block Res.	C3056	K02175560			56pF	Ceramic Cap.
RB3003	J40900023			DA-2	Block Res.	C3057	K00172050			5pF	Ceramic Cap.
VR3001	J51745223			22k Ohm	Potentiometer	C3058	K13179008			0.01uF	Ceramic Cap.
VR3002	J51769222			2.2k Ohm	Potentiometer	C3059	K13179008			0.01uF	Ceramic Cap.
C3001	K13179008		50V	0.01uF	Ceramic Cap.	C3060	K00179001			0.5pF	Ceramic Cap.
C3002	K13179008		50V	0.01uF	Ceramic Cap.	C3061	K12171102			0.001uF	Ceramic Cap.
C3003	K00175150		50V	15pF	Ceramic Cap.	C3062	K13179008			0.01uF	Ceramic Cap.
C3004	K00175470		50V	47pF	Ceramic Cap.	C3063	K13179008			0.01uF	Ceramic Cap.
C3005	K13179008		50V	0.01uF	Ceramic Cap.	C3064	K12171102			0.001uF	Ceramic Cap.
C3006	K13179008		50V	0.01uF	Ceramic Cap.	C3065	K12171102			0.001uF	Ceramic Cap.
C3007	K13179008		50V	0.01uF	Ceramic Cap.	C3066	K12171102			0.001uF	Ceramic Cap.
C3008	K13179008		50V	0.01uF	Ceramic Cap.	C3067	K13179008			0.01uF	Ceramic Cap.
C3009	K13179008		50V	0.01uF	Ceramic Cap.	C3068	K13179008			0.01uF	Ceramic Cap.
C3010	K02179009		50V	0.01uF	Ceramic Cap.	C3069	K13179008			0.01uF	Ceramic Cap.
C3011	K02179009		50V	22pF	Ceramic Cap.	C3070	K00175181			180pF	Ceramic Cap.
C3012	K02175390		50V	39pF	Ceramic Cap.	C3071	K00175820			82pF	Ceramic Cap.
C3013	K02179009		50V	22pF	Ceramic Cap.	C3072	K00179022			360pF	Ceramic Cap.
C3014	K13179008		50V	0.01uF	Ceramic Cap.	C3073	K00179009			43pF	Ceramic Cap.
C3015	K13179008		50V	0.01uF	Ceramic Cap.	C3074	K00175391			390pF	Ceramic Cap.
C3016	K13179008		50V	0.01uF	Ceramic Cap.	C3075	K00175120			12pF	Ceramic Cap.
C3017	K13179008		50V	0.01uF	Ceramic Cap.	C3076	K00179020			240pF	Ceramic Cap.
C3018	K13179008		50V	0.01uF	Ceramic Cap.	C3077	K13179008			0.01uF	Ceramic Cap.
C3019	K13179008		50V	0.01uF	Ceramic Cap.	C3078	K13179008			0.01uF	Ceramic Cap.
C3020	K02173100		50V	0.01uF	Ceramic Cap.	C3079	K13179008			0.01uF	Ceramic Cap.
C3021	K13179008		50V	10pF	Ceramic Cap.	C3080	K12171102			0.001uF	Ceramic Cap.
C3022	K13179008		50V	0.01uF	Ceramic Cap.	C3081	K40129004			10uF	Al Electro Cap.
C3023	K02179027		50V	0.01uF	Ceramic Cap.	C3082	K40129008			33uF	Al Electro Cap.
C3024	K02179027		50V	270pF	Ceramic Cap.	C3083	K13179008			0.01uF	Ceramic Cap.
C3025	K13179008		50V	270pF	Ceramic Cap.	C3084	K19149005			0.0022uF	Ceramic Cap.
C3026	K00175220		50V	22pF	Ceramic Cap.	C3085	K05173080			8pF	Ceramic Cap.
C3027	K13179008		50V	0.01uF	Ceramic Cap.	C3086	K06175120			12pF	Ceramic Cap.
C3028	K00173060		50V	6pF	Ceramic Cap.	C3087	K05173100			10pF	Ceramic Cap.
C3029	K00172040		50V	4pF	Ceramic Cap.	C3088	K02175120			12pF	Ceramic Cap.
C3030	K13179008		50V	0.01uF	Ceramic Cap.	C3089	K12171102			0.001uF	Ceramic Cap.
C3031	K13179008		50V	0.01uF	Ceramic Cap.	C3090	K40129008			33uF	Al Electro Cap.
C3032	K00172050		50V	5pF	Ceramic Cap.	C3091	K02172059			0.5pF	Ceramic Cap.
C3033	K00172050		50V	5pF	Ceramic Cap.	C3092	K12171102			0.001uF	Ceramic Cap.
C3034	K13179008		50V	0.01uF	Ceramic Cap.	C3093	K12171102			0.001uF	Ceramic Cap.
C3035	K13179008		50V	0.01uF	Ceramic Cap.	C3094	K13179008			0.01uF	Ceramic Cap.
C3036	K13179008		50V	0.01uF	Ceramic Cap.	C3095	K10176101			100pF	Ceramic Cap.
C3037	K13179008		50V	0.01uF	Ceramic Cap.	C3096	K10176101			100pF	Ceramic Cap.
C3038	K13179008		50V	0.01uF	Ceramic Cap.	C3097	K10176101			100pF	Ceramic Cap.
C3039	K13179008		50V	0.01uF	Ceramic Cap.	C3098	K19149013			0.01uF	Ceramic Cap.
C3040	K13179008		50V	0.01uF	Ceramic Cap.	C3099	K40179013			0.01uF	Ceramic Cap.
C3041	K00173080		50V	8pF	Ceramic Cap.	C3100	K00173080			1uF	Al Electro Cap.
C3042	K00175180		50V	18pF	Ceramic Cap.	C3101	K40129008			8pF	Ceramic Cap.
C3043	K13179008		50V	0.01uF	Ceramic Cap.	C3102	K19149017			33uF	Al Electro Cap.
C3044	K13179008		50V	0.01uF	Ceramic Cap.	C3103	K00175560			0.022uF	Ceramic Cap.
C3045	K02175150		50V	15pF	Ceramic Cap.	C3104	K00175121			56pF	Ceramic Cap.
C3046	K13179008		50V	0.01uF	Ceramic Cap.	C3105	K00175560			56pF	Ceramic Cap.
C3047	K40179013		50V	1uF	Al Electro Cap.	C3106	K13179008			0.01uF	Ceramic Cap.
C3048	K06172040		50V	4pF	Ceramic Cap.	C3107	K13179008			0.01uF	Ceramic Cap.
C3049	K13179008		50V	0.01uF	Ceramic Cap.	C3108	K13179008			0.01uF	Ceramic Cap.
C3050	K13179008		50V	0.01uF	Ceramic Cap.	C3109	K00173080			8pF	Ceramic Cap.
C3051	K40179011		50V	3.3uF	Al Electro Cap.	C3110	K00173080			33uF	Al Electro Cap.
C3052	K06175101		50V	100pF	Ceramic Cap.	C3111	K40129008			0.01uF	Ceramic Cap.
C3053	K06175101		50V	100pF	Ceramic Cap.	C3112	K13179008			0.01uF	Ceramic Cap.

LOCAL UNIT PARTS LIST

C3116	K19149013	Ceramic Cap.	0.01uF	25V	Sr	C3179	K00175330	Ceramic Cap.	33pF	50V	SL
C3117	K40179013	Al Electro Cap.	1uF	50V	Sr	C3180	K13179008	Ceramic Cap.	0.01uF	50V	F
C3118	K19149021	Ceramic Cap.	0.047uF	25V	Sr	C3181	K13179008	Ceramic Cap.	0.01uF	50V	F
C3120	K19149009	Ceramic Cap.	0.0047uF	25V	Sr	C3182	K13179008	Ceramic Cap.	0.01uF	50V	F
C3121	K40129008	Al Electro Cap.	33uF	16V	F	C3183	K13179008	Ceramic Cap.	0.01uF	50V	F
C3122	K13179008	Ceramic Cap.	0.01uF	50V	F	C3184	K12171102	Ceramic Cap.	0.001uF	50V	E
C3123	K06175220	Ceramic Cap.	22pF	50V	UJ	C3185	K13179008	Ceramic Cap.	0.01uF	50V	F
C3124	K06175220	Ceramic Cap.	22pF	50V	UJ	C3186	K13179008	Ceramic Cap.	0.01uF	50V	F
C3125	K05175120	Ceramic Cap.	12pF	50V	RH	C3187	K13179008	Ceramic Cap.	0.01uF	50V	F
C3126	K05175470	Ceramic Cap.	47pF	50V	RH	C3188	K00173080	Ceramic Cap.	8pF	50V	F
C3127	K40129008	Al Electro Cap.	33uF	16V	F	C3189	K00172030	Ceramic Cap.	3pF	50V	CH
C3128	K13179008	Ceramic Cap.	0.01uF	50V	F	C3190	K02179006	Ceramic Cap.	24pF	50V	SL
C3129	K02179001	Ceramic Cap.	1pF	50V	CK	C3191	K00173080	Ceramic Cap.	8pF	50V	SL
C3130	K02172059	Ceramic Cap.	0.5pF	50V	CK	C3192	K00175220	Ceramic Cap.	22pF	50V	SL
C3131	K13179008	Ceramic Cap.	0.01uF	50V	F	C3193	K00173100	Ceramic Cap.	10pF	50V	SL
C3132	K13179008	Ceramic Cap.	0.01uF	50V	F	C3194	K00175270	Ceramic Cap.	27pF	50V	SL
C3133	K13179008	Ceramic Cap.	0.01uF	50V	F	C3195	K00172050	Ceramic Cap.	5pF	50V	SL
C3134	K13179008	Ceramic Cap.	0.01uF	50V	F	C3196	K00175270	Ceramic Cap.	27pF	50V	SL
C3135	K13179008	Ceramic Cap.	0.01uF	50V	F	C3197	K00179001	Ceramic Cap.	0.5pF	50V	SL
C3136	K13179008	Ceramic Cap.	0.01uF	50V	F	C3198	K00175120	Ceramic Cap.	12pF	50V	SL
C3137	K13179008	Ceramic Cap.	0.01uF	50V	F	C3199	K13179008	Ceramic Cap.	0.01uF	50V	F
C3138	K13179008	Ceramic Cap.	0.01uF	50V	F	C3200	K13179008	Ceramic Cap.	0.01uF	50V	F
C3139	K13179008	Ceramic Cap.	0.01uF	50V	F	C3201	K13179008	Ceramic Cap.	180pF	50V	F
C3140	K40129004	Al Electro Cap.	10uF	16V	F	C3202	K10176181	Ceramic Cap.	0.01uF	50V	F
C3141	K13179008	Ceramic Cap.	0.01uF	50V	F	C3203	K13179008	Ceramic Cap.	0.01uF	50V	B
C3142	K00179015	Ceramic Cap.	110pF	50V	SL	C3204	K13179008	Ceramic Cap.	0.01uF	50V	F
C3143	K00179010	Ceramic Cap.	51pF	50V	SL	C3205	K13179008	Ceramic Cap.	0.01uF	50V	F
C3144	K00175221	Ceramic Cap.	220pF	50V	SL	C3206	K13179008	Ceramic Cap.	0.01uF	50V	F
C3145	K00179006	Ceramic Cap.	24pF	50V	SL	C3207	K40129008	Al Electro Cap.	33uF	16V	B
C3146	K00179020	Ceramic Cap.	240pF	50V	SL	C3208	K10176101	Ceramic Cap.	100pF	50V	B
C3147	K00172050	Ceramic Cap.	5pF	50V	SL	C3209	K10176101	Ceramic Cap.	100pF	50V	B
C3148	K00175151	Ceramic Cap.	150pF	50V	SL	C3210	K10176101	Ceramic Cap.	1uF	50V	B
C3149	K13179008	Ceramic Cap.	0.01uF	50V	F	C3211	K40179013	Al Electro Cap.	0.47uF	20V	
C3150	K13179008	Ceramic Cap.	0.01uF	50V	F	C3212	K54200012	Film Cap.	33uF	16V	
C3151	K00173060	Ceramic Cap.	6pF	50V	SL	C3213	K40129008	Al Electro Cap.	0.01uF	25V	Sr
C3152	K00173080	Ceramic Cap.	8pF	50V	SL	C3214	K19149013	Ceramic Cap.	0.001uF	50V	E
C3153	K13179008	Ceramic Cap.	0.01uF	50V	F	C3215	K12171102	Ceramic Cap.	0.001uF	50V	UJ
C3154	K13179008	Ceramic Cap.	0.01uF	50V	F	C3216	K06175330	Ceramic Cap.	33pF	50V	UJ
C3155	K00172020	Ceramic Cap.	2pF	50V	SL	C3217	K06175180	Ceramic Cap.	18pF	50V	UJ
C3156	K00172020	Ceramic Cap.	2pF	50V	SL	C3218	K06175150	Ceramic Cap.	15pF	50V	UJ
C3157	K00175220	Ceramic Cap.	22pF	50V	SL	C3219	K06175220	Ceramic Cap.	22pF	50V	UJ
C3158	K13179008	Ceramic Cap.	0.01uF	50V	F	C3220	K12171102	Ceramic Cap.	0.001uF	50V	E
C3159	K13179008	Ceramic Cap.	0.01uF	50V	F	C3221	K40149001	Al Electro Cap.	4.7uF	25V	UJ
C3160	K13179008	Ceramic Cap.	0.01uF	50V	F	C3222	K06179006	Ceramic Cap.	30pF	50V	UJ
C3161	K12171102	Ceramic Cap.	0.001uF	50V	E	C3223	K06175180	Ceramic Cap.	18pF	50V	UJ
C3162	K12171102	Ceramic Cap.	0.001uF	50V	E	C3224	K06175150	Ceramic Cap.	15pF	50V	UJ
C3163	K00173080	Ceramic Cap.	8pF	50V	E	C3225	K06175220	Ceramic Cap.	22pF	50V	UJ
C3164	K00172020	Ceramic Cap.	2pF	50V	SL	C3226	K12171102	Ceramic Cap.	0.001uF	50V	E
C3165	K02173070	Ceramic Cap.	7pF	50V	CH	C3227	K40149001	Al Electro Cap.	4.7uF	25V	UJ
C3166	K02179009	Ceramic Cap.	22pF	50V	CH	C3228	K06175680	Ceramic Cap.	68pF	50V	UJ
C3167	K02175680	Ceramic Cap.	68pF	50V	CH	C3229	K06175150	Ceramic Cap.	15pF	50V	UJ
C3168	K12171102	Ceramic Cap.	0.001uF	50V	E	C3230	K06175120	Ceramic Cap.	12pF	50V	UJ
C3169	K00172010	Ceramic Cap.	1pF	50V	SL	C3231	K06175180	Ceramic Cap.	18pF	50V	UJ
C3170	K00172020	Ceramic Cap.	2pF	50V	SL	C3232	K12171102	Ceramic Cap.	0.001uF	50V	E
C3171	K12171102	Ceramic Cap.	0.001uF	50V	E	C3233	K40149001	Al Electro Cap.	4.7uF	25V	UJ
C3172	K12171102	Ceramic Cap.	0.001uF	50V	E	C3234	K06175470	Ceramic Cap.	47pF	50V	UJ
C3173	K13179008	Ceramic Cap.	0.01uF	50V	F	C3235	K02175150	Ceramic Cap.	15pF	50V	CH
C3174	K13179008	Ceramic Cap.	0.01uF	50V	F	C3236	K06175120	Ceramic Cap.	12pF	50V	UJ
C3175	K13179008	Ceramic Cap.	0.01uF	50V	F	C3237	K06173100	Ceramic Cap.	10pF	50V	UJ
C3176	K12171102	Ceramic Cap.	0.001uF	50V	E	C3238	K12171102	Ceramic Cap.	0.001uF	50V	E
C3177	K00172010	Ceramic Cap.	1pF	50V	SL	C3239	K40149001	Al Electro Cap.	4.7uF	25V	E
C3178	K02172010	Ceramic Cap.	1pF	50V	SL	C3240	K06175470	Ceramic Cap.	47pF	50V	UJ

LOCAL UNIT PARTS LIST

C3241	K05175150	Ceramic Cap.	50V	RH	L3006	L1190039	RFC
C3242	K06175120	Ceramic Cap.	50V	UJ	L3007	L1190221	RFC
C3243	K02173080	Ceramic Cap.	50V	CH	L3008	L1190221	RFC
C3244	K12171102	Ceramic Cap.	50V	E	L3009	L1190221	RFC
C3245	K40149001	Al. Electro Cap.	25V	E	L3010	L1190020	RFC
C3246	K12171102	Ceramic Cap.	50V	CH	L3011	L0021206B	Coil
C3247	K02173080	Ceramic Cap.	50V	CH	L3012	L1190020	RFC
C3249	K13179008	Ceramic Cap.	50V	F	L3013	L1190020	RFC
C3250	K12171102	Ceramic Cap.	50V	E	L3014	L1190030	RFC
C3252	K00175270	Ceramic Cap.	50V	E	L3015	L1190031	RFC
C3253	K00175560	Ceramic Cap.	50V	SL	L3016	L1190031	RFC
C3254	K00175270	Ceramic Cap.	50V	SL	L3017	L1190220	RFC
C3255	K02179001	Ceramic Cap.	50V	SL	L3018	L1190220	RFC
C3256	K02172030	Ceramic Cap.	50V	CK	L3019	L1190004	RFC
C3257	K12171102	Ceramic Cap.	50V	E	L3020	L1190014	RFC
C3258	K12171102	Ceramic Cap.	50V	E	L3021	L1190014	RFC
C3259	K12171102	Ceramic Cap.	50V	E	L3022	L1190005	RFC
C3260	K12171102	Ceramic Cap.	50V	E	L3023	L1190220	RFC
C3261	K00172050	Ceramic Cap.	50V	SL	L3024	L1190220	RFC
C3262	K13179008	Ceramic Cap.	50V	F	L3025	L1190025	RFC
C3263	K13179008	Ceramic Cap.	50V	F	L3026	L1190029	RFC
C3264	K00172020	Ceramic Cap.	50V	F	L3027	L1190029	RFC
C3265	K13179008	Ceramic Cap.	50V	SL	L3028	L1190008	RFC
C3266	K40129004	Al. Electro Cap.	50V	F	L3029	L1190220	RFC
C3267	K13179008	Ceramic Cap.	16V	F	L3030	L1190220	RFC
C3268	K13179008	Ceramic Cap.	50V	F	L3031	L1190005	RFC
C3269	K19149025	Ceramic Cap.	25V	F	L3032	L1190029	RFC
C3270	K40179011	Al. Electro Cap.	50V	Sr	L3033	L1190029	RFC
C3271	K40179009	Al. Electro Cap.	50V	SL	L3034	L1190029	RFC
C3272	K00175680	Ceramic Cap.	50V	SL	L3035	L1190029	RFC
C3273	K00175680	Ceramic Cap.	50V	SL	L3036	L1190029	RFC
C3274	K13179008	Ceramic Cap.	50V	F	L3037	L1190218	RFC
C3275	K40179013	Al. Electro Cap.	50V	F	L3038	L1190008	RFC
C3276	K19149021	Ceramic Cap.	25V	Sr	L3039	L0021410	Coil
C3277	K10176101	Ceramic Cap.	25V	B	L3040	L0021410	Coil
C3278	K10176151	Ceramic Cap.	50V	B	L3041	L1190222	RFC
C3279	K19149025	Ceramic Cap.	25V	Sr	L3042	L1190149	RFC
C3280	K40129008	Al. Electro Cap.	16V	SL	T3001	L0021609	Coil
C3281	K40129004	Al. Electro Cap.	16V	SL	T3002	L0021609	Coil
C3282	K13179008	Ceramic Cap.	50V	F	T3003	L0021609	Coil
C3283	K40179013	Al. Electro Cap.	50V	F	T3004	L0020332A	Coil
C3284	K40129004	Al. Electro Cap.	16V	F	T3005	L0021199	Coil
C3285	K13179008	Ceramic Cap.	50V	F	T3006	L0021199	Coil
C3286	K12171102	Ceramic Cap.	50V	E	T3007	L0020904	Coil
CB3001	K80000007	Block Cap.	8 X 0.01uF		T3008	L0021557	Coil
CB3002	K80000002	Block Cap.	6 X 0.01uF		T3009	L0021557	Coil
TC3001	K91000086	Trimmer Cap.	20pF	VCT51E117	T3010	L0020909	Coil
TC3002	K91000086	Trimmer Cap.	20pF	VCT51E117	T3011	L0020909	Coil
TC3003	K91000086	Trimmer Cap.	20pF	VCT51E117	T3012	L0020909	Coil
TC3004	K91000093	Trimmer Cap.	30pF	VCT51F	T3013	L0020909	Coil
TC3005	K91000086	Trimmer Cap.	20pF	VCT51E117	T3014	L0021554	Coil
TC3006	K91000086	Trimmer Cap.	20pF	VCT51E117	T3015	L0021912	Coil
TC3007	K91000086	Trimmer Cap.	20pF	VCT51E117	T3016	L0021912	Coil
L3001	L1190039	RFC			T3017	L0021912	Coil
L3002	L1190039	RFC			T3018	L0021912	Coil
L3003	L1190039	RFC			T3019	L0021234	Coil
L3004	L1190039	RFC			T3020	L0021234	Coil
L3005	L1190039	RFC			T3021	L0021234	Coil
					T3022	L0021234	Coil
					T3023	L0021555	Coil

LOCAL UNIT PARTS LIST

T3024	L0021553	Coil		
T3025	L0021553	Coil		
T3026	L0021553	Coil		
T3027	L0021553	Coil		
T3028	L0021559	Coil		
T3029	L0021559	Coil		
T3030	L0021399	Coil		
T3031	L0021400	Coil		
T3032	L0021401	Coil		
T3033	L0020783	Coil		
BZ3001	M4290001	Buzzer		EFBRE-25D02
S3001	N6090064	Switch		SS912
S3002	N4090012	Switch		SPJ-22-A01
S3003	N4090012	Switch		SPJ-22-A01
S3004	N4090012	Switch		SPJ-22-A01
S3005	N6090064	Switch		SS912
J3001	P1090255	Connector		TMP-JA
J3002	P1090255	Connector		TMP-JA
J3003	P1090255	Connector		TMP-JA
J3004	P1090255	Connector		TMP-JA
J3005	P1090255	Connector		TMP-JA
J3006	P1090296	Connector		S-Q3097-02
J3007	P1090354	Connector		S-Q3097-04
J3008	P0090191	Connector		B02B-XH-A
J3009	P0090191	Connector		B02B-XH-A
J3010	P0090192	Connector		B02B-XH-A
J3011	P0090196	Connector		B03B-XH-A
J3012	P0090196	Connector		B02B-XH-A
J3013	P0090193	Connector		B07B-XH-A
J3014	P0090194	Connector		B04B-XH-A
J3015	P0090202	Connector		B05B-XH-A
J3016	P0090193	Connector		B13B-XH-A
J3017	P0090194	Connector		B04B-XH-A
J3018	P0090194	Connector		B05B-XH-A
J3019	P0090200	Connector		B05B-XH-A
J3020	P0090191	Connector		B11B-XH-A
J3021	P0090191	Connector		B02B-XH-A
J3022	P0090192	Connector		B03B-XH-A
J3023	P0090193	Connector		B04B-XH-A
J3024	P0090197	Connector		B04B-XH-A
J3025	P0090191	Connector		B08B-XH-A
J3026	P0090197	Connector		B02B-XH-A
J3027	P1090423	Connector		B08B-XH-A
J3028	P1090521	Connector		TCS4460-01-111
J3029	P0090192	Connector		TCS4490-01-111
J3030	P0090191	Connector		B03B-XH-A
J3031	P1090210	Connector		B02B-XH-A
J3032	P1090210	Connector		TMP-JV
J3033	P1090210	Connector		TMP-JV
J3034	P1090210	Connector		TMP-JV
	Q5000050	Terminal Posts		
	Q5000082	Terminal Posts		
BA3001	Q9000309	Lithium Battery		2L76-T2 (CR-1/3N)

FEX-767-2 PLL UNIT PARTS LAYOUT

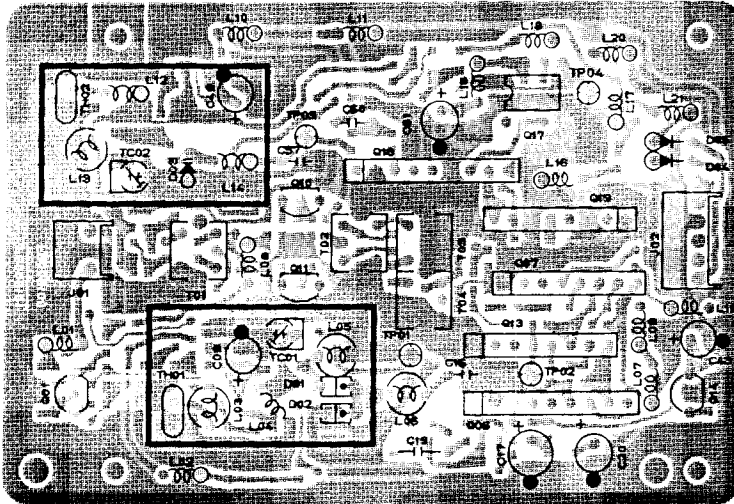

(Obverse view of "component" side)

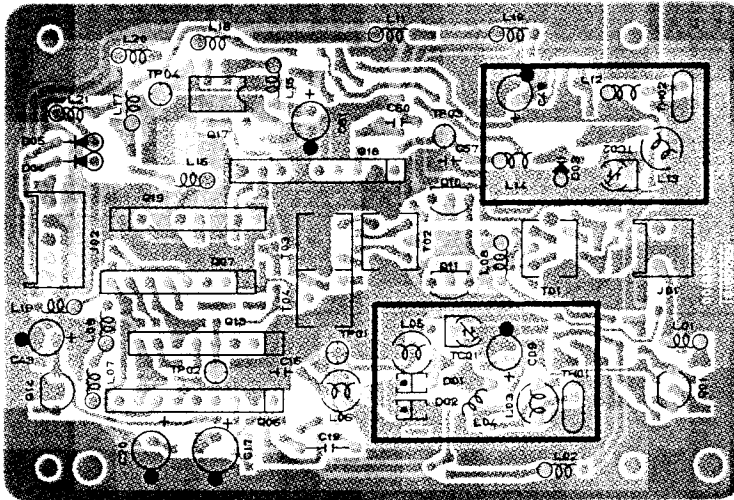

(Reverse view of "component" side)

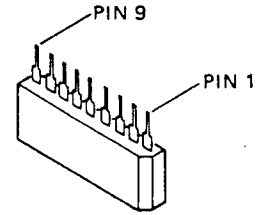

TC5081AP (Q2006,2018)

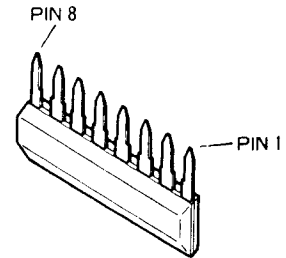

M54455L (Q2019)
M54459L (Q2007,2013)

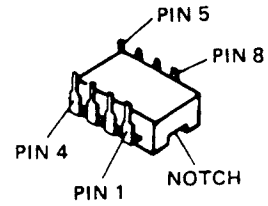

MC12017P (Q2017)

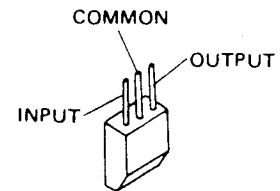

μ PC78L05J (Q2014)

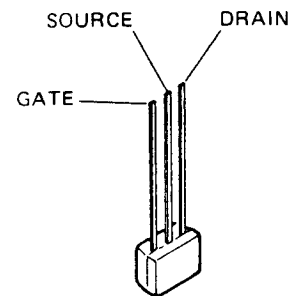

2SK241Y (Q2010,2011)

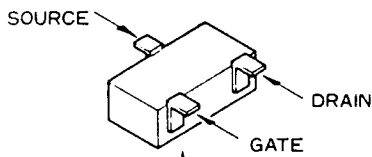

Marked Surface

2SK210GR (YG)
(Q2002,2003,2008,
2015,2016)

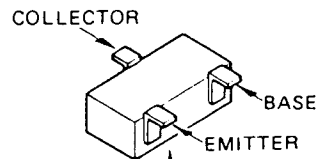

Marked Surface

2SC2620 (QB)
(Q2009,2012)
2SC2712GR (LG)
(Q2004,2005)

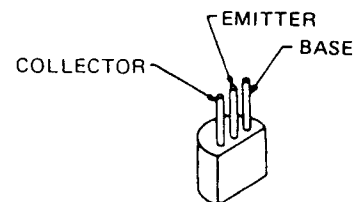

2SC2026 (Q2001)

FEX-767-2 PLL UNIT PARTS LAYOUT

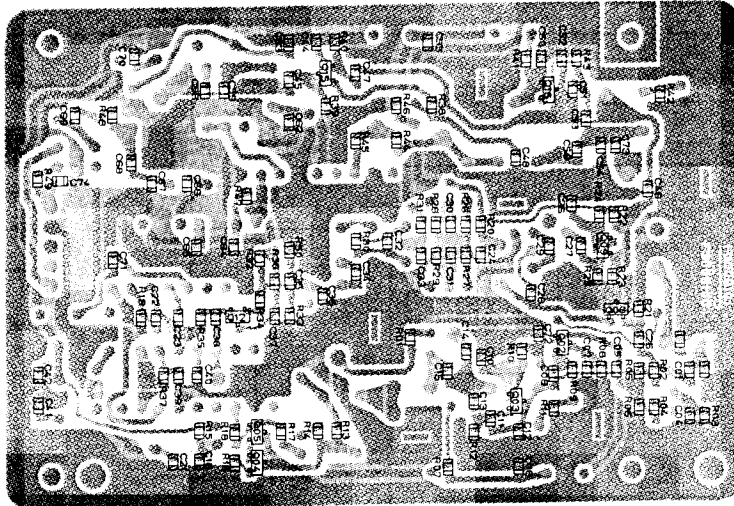

(Obverse view of "chip" side)

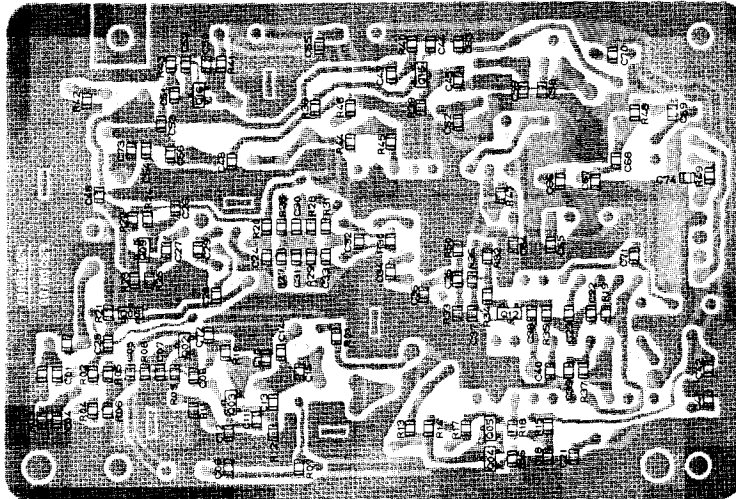

(Reverse view of "chip" side)

FEX-767-2 PLL UNIT VOLTAGE CHART (DC VOLT)

	E (S)	C (D)	B (G)	REMARKS
Q2001	5.05	1.11	1.84	
Q2002	0.25	8.52	0	
Q2003	0.82	8.29	0	
Q2004	0	5.03	0.10	
Q2005	0.21	5.03	0.10	
Q2008	0	8.30	-0.30	
Q2009	2.47	7.96	3.24	
Q2010	0.99	8.54	0	
Q2011	1.00	8.50	0	
Q2012	2.48	8.02	3.26	
Q2015	2.12	8.63	0	
Q2016	0.89	8.16	0	

FEX-767-2 PLL UNIT CIRCUIT DIAGRAM

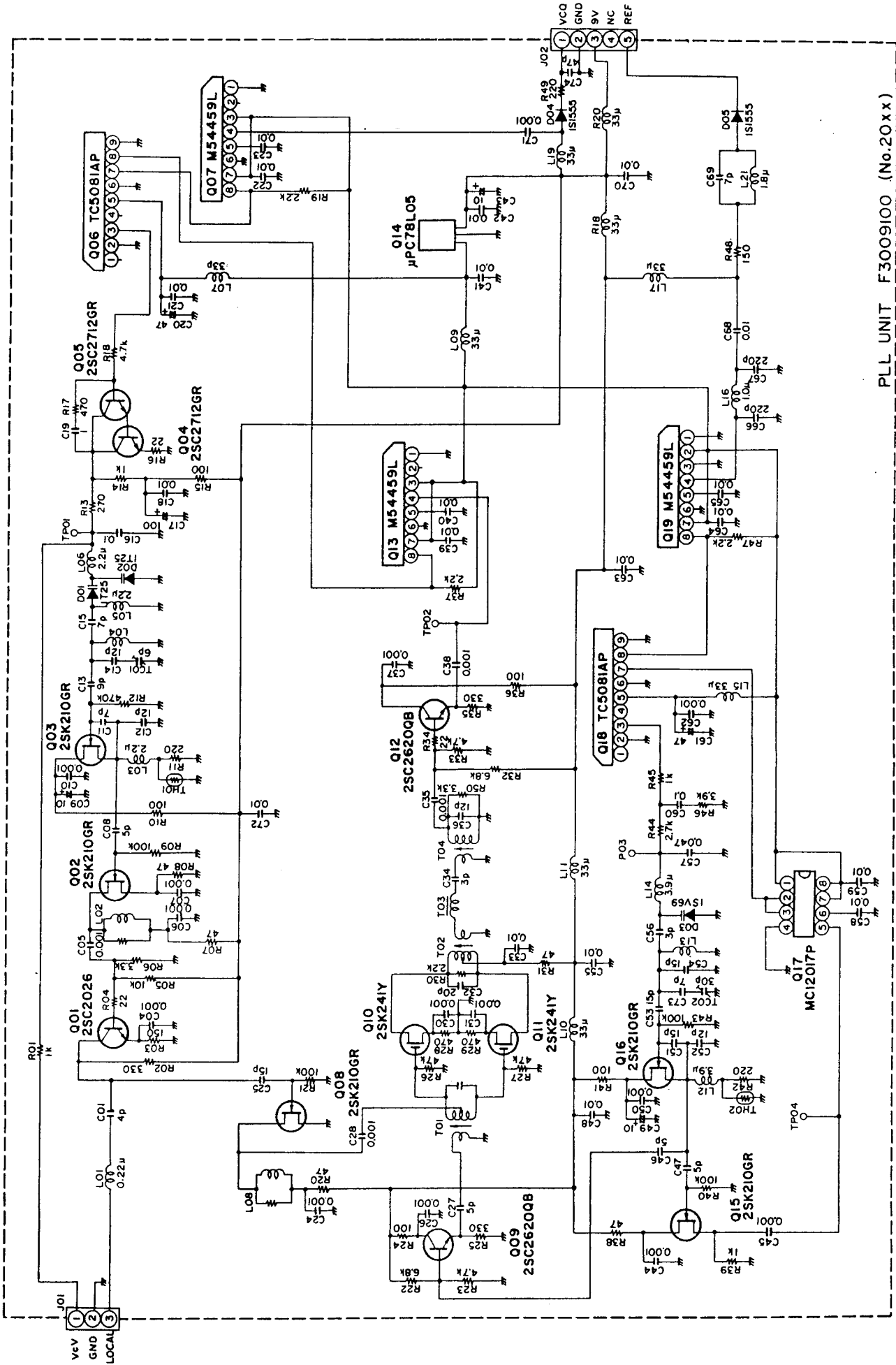

PLL UNIT F3009100 (No.20xx)

RESISTOR VALUES ARE IN Ω, 1/10W;
 CAPACITOR VALUES ARE IN µF, 50V;
 ELECTROLYTIC CAPACITOR VALUES ARE
 AND INDUCTOR VALUES ARE IN H;
 UNLESS OTHERWISE NOTED.

FEX-767-2 PLL UNIT ALIGNMENT

(1) Sub Loop VCV (Varactor Control Voltage)

Connect the high-impedance DC voltmeter to TP2003, and the frequency counter to TP2004. Adjust TC2002 for $2.0 \pm 0.1V$, and confirm $120 \text{ MHz} \pm 1 \text{ kHz}$ on the counter.

(2) Main Loop VCV

Tune to the high edge of the band and connect the high impedance DC voltmeter to TP2001. Adjust TC2001 for $8.2 \pm 0.1V$ on the meter. Retune to the low edge of the band and confirm 1 to 2V.

(3) PLL Output Level

Connect the RF millivoltmeter to TP2002. Tune to the center of the band and adjust T2001 for maximum RF. Then retune as indicated below, adjusting each transformer for maximum RF above the levels indicated.

<u>Frequency</u>	<u>Transformer</u>	<u>Min. Level</u>
Low Edge	T2003	100 mVrms
Band Center	T2002	100 mVrms
High Edge	T2004	80 mVrms

Repeat the adjustments at each frequency several times.

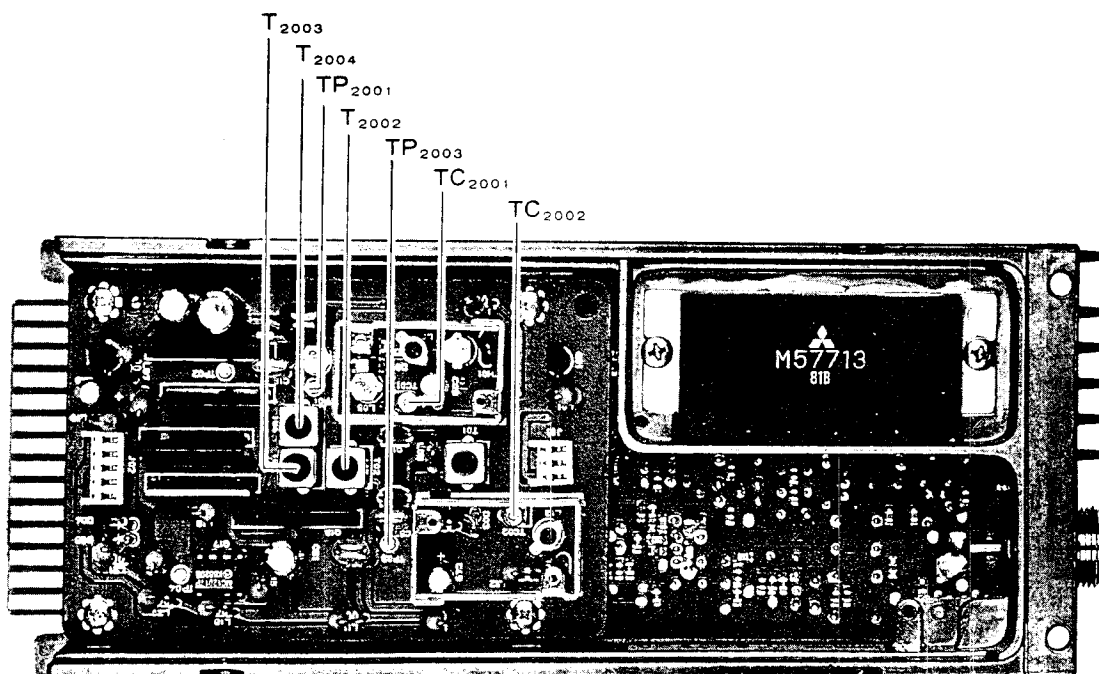

FEX-767-2 PLL UNIT ALIGNMENT POINTS

FEX-767-2 PLL UNIT PARTS LIST

Part No.	Part Name	QTY	Part No.	Part Name	QTY	Part No.	Part Name	QTY	Part No.	Part Name	QTY
Q 2001	G3320260	1	R 2026	J24205473	1	R 2026	J24205473	1	RES.	Chip	1/10W
Q 2002	G3802107G	1	R 2027	J24205473	1	R 2027	J24205473	1	RES.	Chip	1/10W
Q 2003	G3802107G	1	R 2028	J24205471	1	R 2028	J24205471	1	RES.	Chip	1/10W
Q 2004	G3327127G	1	R 2029	J24205471	1	R 2029	J24205471	1	RES.	Chip	1/10W
Q 2005	G3327127G	1	R 2030	J24205222	1	R 2030	J24205222	1	RES.	Chip	1/10W
Q 2006	G1090473	1	R 2031	J24205470	1	R 2031	J24205470	1	RES.	Chip	1/10W
Q 2007	G1090838	1	R 2032	J24205682	1	R 2032	J24205682	1	RES.	Chip	1/10W
Q 2008	G3802107G	1	R 2033	J24205472	1	R 2033	J24205472	1	RES.	Chip	1/10W
Q 2009	G3326207B	1	R 2034	J24205220	1	R 2034	J24205220	1	RES.	Chip	1/10W
Q 2010	G3802410Y	1	R 2035	J24205331	1	R 2035	J24205331	1	RES.	Chip	1/10W
Q 2011	G3802410Y	1	R 2036	J24205101	1	R 2036	J24205101	1	RES.	Chip	1/10W
Q 2012	G3326207B	1	R 2037	J24205222	1	R 2037	J24205222	1	RES.	Chip	1/10W
Q 2013	G1090838	1	R 2038	J24205470	1	R 2038	J24205470	1	RES.	Chip	1/10W
Q 2014	G1090848	1	R 2039	J24205102	1	R 2039	J24205102	1	RES.	Chip	1/10W
Q 2015	G3802107G	1	R 2040	J24205104	1	R 2040	J24205104	1	RES.	Chip	1/10W
Q 2016	G3802107G	1	R 2041	J24205101	1	R 2041	J24205101	1	RES.	Chip	1/10W
Q 2017	G1090725	1	R 2042	J24205221	1	R 2042	J24205221	1	RES.	Chip	1/10W
Q 2018	G1090473	1	R 2043	J24205104	1	R 2043	J24205104	1	RES.	Chip	1/10W
Q 2019	G1090697	1	R 2044	J24205272	1	R 2044	J24205272	1	RES.	Chip	1/10W
D 2001	G2090107	1	R 2045	J24205102	1	R 2045	J24205102	1	RES.	Chip	1/10W
D 2002	G2090107	1	R 2046	J24205392	1	R 2046	J24205392	1	RES.	Chip	1/10W
D 2003	G2090109	1	R 2047	J24205222	1	R 2047	J24205222	1	RES.	Chip	1/10W
D 2004	G2015550	1	R 2048	J24205151	1	R 2048	J24205151	1	RES.	Chip	1/10W
D 2005	G2015550	1	R 2049	J24205221	1	R 2049	J24205221	1	RES.	Chip	1/10W
TH 2001	G9090008	1	R 2050	J24205332	1	R 2050	J24205332	1	RES.	Chip	1/10W
TH 2002	G9090008	1	C 2001	K22170205	1	C 2001	K22170205	1	CAP.	Chip	50V
R 2001	J24205102	1	C 2004	K22170805	1	C 2004	K22170805	1	CAP.	Chip	50V
R 2002	J24205331	1	C 2005	K22170805	1	C 2005	K22170805	1	CAP.	Chip	50V
R 2003	J24205151	1	C 2006	K22170805	1	C 2006	K22170805	1	CAP.	Chip	50V
R 2004	J24205220	1	C 2007	K22170805	1	C 2007	K22170805	1	CAP.	Chip	50V
R 2005	J24205103	1	C 2008	K22170206	1	C 2008	K22170206	1	CAP.	Chip	50V
R 2006	J24205332	1	C 2009	K40129004	1	C 2009	K40129004	1	AL.Electro	CAP.	16V
R 2007	J24205470	1	C 2010	K22170805	1	C 2010	K22170805	1	CAP.	Chip	50V
R 2008	J24205470	1	C 2011	K22170208	1	C 2011	K22170208	1	CAP.	Chip	50V
R 2009	J24205104	1	C 2012	K22170213	1	C 2012	K22170213	1	CAP.	Chip	50V
R 2010	J24205101	1	C 2013	K22170210	1	C 2013	K22170210	1	CAP.	Chip	50V
R 2011	J24205221	1	C 2014	K22170213	1	C 2014	K22170213	1	CAP.	Chip	50V
R 2012	J24205474	1	C 2015	K22170208	1	C 2015	K22170208	1	CAP.	Chip	50V
R 2013	J24205271	1	C 2016	K50170017	1	C 2016	K50170017	1	MYLAR CAP.	CAP.	50V
R 2014	J24205102	1	C 2017	K40129007	1	C 2017	K40129007	1	AL.Electro	CAP.	16V
R 2015	J24205101	1	C 2018	K22170817	1	C 2018	K22170817	1	CAP.	Chip	50V
R 2016	J24205220	1	C 2019	K52170002	1	C 2019	K52170002	1	MYLAR CAP.	CAP.	50V
R 2017	J24205471	1	C 2020	K40129002	1	C 2020	K40129002	1	AL.Electro	CAP.	16V
R 2018	J24205472	1	C 2021	K22170817	1	C 2021	K22170817	1	CAP.	Chip	50V
R 2019	J24205222	1	C 2022	K22170817	1	C 2022	K22170817	1	CAP.	Chip	50V
R 2020	J24205470	1	C 2023	K22170817	1	C 2023	K22170817	1	CAP.	Chip	50V
R 2021	J24205104	1	C 2024	K22170805	1	C 2024	K22170805	1	CAP.	Chip	50V
R 2022	J24205682	1	C 2025	K22170215	1	C 2025	K22170215	1	CAP.	Chip	50V
R 2023	J24205472	1	C 2026	K22170805	1	C 2026	K22170805	1	CAP.	Chip	50V
R 2024	J24205101	1	C 2027	K22170206	1	C 2027	K22170206	1	CAP.	Chip	50V
R 2025	J24205331	1	C 2028	K22170805	1	C 2028	K22170805	1	CAP.	Chip	50V
			C 2029	K22170209	1	C 2029	K22170209	1	CAP.	Chip	50V
			C 2030	K22170805	1	C 2030	K22170805	1	CAP.	Chip	50V
			C 2031	K22170805	1	C 2031	K22170805	1	CAP.	Chip	50V
			C 2032	K22170219	1	C 2032	K22170219	1	CAP.	Chip	50V
			C 2033	K22170817	1	C 2033	K22170817	1	CAP.	Chip	50V
			C 2034	K22170204	1	C 2034	K22170204	1	CAP.	Chip	50V
			C 2035	K22170805	1	C 2035	K22170805	1	CAP.	Chip	50V
			C 2036	K22170219	1	C 2036	K22170219	1	CAP.	Chip	50V
			C 2037	K22170805	1	C 2037	K22170805	1	CAP.	Chip	50V
			C 2038	K22170805	1	C 2038	K22170805	1	CAP.	Chip	50V
			C 2039	K22170817	1	C 2039	K22170817	1	CAP.	Chip	50V

FEX-767-2 PLL UNIT PARTS LIST

T 2003	L0020963	Coil	132MHz
T 2004	L0021646	Coil	
J 2001	P1090425	Connector	5124-03BHPB 5124-05BHPB
J 2002	P1090427	Connector	
	Q5000050	Terminal Posts	TP-K
	RO115290	Shield Case	Shield Case Lid
	RO115300	Shield Case Lid	

C 2040	K22170817	CAP. Chip	50V	0.01uF	B
C 2041	K22170817	CAP. Chip	50V	0.01uF	B
C 2042	K22170817	CAP. Chip	50V	0.01uF	B
C 2043	K40129004	AL. Electro CAP.	16V	10uF	B
C 2044	K22170805	CAP. Chip	50V	0.001uF	B
C 2045	K22170805	CAP. Chip	50V	0.001uF	B
C 2046	K22170206	CAP. Chip	50V	5pF	CH
C 2047	K22170206	CAP. Chip	50V	5pF	CH
C 2048	K22170817	CAP. Chip	50V	0.01uF	B
C 2049	K40129004	AL. Electro CAP.	16V	10uF	B
C 2050	K22170805	CAP. Chip	50V	0.001uF	B
C 2051	K22170215	CAP. Chip	50V	15pF	CH
C 2052	K22170213	CAP. Chip	50V	12pF	CH
C 2053	K22170215	CAP. Chip	50V	12pF	CH
C 2054	K22170213	CAP. Chip	50V	12pF	CH
C 2055	K22170817	CAP. Chip	50V	0.01uF	B
C 2056	K22170204	CAP. Chip	50V	3pF	CH
C 2057	K50170017	Mylar CAP.	50V	0.01uF	B
C 2058	K22170817	CAP. Chip	50V	0.01uF	B
C 2059	K22170817	CAP. Chip	50V	0.01uF	B
C 2060	K50170019	Mylar CAP.	50V	0.1uF	B
C 2061	K40129002	AL. Electro CAP.	16V	47uF	B
C 2062	K22170805	CAP. Chip	50V	0.001uF	B
C 2063	K22170817	CAP. Chip	50V	0.01uF	B
C 2064	K22170817	CAP. Chip	50V	0.01uF	B
C 2065	K22170817	CAP. Chip	50V	0.01uF	B
C 2066	K22170243	CAP. Chip	50V	220pF	CH
C 2067	K22170243	CAP. Chip	50V	220pF	CH
C 2068	K22170817	CAP. Chip	50V	0.01uF	B
C 2069	K22170208	CAP. Chip	50V	7pF	CH
C 2070	K22170817	CAP. Chip	50V	0.01uF	B
C 2071	K22170805	CAP. Chip	50V	0.001uF	B
C 2072	K22170817	CAP. Chip	50V	0.01uF	B
TC 2001	K91000147	Trimmer CAP.	6pF		
TC 2002	K91000147	Trimmer CAP.	6pF		
L 2001	L1190312	M. RFC	0.22uH		
L 2002	L1020680	RFC			
L 2003	L1190236	M. RFC	2.2uH		
L 2004	L0021634	Coil			
L 2005	L1190236	M. RFC	2.2uH		
L 2006	L1190236	M. RFC	2.2uH		
L 2007	L1190329	M. RFC	33uH		
L 2008	L1020680	RFC			
L 2009	L1190329	M. RFC	33uH		
L 2010	L1190329	M. RFC	33uH		
L 2011	L1190329	M. RFC	33uH		
L 2012	L1190322	M. RFC	3.9uH		
L 2013	L0021634	Coil			
L 2014	L1190322	M. RFC	3.9uH		
L 2015	L1190329	M. RFC	33uH		
L 2016	L1190089	M. RFC	1.0uH		
L 2017	L1190329	M. RFC	33uH		
L 2018	L1190329	M. RFC	33uH		
L 2019	L1190329	M. RFC	33uH		
L 2020	L1190329	M. RFC	33uH		
L 2021	L1190131	M. RFC	1.8uH		
T 2001	L0020907	Coil	145MHz		
T 2002	L0021646	Coil	132MHz		

NOTE